

VENUE D-Show® Guide

and VENUE D-Show® Software Version 2.8.1

Digidesign

2001 Junipero Serra Boulevard
Daly City, CA 94014-3886 USA

Technical Support (USA)

Visit the Digidesign Online Support Center at
www.digidesign.com/support

Product Information

For company and product information,
visit us on the web at www.digidesign.com

Legal Notices

This guide is copyrighted ©2009 by Digidesign, a division of Avid Technology, Inc. (hereafter "Digidesign"), with all rights reserved. Under copyright laws, this guide may not be duplicated in whole or in part without the written consent of Digidesign.

003, 003 Rack, 96 I/O, 96i I/O, 192 Digital I/O, 192 I/O, 888|24 I/O, 882|20 I/O, 1622 I/O, 24-Bit ADAT Bridge I/O, AudioSuite, Avid, Avid DNA, Avid Mojo, Avid Unity, Avid Unity ISIS, Avid Unity MediaNetwork, Avid Xpress, AVoption, AVoption|V10, Beat Detective, Bruno, C|24, Command|8, Control|24, D-Command, D-Control, D-Fi, D-fx, D-Show, DAE, Digi 002, Digi 002 Rack, DigiBase, DigiDelivery, Digidesign, Digidesign Audio Engine, Digidesign Intelligent Noise Reduction, Digidesign TDM Bus, DigiDrive, DigiRack, DigiTest, DigiTranslator, DINR, DV Toolkit, EditPack, Eleven, Impact, Interplay, M-Audio, MachineControl, Maxim, Mbox, MediaComposer, MIDI I/O, MIX, MultiShell, OMF, OMF Interchange, PRE, ProControl, Pro Tools M-Powered, Pro Tools, Pro Tools|HD, Pro Tools LE, QuickPunch, Reel Tape, Reso, Reverb One, ReVibe, RM1, RM2, RTAS, Smack!, SoundReplacer, Sound Designer II, Strike, Structure, SYNC HD, SYNC I/O, Synchronic, TL Space, Velvet, X-Form, and Xpand! are trademarks or registered trademarks of Digidesign and/or Avid Technology, Inc. All other trademarks are the property of their respective owners.

Product features, specifications, system requirements, and availability are subject to change without notice.

Guide Part Number: 9322-61363-00 REV A 05/09

Comments or suggestions regarding our documentation?
email: techpubs@digidesign.com

Communications & Safety Regulation Information

Compliance Statement

The model VENUE D-Show complies with the following standards regulating interference and EMC:

- FCC Part 15 Class B
- EN55103-1 E3
- EN55103-2 E3
- AS/NZS 3548 Class B
- CISPR 22 Class B

Radio and Television Interference

This equipment has been tested and found to comply with the limits for a Class B digital device, pursuant to Part 15 of the FCC Rules.

DECLARATION OF CONFORMITY

We, Digidesign, 2001 Junipero Serra Boulevard
Daly City, CA 94014-3886, USA
650-731-6300

declare under our sole responsibility that the product
VENUE D-Show

complies with Part 15 of FCC Rules.

Operation is subject to the following two conditions: (1) this device may not cause harmful interference, and (2) this device must accept any interference received, including interference that may cause undesired operation.

Communication Statement

NOTE: This equipment has been tested and found to comply with the limits for a Class B digital device, pursuant to Part 15 of the FCC Rules. These limits are designed to provide reasonable protection against harmful interference in a residential installation. This equipment generates, uses, and can radiate radio frequency energy and, if not installed and used in accordance with the instructions, may cause harmful interference to radio communications. However, there is no guarantee that interference will not occur in a particular installation. If this equipment does cause harmful interference to radio or television reception, which can be determined by turning the equipment off and on, the user is encouraged to try and correct the interference by one or more of the following measures:

- Reorient or locate the receiving antenna.
- Increase the separation between the equipment and receiver.
- Connect the equipment into an outlet on a circuit different from that to which the receiver is connected.
- Consult the dealer or an experienced radio/TV technician for help.

Any modifications to the unit, unless expressly approved by Digidesign, could void the user's authority to operate the equipment.

Canadian Compliance Statement:

This Class B digital apparatus complies with Canadian ICES-003

Cet appareil numérique de la classe B est conforme à la norme NMB-003 du Canada

Australian Compliance



CE Compliance Statement:



Digidesign is authorized to apply the CE (Conformité Européenne) mark on this compliant equipment thereby declaring conformity to EMC Directive 89/336/EEC and Low Voltage Directive 73/23/EEC.

Input Rating

I/P: 100-120V~/220-240V~, 50/60 Hz, 200W

Safety Statement

This equipment has been tested to comply with USA and Canadian safety certification in accordance with the specifications of UL Standards: UL60065 7th /IEC 60065 7th and Canadian CAN/CSA C22.2 60065:03. Digidesign Inc., has been authorized to apply the appropriate UL & CUL mark on its compliant equipment.

Warning



Important Safety Instructions

- 1) Read these instructions.
 - 2) Keep these instructions.
 - 3) Heed all warnings.
 - 4) Follow all instructions.
 - 5) Do not use this equipment near water.
 - 6) Clean only with dry cloth.
 - 7) Do not block any ventilation openings. Install in accordance with the manufacturer's instructions.
 - 8) Do not install near any heat sources such as radiators, heat registers, stoves, or other equipment (including amplifiers) that produce heat.
 - 9) Do not defeat the safety purpose of the polarized or grounding-type plug. A polarized plug has two blades with one wider than the other. A grounding type plug has two blades and a third grounding prong. The wide blade or the third prong are provided for your safety. If the provided plug does not fit into your outlet, consult an electrician for replacement of the obsolete outlet.
 - 10) Protect power cords from being walked on or pinched particularly at plugs, convenience receptacles, and the point where they exit from the equipment.
 - 11) Only use attachments/accessories specified by the manufacturer.
 - 12) Use only with a cart, stand, tripod, bracket, or table specified by the manufacturer, or sold with the equipment. When a cart is used, use caution when moving the cart/equipment combination to avoid injury from tip-over.
 - 13) Unplug this equipment during lightning storms or when unused for long periods of time.
 - 14) Refer all servicing to qualified service personnel. Servicing is required when the equipment has been damaged in any way, such as power-supply cord or plug is damaged, liquid has been spilled or objects have fallen into the equipment, the equipment has been exposed to rain or moisture, does not operate normally, or has been dropped.
 - 15) The equipment shall not be exposed to dripping or splashing and no objects filled with liquids (such as vases) shall be placed on the equipment.
- Warning!** To reduce the risk of fire or electric shock, do not expose this equipment to rain or moisture.
- 16) The equipment should be connected to a properly-grounded (earthed) receptacle.
 - 17) The main power switch is located on the back panel. It should remain accessible after installation.
 - 18) The mains plug is used as the disconnecting device and shall remain readily operable.
 - 19) The equipment shall be used at a maximum ambient temperature of 40° C.
 - 20) **CAUTION!** Danger of explosion if battery is incorrectly replaced. Replace only with the same or equivalent type.

Contents

Part I Overview and Installation

Chapter 1. Introduction to VENUE D-Show	3
VENUE D-Show Features	3
System Components	5
VENUE D-Show Expansion Options	6
Operational Requirements	7
Connection Requirements	7
Registration	8
Conventions Used in This Guide	8
About www.digidesign.com	8
Chapter 2. Configuring and Connecting D-Show	9
Unpacking and Assembling VENUE D-Show	9
Determining Control Surface Layout	9
Connections for VENUE D-Show Systems	11
Console Connections	17
Powering Up the System	18
Powering Down the System	18
Enabling a Second Stage Rack	18
Digital Inputs and Sample Rate Conversion	19

Part II System Description

Chapter 3. VENUE D-Show Control Overview	23
D-Show Main Unit and Sidecar Top Panels	23
Input Channels and Faders	24
Assignable Channel Section (ACS)	28
Assignable Output Encoders	30
Assignable Output Faders	31
Master and Global Controls	31
Meter Bridge	32
Trackball and View Mode Controls	32

Chapter 4. Basic Commands and Modes	33
Control Overview	33
Config Mode and Show Mode	34
System Lock	34
Global Modifier Switches	35
Software Screen Pages and Tabs	36
Chapter 5. Navigating and Selecting Channels	39
Banking Input Channels and FX Returns	39
Banking the Output Faders and Output Encoders	43
Selecting and Targeting Channels	43
Screen Controls	45
Screen Shortcuts	46
Input Channel Presets	49
Chapter 6. Options	51
System	51
Devices	53
Other Options and Settings	53
Part III Signal Routing	
Chapter 7. Inputs and Input Routing	63
Configuring Inputs	63
Assigning Input Sources to Channels	65
Routing Input Channels	65
Using Built-In Dynamics and EQ	67
Using Inserts on Channels	68
Adjusting Input Controls	70
Using Input Direct	73
Chapter 8. Outputs and Output Routing	75
Configuring Outputs	75
Assigning Busses to Hardware Outputs	77
Routing Group Outputs to the Mains Busses	77
Using Inserts on Output Busses	78
Adjusting Output Controls	80
Adjusting Main Bus Controls	81
Direct Outputs	83
Matrix Mixers	83
Personal Q Mixers	84
Assigning and Using VCAs	84

Chapter 9. Groups	87
Configuring Group Busses	87
Routing Inputs to Group Busses	87
Routing Group Outputs to the Main Busses	87
Managing Group Bus Assignments	88
Group Bus Signal Flow Options	90
Adjusting Group Bus Output Controls	90
Simple and Expert Operational Modes	91
Chapter 10. Aux Sends and Variable Groups	93
Configuring Aux and Variable Group Busses	93
Routing Inputs to Aux Busses	94
Routing Aux Busses to Outputs and Plug-Ins	95
Adjusting Aux Send Controls	95
Managing Aux Bus Assignments	96
Chapter 11. Matrix and Personal Q Mixers	99
Matrix Mixers	99
Personal Q Mixers	100
Configuring Matrix and PQ Mixers	101
Adjusting Matrix and PQ Mixer Input Controls	104
Adjusting Matrix and PQ Mixer Output Controls	105
Snapshot Data and Parameters for Matrix Mixers	106
Working with a PQ Controller	106
Chapter 12. Patchbay	107
Accessing the Patchbay	107
Overview of the Patchbay	107
Navigating the Patchbay	109
Assigning Channels in the Patchbay	110
Warning when Stealing Inputs or Outputs in the Patchbay	111
VENUE System Information Export	112
Patch List Export	113
Chapter 13. Metering	115
Channel Meters	115
ACS Section Dynamics Meters	117
Meter Bridge	117
Metering Options	119

Chapter 14. Solo and Monitor Busses	121
Solo Bus Modes	121
Selecting a Solo Mode	121
Solo Operation Options	122
Solo Bus Operation	123
Solo Safing Channels	123
Monitor Bus Operation	124
Talkback, 2-Track and Oscillator Controls	127
Routing the Oscillator	130
Chapter 15. Muting and Mute Groups	131
Muting	131
Mute Groups	131
Function Switches	133
Part IV Processing	
Chapter 16. Dynamics	137
Built-In Compressor/Limiter	137
Built-In Expander/Gate	138
Adjusting Dynamics	138
Channel Modes Affecting Dynamics	140
Dynamics Settings and Presets	141
Side-Chain Keys and Filters	141
Chapter 17. EQ	143
Built-In EQ Parameters	143
Adjusting EQ	144
Channel Modes Affecting EQ	147
Graphic EQ for Outputs	147
EQ Settings and Presets	148
Chapter 18. Plug-Ins	151
Installing and Authorizing Plug-Ins	151
Managing Plug-Ins on the System	153
Overview of Working with Plug-Ins	155
Plug-In Racks	156
Assigning and Routing Plug-Ins	159
Adjusting Plug-Ins	162
Plug-In Presets and Snapshots	164
Plug-In DSP Usage	165
Plug-In Levels	165
Plug-In Latency and Processing Delay	166
Chapter 19. Hardware Inserts	167
Assigning Hardware Inserts to Channels	167

Part V Shows

Chapter 20. Shows and File Management	171
Creating Shows	171
Loading Shows	172
Working with Presets	173
Transferring Settings, Shows and Presets	175
Undoing Changes Using the History Feature	176
Chapter 21. Snapshots	177
Snapshots Page	177
Snapshot Controls on the Console	180
Snapshots List	181
Creating Snapshots	183
Recalling Snapshots	184
Recall Safe and Channel Automation Safe	185
Managing Snapshots	188
Making Changes to Snapshots	190
Preview Mode	192
Undoing Snapshot Commands	195
Disabling Snapshots	195
Adding MIDI Messages to Snapshots	195
Adding Tempo Data to Snapshots	196
Adding Plug-In Data to Snapshots	197
Snapshot Options	199
Snapshot Data Types and Parameters	201
Chapter 22. Events	203
Introduction	203
The Events Window	204
Creating Events	206
Creating Triggers	208
Creating Actions	210
Testing Events	211
Resetting Events	211
Snapshots and Events	212
Default Settings, Templates and Examples	213
Tap Tempo for Plug-ins	214
Trigger Types	216
Action Types	217
Chapter 23. Synchronization	219
Automating Recall of Snapshots with MIDI Time Code	219
Remote Control of Snapshot Recall	221
Triggering of External Devices on Snapshot Recall	222
Sending MIDI Messages on Snapshot Recall	222
Synchronizing with Word Clock and Digital Audio Input	222

Chapter 24. Using the Standalone Software	223
System Requirements	223
Installing the Standalone Software	223
Simulating a VENUE Configuration	224
Transfer and Filing Quick Start	224
Exporting System Information and Patchbay Information	226

Part VI Specifications

Chapter 25. Mechanical Specifications	229
--	-----

Chapter 26. Audio Specifications	233
---	-----

Chapter 27. Signal Flow Diagrams	235
---	-----

VENUE D-Show Systems: Input Signal Flow	235
---	-----

VENUE D-Show Systems: Output Signal Flow	236
--	-----

Chapter 28. Troubleshooting	237
--	-----

Problem Solving	237
-----------------------	-----

In Case of System Failure	239
---------------------------------	-----

Performing a Soft Reset	241
-------------------------------	-----

Hardware Monitoring Window	242
----------------------------------	-----

Resetting Hardware Components	242
-------------------------------------	-----

Using the System Restore CD to Update or Restore the System	243
---	-----

Part VII Reference

Chapter 29. Console Reference	247
--	-----

VENUE D-Show Console	247
----------------------------	-----

D-Show Sidecar	249
----------------------	-----

Chapter 30. ECx	251
------------------------------	-----

ECx Capabilities and Features	251
-------------------------------------	-----

ECx Components	251
----------------------	-----

System Requirements	251
---------------------------	-----

Installing ECx Host Software	251
------------------------------------	-----

Overview of ECx Setup and Configuration	253
---	-----

Connecting a Computer Directly to VENUE	253
---	-----

Connecting a Wireless Router or WAP to VENUE	253
--	-----

Setting VENUE and Client IP Addresses	254
---	-----

Establishing a Wireless Connection	257
--	-----

Enabling Remote Operation	258
---------------------------------	-----

Disconnecting ECx	259
-------------------------	-----

Changing the Ethernet Control Password	259
--	-----

Part I: Overview and Installation

Chapter 1: Introduction to VENUE D-Show

Welcome to VENUE™ D-Show, part of Digidesign's modular VENUE live sound environment. VENUE D-Show systems offer an intuitive, expandable console layout, a flexible I/O scheme, powerful digital processing, and expansion options for integrated Pro Tools recording and artist-controlled monitor mixing.

VENUE D-Show Features

The VENUE D-Show console includes one Main Unit and at least one Sidecar.



Figure 1. VENUE D-Show (Main Unit, left, and Sidecar, right)

D-Show Console and Control

- 24 bankable input channel strips (8 on Main Unit, 16 on the Sidecar), each with a touch-sensitive fader, two multi-purpose assignable rotary encoders, solo, mute and select controls
- Built-In High-Pass Filter, Dynamics and EQ processors on each input channel strip
- Level meters on each input channel strip
- Assignable Channel section (ACS) with dedicated Bus Assign, Aux Send, Direct Out, EQ and Dynamics controls.
- 8 multi-purpose Output faders strips, each with a touch-sensitive fader, one multi-purpose encoder, solo, mute and select controls
- 1 Mains fader
- Up to 24 31-band Graphic EQs available for Outputs
- Main Busses configurable as Left–Center–Right or Left–Right+Mono

Console I/O

- Talkback mic input, with gain and phantom power
- Headphone output
- USB inputs for keyboard, mouse/trackball, iLok USB Smart Keys, and USB storage devices
- VGA monitor output for software screen display
- AC power, Console Link, and console lights

D-Show Sidecar Features

- 16 input strips, each with a touch-sensitive fader, two multi-purpose rotary encoders, solo, mute, and select controls.
- Sidecar faders and encoders can be linked or unlinked from Main Unit banking.
- Up to 3 Sidecars can be connected to the Main Unit for a total of 56 bankable input strips.

VENUE D-Show System Components

VENUE D-Show Main and Sidecars are used with one VENUE FOH Rack combined with one or more VENUE Stage Racks.



FOH Rack I/O and Features

The FOH Rack provides the following I/O, processing, and control features for the mix position.

Audio I/O

- 8 pairs of analog I/O for hardware inserts, or for input and output of line-level material from the mix position.
- Analog and digital (AES or S/PDIF) 2-Track inputs and outputs.
- Monitor outputs for mix position near field monitors.
- Intercom mic input

Synchronization and Control I/O

- MIDI In and Out ports, providing 16 channels of MIDI input and 16 channels of MIDI output.
- Word clock I/O for digital clock synchronization.
- USB 2.0 ports for USB disks, iLoks, and other USB devices.
- 100 BaseT ECx port for Ethernet-based remote control.
- Snake connectors to enable primary and redundant (if applicable) connection to the VENUE Stage Rack.

CPU, DSP, and System Drives

FOH Rack houses the CPU, DSP, hard drive and CD-ROM drive that run the VENUE D-Show software on your VENUE system. System software is installed at the factory. The CD-ROM drive lets you update or restore your system software, and install compatible plug-ins from their installer discs. A standard FOH Rack includes three Mix Engine cards, which provide DSP for plug-ins and mixing. You can add up to two additional Mix Engine cards, up to a maximum of five.

Redundant Power Supply Units (PSUs)

Each FOH Rack comes with two universal (100V to 240V nominal, 50–60 Hz) PSUs with auto redundant failover and LED status indication.

Stage Rack I/O and Features

Stage Racks are used with an FOH Rack, and provide all stage audio I/O for VENUE D-Show systems. Up to two Stage Racks can be used simultaneously, supporting up to 96 total inputs.

Audio I/O

- 48 inputs with remotely controllable mic preamps and individually selectable phantom power.
- 8 analog output channels; expandable up to 48 analog or digital outputs per Stage Rack.

Synchronization and Control I/O

- Snake connectors to enable primary and redundant (if applicable) connection to a VENUE FOH Rack.

Mix Rack and VENUE D-Show

As an alternative to FOH Rack and Stage Racks, you can purchase a VENUE Mix Rack and use it with D-Show Main and Sidecar units. The Mix Rack provides the following stage and mix position I/O, processing, and other features in a single rack unit:

Stage I/O

- 48 inputs with mic preamps. Each fully recallable input provides phantom power and input gain.
- 16 line level analog outputs (expandable up to 32) to connect to mains and monitors.

FOH I/O

- 8 pairs of analog I/O for hardware inserts, or for input and output of line-level material from the mix position.
- Analog and digital (AES or S/PDIF) 2-Track inputs and outputs.
- Com mic input, with gain control and phantom power.
- Monitor outputs for mix position near field monitors.

Synchronization and Control I/O

- MIDI In and Out ports, providing 16 channels of MIDI input and 16 channels of MIDI output.
- Word clock I/O for digital clock synchronization.
- USB 2.0 ports for USB disks, iLoks, and other USB devices.
- 100 BaseT Ethernet (ECx) port for remote control.

CPU, DSP, and System Drives

Mix Rack houses the CPU, DSP, hard drive and CD-ROM drive that run the VENUE D-Show software on your VENUE system. System software is installed at the factory. The CD-ROM drive lets you update or restore your system software, and install compatible plug-ins from their installer discs. A standard Mix Rack includes two Mix Engine cards providing DSP for plug-ins. You can add one additional Mix Engine card, for a maximum of three.

Redundant Power Supply Units (PSUs)

Each Mix Rack comes with two universal (100V to 240V nominal, 50–60 Hz) PSUs with auto redundant failover and LED status indication.

 For more information, see the VENUE Mix Rack Guide.

System Components

Included Components

Each VENUE D-Show system includes the following:

- D-Show Main Unit console with AC power cord
- Sidecar unit with AC power cord and Console Link cable
- Monitor mount for VGA screen (screen not included)
- Trackball mount (trackball not included)
- VENUE Mouse Pad
- VENUE D-Show Guide
- Two (2) console lights
- Protective Dust Cover
- Racks (see next)

Racks, Software CDs, iLoks, and Cables

Each FOH Rack includes:

- System Restore CD
- ECx Ethernet Control Software Installer CD
- Standalone Software Installer CD
- iLok USB Smart Key (for storing plug-in authorizations)
- Plug-in installer discs (if any) with pre-authorized iLok
- Two (2) IEC power cables
- One FOH Link cable for connection to a VENUE console

Each Stage Rack includes:

- Two (2) IEC power cables

Additional Required Components

The following components must be purchased separately:

- Video Display (15-inch or greater flat-panel VGA display recommended; 1024x768 minimum resolution).
- USB keyboard and trackball/mouse (Windows compatible)

Digital Snake Cable

- The connection between FOH Rack and Stage Rack requires a Digital Snake cable. This cable can be purchased directly from Digidesign or assembled by your preferred vendor.

Optional Components

The following components are optional, and must be purchased separately:

- USB flash disk (or other portable USB storage device for transfer of Show data; 512 MB or larger recommended)
- Near-field monitor speakers for mix position monitoring
- Headphones with 1/4-inch jack
- Dynamic or condenser microphone and XLR mic cable (for Talkback)
- Footswitches (up to 2)
- MIDI cables (for connecting external MIDI devices)
- BNC cables (for connecting Word clock between the VENUE system and external digital devices)

VENUE D-Show Expansion Options

The following options can be added to VENUE D-Show systems. For details on all VENUE systems and options, visit the Digidesign website (www.digidesign.com).

FOH Rack Options

I/O Options

An FOH Input/Output (IOx) card can be added to the FOH Rack, providing an additional 8 channels of analog I/O and 8 channels of AES/EBU Digital I/O.

DSP Expansion Options

Additional Mix Engine cards can be added to the FOH Rack (up to a maximum of 5 Mix Engine cards) for increased mixing and plug-in processing capacity.

Snake Card Expansion

Adding a second Snake Card to the FOH Rack lets you add a second Stage Rack to your VENUE system, giving you a total of up to 96 channels of Stage I/O.

Record and Playback Options

FWx Record/Playback Option This FireWire-based option lets you record or play back up to 18 channels of audio with a Pro Tools LE™ system.

HDx Record/Playback Option This option lets you record or play back up to 128 channels of audio directly with a Pro Tools|HD® system.



Only a single HDx Card can be installed in a Mix Rack. Only one Record and Playback Option can be installed at any one time (either HDx or FWx).

Stage Rack Options

I/O Options

Each Stage Rack supports up to 6 input cards and 6 output cards, for a total of up to 48 inputs and up to 48 outputs (analog or digital). Stage Rack I/O options include the following:

SRI Analog Mic/Line Input Card that provides 8 analog mic/line level inputs

SRO Analog Output Card that provides 8 analog line level outputs

DSI Digital Output Card that provides 8 digital outputs (AES or ADAT)

DSO Digital Output Card that provides 8 digital outputs (AES or ADAT)

Personal Q The Personal Q (PQ) monitoring system lets performers adjust their monitor mix being sent from VENUE using a PQ Controller unit. The Stage rack can accommodate one PQ Rack and up to 8 PQ Controllers.

A-Net Output ANO A-Net Output Card that provides 16 channels of A-Net output compatible with Aviom® Pro16™ Series devices for personal monitoring.

Additional Stage Rack

A second Stage Rack can be added for a total of up to 96 inputs or up to 96 outputs. (A second Stage Rack requires an additional Snake card be installed in the FOH Rack.)

Redundant Digital Snake

An optional redundant Digital Snake cable can be run between the FOH Rack and each Stage Rack. This redundant Snake automatically takes over communication if the primary Snake fails.

Mix Rack Options

I/O Options

Each Mix Rack supports a maximum of 3 input cards and 2 output cards for a total of up to 48 inputs and up to 32 outputs. Mix Rack I/O options include:

AI16 Analog Mic/Line Input Card that provides 16 analog mic/line level inputs

A016 Analog Output Card that provides 16 analog line level outputs

X016 Analog and Digital Output Card that provides 8 analog line level outputs, and 8 AES digital outputs.

AT16 A-Net Output Card that provides 16 channels of A-Net output compatible with Aviom® Personal Mixers and other Pro16™ Series devices.



For information on these and other Mix Rack options, see the VENUE Mix Rack Guide.

Operational Requirements

Temperature and Ventilation

VENUE units should be operated away from heat sources and with adequate ventilation.

 *Hardware monitoring and automatic warnings are provided for temperature, power and other factors. For more information, see “Hardware Monitoring Window” on page 242.*

Storage

VENUE systems should be stored and transported at temperatures not lower than 0 degrees F (–18 degrees C) and not exceeding 140 degrees F (60 degrees C).

Operation

VENUE systems should be operated at temperatures not lower than 40 degrees F (4 degrees C) and not exceeding 104 degrees F (40 degrees C).

During operation, the front and back panels of VENUE D-Show Main and Sidecar units should be exposed to ambient air. Do not block the ventilation holes on any VENUE system component.

Do not operate in direct sunlight or at extreme ambient temperatures.

Water and Moisture

VENUE units should be operated away from sources of direct moisture and should be kept clear of liquids that might spill into the units. If condensation is present on the unit, leave the unit to dry in ambient air for at least one hour before powering the unit on.

Humidity ranges for storage and operation

Storage humidity range	5% to 95%, non-condensing
Operating humidity range	20% to 80%, non-condensing

Cleaning and Maintenance

Use a dry cloth to clean the VENUE console top surface when needed. Do not apply any cleaning solutions, spray cleaners, or abrasives to the surface.

Connection Requirements

Power Connections

Each VENUE component requires its own power connection for primary and redundant power (if applicable).

Make sure your power source is correctly rated for the number of units you are connecting. A surge-protected power source (not included) is highly recommended.

VENUE D-Show power supplies are capable of operating at 50 to 60 Hz across a voltage range of 100 to 240 V.

FOH Link Connection

Connection between the VENUE D-Show Main Unit and the FOH Rack (or Mix Rack) is made with the provided FOH Link cable. For replacement cables, contact Digidesign Customer Service or your VENUE dealer.

 *For more information, see the VENUE FOH Rack Guide.*

Audio Connections

All VENUE system analog audio inputs and outputs (except Headphones) are balanced XLR or balanced 1/4-inch connections.

All external digital audio inputs and outputs are AES/EBU (XLR), ADAT (Lightpipe) or S/PDIF (RCA) connections.

 *For more information on audio connectors and specifications, see Chapter 26, “Audio Specifications.”*

Snake Connections

Connection between the FOH Rack and the Stage Rack is made with the Digital Snake cable (not included). Cables can be purchased directly from Digidesign or assembled by your preferred vendor. For Snake cable specifications and requirements, see the *VENUE Stage Rack Guide*.

For systems that instead utilize a Mix Rack, an analog multi-core snake (not provided) is recommended to bring inputs from stage to the mix position, and return outputs back to the stage for monitor and mains amplification.

Registration

Review the enclosed Digidesign Registration Information Card and follow the instructions on it to quickly register your purchase online. Registering your purchase is the only way you can be eligible to receive complimentary technical support and future upgrade offers. This is one of the most important steps you can take as a new user.

Conventions Used in This Guide

Digidesign guides use the following conventions to indicate menu choices and key commands:

Convention	Action
Options > System	Click the Options tab, then click the System sub-tab
Control+N	Hold down the Control key and press the N key
Control-click	Hold down the Control key and click the mouse button
Right-click	Click with the right mouse button

The names of Commands, Options, and Settings that appear on-screen are in a different font.

The following symbols are used to highlight important information:

 *User Tips are helpful hints for getting the most from your system.*

 *Important Notices include information that could affect your data or the performance of your system.*

 *Shortcuts show you useful keyboard or mouse shortcuts.*

 *Cross References point to related sections in this guide and other Digidesign guides.*

About www.digidesign.com

The Digidesign website (www.digidesign.com) is your best online source for information to help you get the most out of your Pro Tools system. The following are just a few of the services and features available.

Product Registration Register your purchase online.

Support and Downloads Contact Digidesign Technical Support or Customer Service; download software updates and the latest online manuals; browse the Compatibility documents for system requirements; search the online Answerbase or join the worldwide VENUE community on the Digidesign User Conference.

Training and Education Study on your own using courses available online or find out how you can learn in a classroom setting at a certified Pro Tools training center.

Products and Developers Learn about Digidesign products; download demo software or learn about our Development Partners and their plug-ins, applications, and hardware.

News and Events Get the latest news from Digidesign or sign up for a Pro Tools demo.

Pro Tools Accelerated Videos Watch the series of free tutorial videos. Accelerated Videos are designed to help you get up and running with Pro Tools and its plug-ins quickly.

Live Sound Webinars Watch free tutorial videos and VENUE-specific webinars to learn from the experts.

To learn more about these and other resources available from Digidesign, visit the Digidesign website (www.digidesign.com).

Chapter 2: Configuring and Connecting D-Show

The chapter shows how to connect the components of a VENUE D-Show system.

Unpacking and Assembling VENUE D-Show

- ◆ Remove all components from their shipping packaging.
- ◆ Place the Main Unit and Sidecar consoles on a table or other stable surface that leaves full access to their front and back panel connectors and mounts.
- ◆ Make sure all components are free of any bags, padding or other materials.
- ◆ Keep cables and other included items organized, making sure to keep them with their associated component after unpacking.

Determining Control Surface Layout

The D-Show Main Unit and Sidecar can be placed in any order, and the input channel strip order configured accordingly. Banking can be configured to affect all connected units globally, or configured for split (local) banking of faders and encoders.

Standard System Layout

On a D-Show system with one Main Unit and a single Sidecar on the left, input channel strips 1–16 appear by default on the Sidecar module, and channel strips 17–24 appear on the Main Unit.

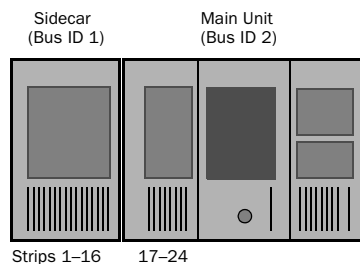

Input channel strip numbering on a standard system

You can place the Sidecar on the other side of the Main Unit, and customize the order of input channel strips by changing the Bus IDs of the units. See “Setting Control Surface Bus IDs” on page 10.

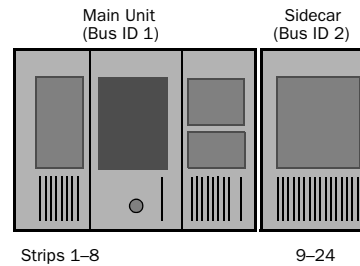

Alternative input channel strip numbering on a standard system

Expanded System Layout

On expanded D-Show systems with more than one Sidecar, by default, input channel strips 1–16 appear on the leftmost Sidecar and progress to the right.

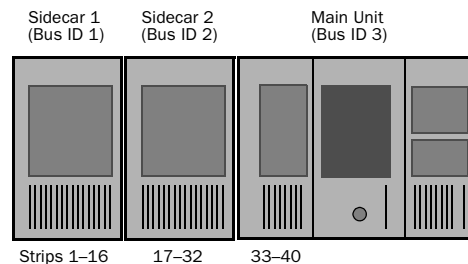

Input channel strip numbering on an expanded system

You can place Sidecars on either or both sides of the Main Unit, and customize the order of input channel strips by changing the Bus IDs of the units. See “Setting Control Surface Bus IDs” on page 10.

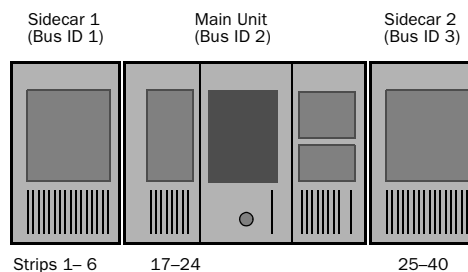

Alternative input channel numbering on an expanded system

Setting Control Surface Bus IDs

All units have a Bus ID selector in the upper left of the control surface top panel. Input channel strip numbering is determined by the Bus ID setting on each unit. Lower-numbered bus IDs correspond to lower-numbered input channels.

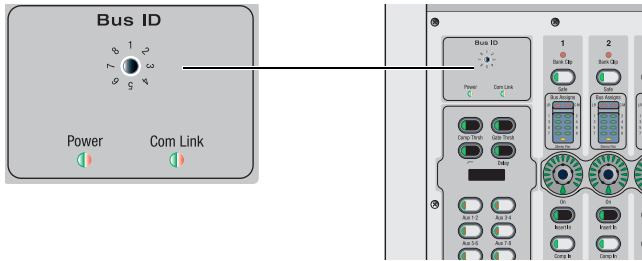

Bus ID selector

To set the Bus ID on a unit:

- With a small flat-head screwdriver, set the Bus ID as follows:
 - Set the ID to 1 to have input channel numbering start on that unit. Typically, this will be the leftmost unit in your system.
 - Set the ID to 2 on the unit you want to have the second set of input faders. For example, on a standard D-Show system (one Sidecar and one Main Unit) where the Sidecar is at the left of the Main Unit, the Main Unit should be set to Bus ID 2.
 - Set the ID of other units to match the layout of input channels.

Connections for VENUE D-Show Systems

This section describes system and audio connections between VENUE D-Show Main Unit and Sidecars, a FOH Rack, and Stage Racks.

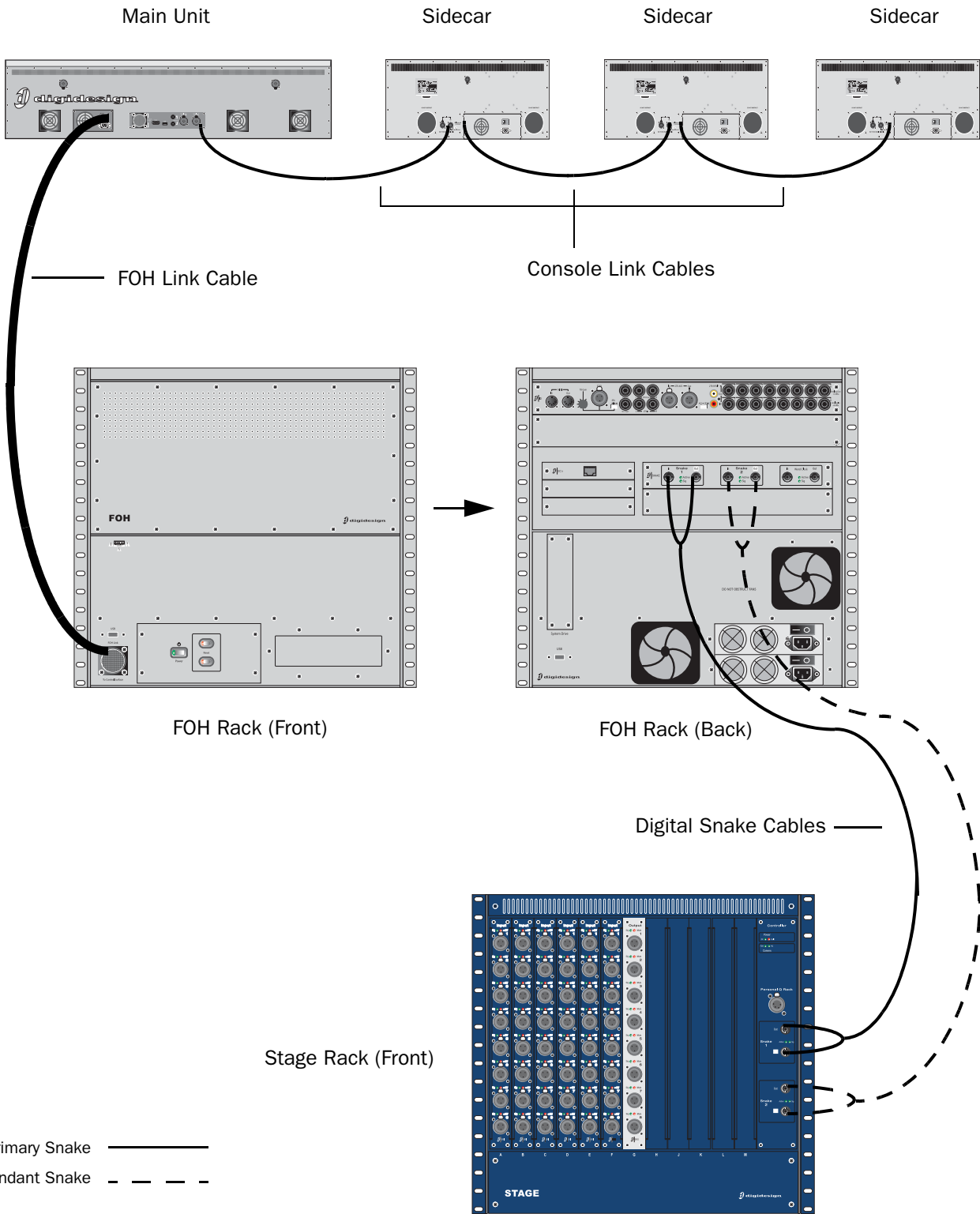

Figure 2. VENUE System system component connections

Connecting the D-Show Main Unit and Sidecars

The D-Show Main Unit and Sidecars are connected with Console Link cables (one 15-foot cable is provided with each Sidecar), which are 110-ohm AES/EBU digital cables. The maximum length permissible for each Console Link cable is 25 feet (7.6 meters). Up to three Sidecars can be connected to the “Sidecar 1–3” port on the Main Unit.

To connect the Main Unit and Sidecars:

- 1 Connect the Console Link In port on the back panel of the nearest Sidecar to the “Sidecar 1–3” port on the back panel of the Main Unit.
- 2 On the successive Sidecars, connect the Console Link In port to the Console Link Out port on the previous Sidecar.

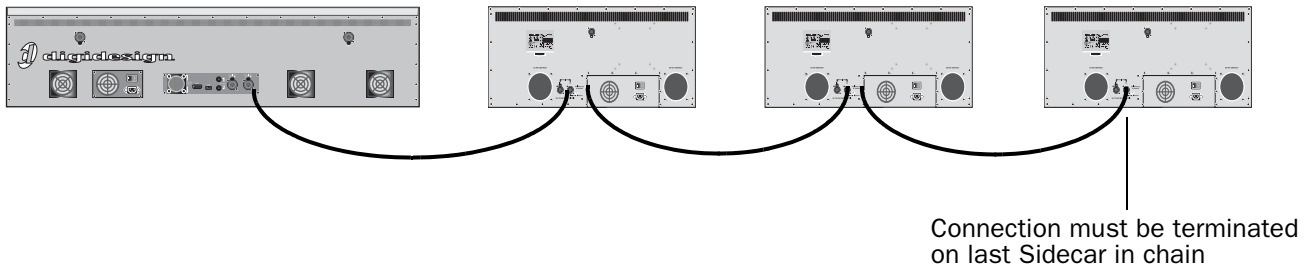

Figure 3. Console Link connections for Main Unit (left) and Sidecars (right)

- 3 On the last Sidecar only, terminate the Console Link connection with the Terminate switch.

Connecting D-Show to the FOH Rack

The D-Show Main Unit is connected to the FOH Rack with the provided FOH Link cable.

To connect the Main Unit and the FOH Rack:

- Connect the FOH Link cable to the FOH Link port on the back of the Main Unit, and to the FOH Link port on the front panel of the FOH Rack. On each end, be sure to align the notch in the connector housing with the slot in the plug, and to rotate the collar until the connector is fully latched.

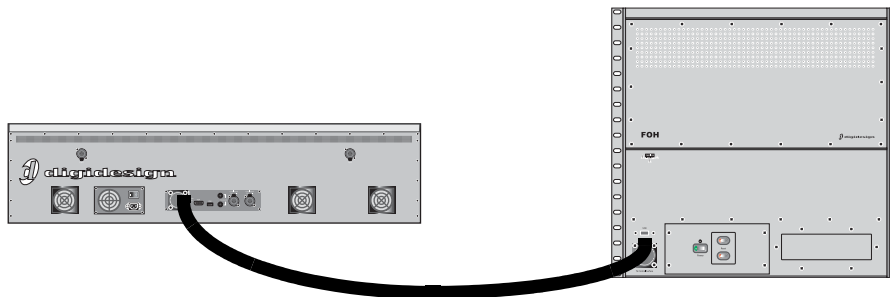



Figure 4. FOH Link connection between Main Unit (left) and FOH Rack (right)

Connecting the Stage Rack to the FOH Rack

The Stage Rack is connected to the FOH Rack with the Digital Snake cable (purchased separately).

To connect a Stage Rack to the FOH Rack:

- 1 Connect the send snake to the Stage 1 Out port of the Stage Rack, and to the Stage 1 In port on the FOH Rack.
- 2 Connect the return snake to the Stage 1 Out port on the FOH Rack, and to the Stage 1 In port on the Stage Rack.

 The connectors on Digidesign's Digital Snake cable are color coded, so that the white cable connects to the white-outlined ports.

When the system is powered up, the primary snake connection is indicated by a solid Active LED. If the Snake Signal LEDs flash, a Snake connection could not be established.

 If there are problems with the Snake connection, double check that all the BNC connectors are fully secured.

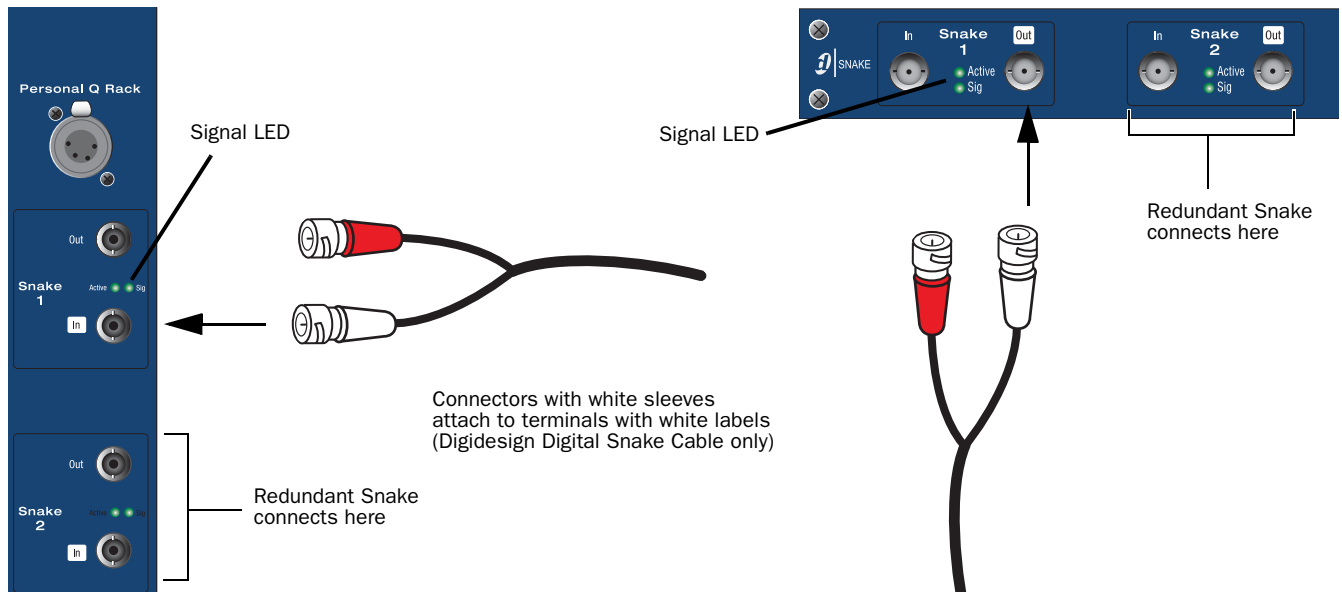



Figure 5. Detail of Digital Snake cable connection between Stage Rack (left) and FOH Rack (right)

Connecting a Second Stage Rack

 If a second Stage Rack is used, an additional Snake Card must be installed in the FOH Rack. See the Snake Card Guide for more information.

To connect a second Stage Rack:

- 1 Using a BNC cable (included with the additional Snake card), connect the Word Clock Out port on the first Snake card to the Word Clock In port on the second Snake card.

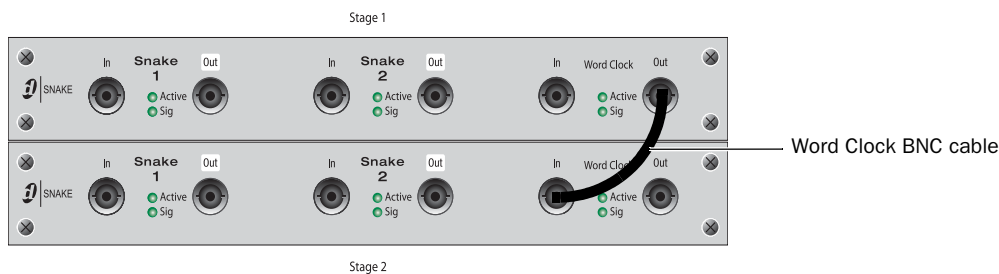

Word Clock connection between Snake cards

2 Connect the second Stage Rack to the FOH Rack with a Digital Snake cable. See “Connecting the Stage Rack to the FOH Rack” on page 13.

⚠ The primary and redundant snake cables must be the same length.

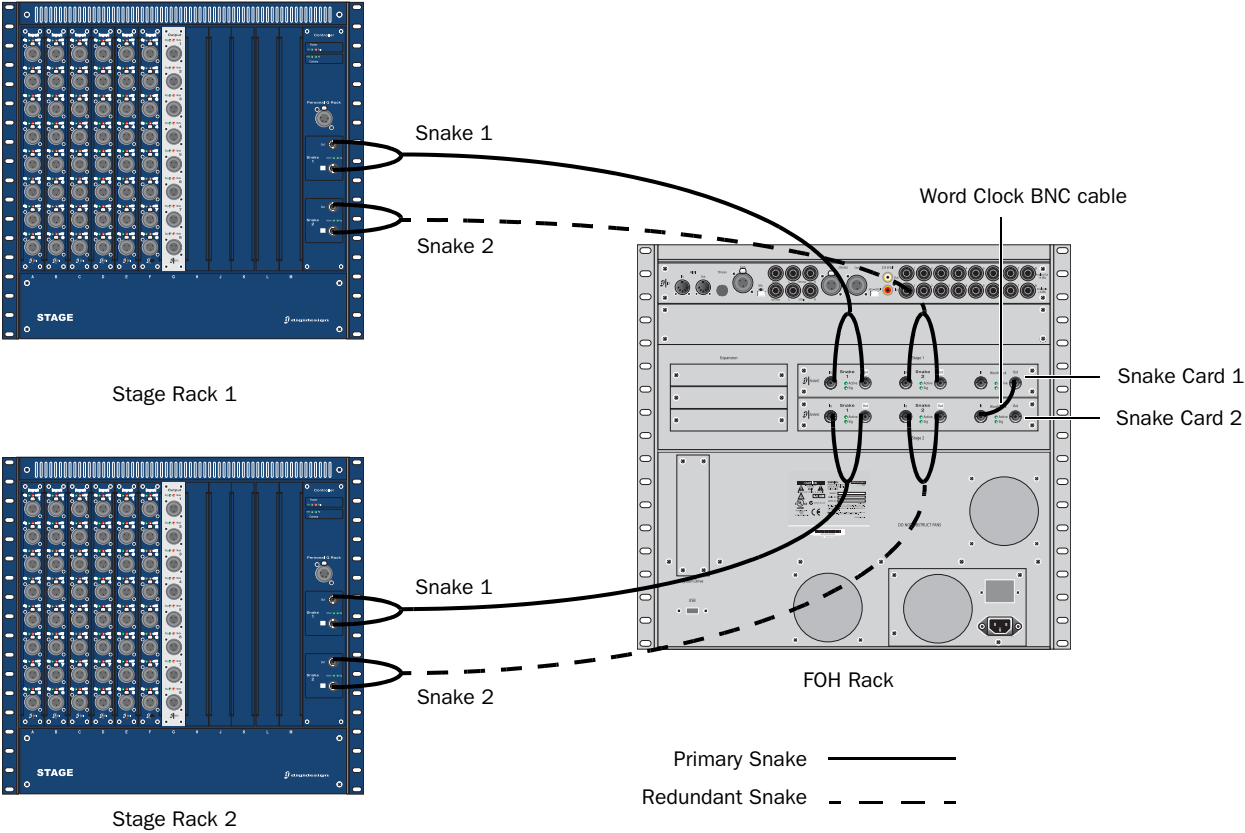

Figure 6. Digital Snake cable and word clock connections for fully redundant system with two Stage Racks

Audio Connections

Stage Rack

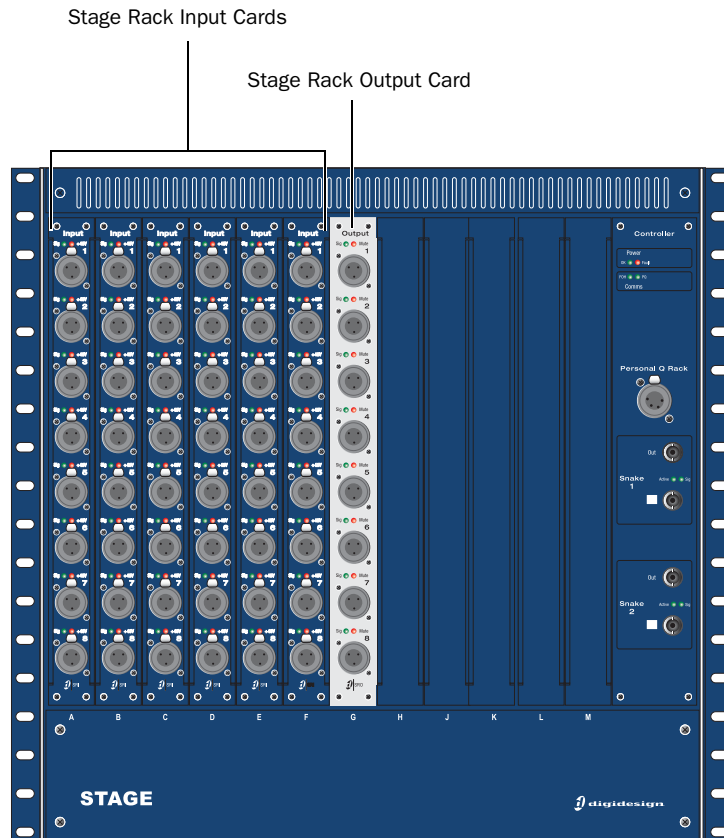

Figure 7. Audio connectors on Stage Rack

Analog Audio Inputs

(Balanced Female XLR Connectors)

- ◆ Connect analog mic-level or line-level input sources to any of the input connectors on any SRI Card.

Analog Audio Outputs

(Balanced Male XLR Connectors)

- ◆ Connect analog line-level output destinations (such as power amplifiers, crossovers, or speakers) to any of the output connectors on any SRO Card.

Digital I/O

If your Stage Rack includes a digital I/O option, see “Digital Inputs and Sample Rate Conversion” on page 19.

FOH Rack

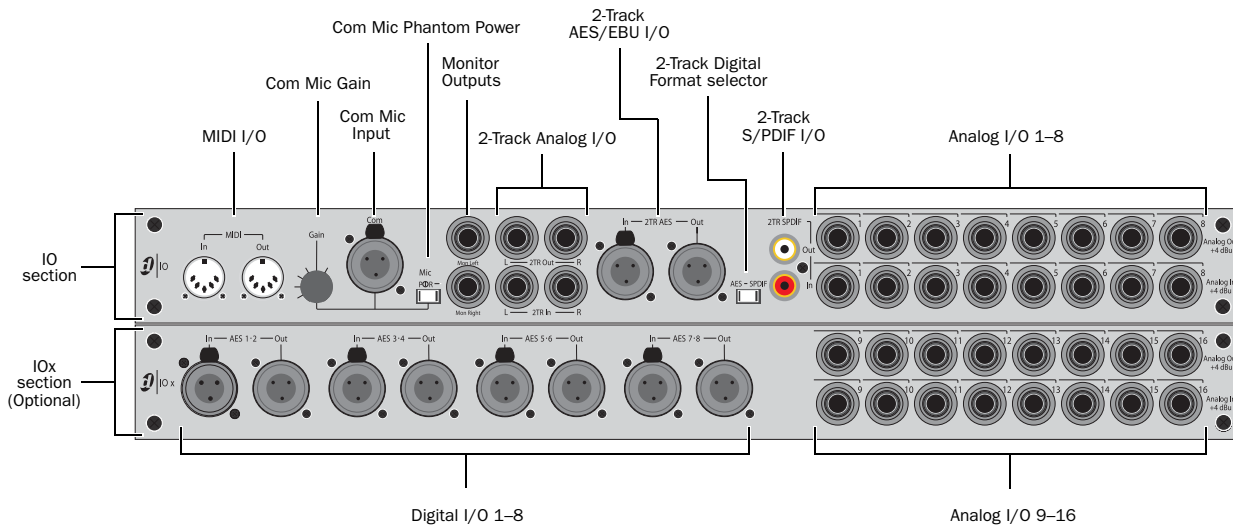

Figure 8. Audio connectors on FOH Rack, showing standard IO connectors (top) and optional IOx connectors (bottom)

Analog Inputs and Outputs

(Balanced 1/4-inch TRS Connectors)

- ◆ Connect the analog inputs and outputs of external processors to any of these 8 analog output and input pairs. (16 inputs and output pairs are available if the IOx option is installed.)
- ◆ Connect any analog output destination (such as a recording device or broadcast feed) to any of the outputs in this section.
- ◆ Connect any analog sound sources (such as a CD player) to any of the inputs in this section.

2-Track Analog Inputs and Outputs

(Balanced 1/4-inch TRS Connectors)

- ◆ Connect a 2-track analog playback source to the 2-Track analog inputs.
- ◆ Connect a 2-track analog recording device to the 2-Track analog outputs.

2-Track Digital Inputs and Outputs

(AES/EBU and S/PDIF Connectors)

- ◆ Switch the 2-Track digital I/O between AES/EBU and S/PDIF by moving the 2-Track Digital Format selector switch to the corresponding position. Only one of these digital formats may be active at a time.
- ◆ Connect a 2-channel digital playback source to the 2-Track AES/EBU or S/PDIF input.
- ◆ Connect a 2-channel digital recording device to the 2-Track AES/EBU or S/PDIF output.
- ◆ These connectors support 24-bit, 48 kHz digital signals. Input signals with other sample rates are sample-rate converted to 48 kHz.

Monitor Outputs

(Balanced 1/4-inch TRS Connectors)

- ◆ Connect a monitor amplifier or powered monitors to the Monitor Output connectors.
- ◆ The Monitor Outputs and the Headphone Output on the front of the console are fed by the Solo/Monitor bus

Com Mic Connector

- ◆ Plug a dynamic or condenser microphone, or any compatible intercom system microphone into this connector.

Com Mic Gain

- ◆ Turn the Com Mic knob to adjust overall Com Mic gain.

MIDI Input and Output

- ◆ Connect a compatible MIDI device to the MIDI In and MIDI Out ports. Snapshots receive and send MIDI commands, and generate and respond to MIDI Time Code.

Word Clock

If you are integrating digital devices with your VENUE system, make the necessary Word clock connections and settings. For details, see “Synchronizing External Digital Source Devices” on page 19.

Digital Inputs and Outputs - IOx Option only

(AES/EBU Connectors)

- ◆ Connect the two-channel digital inputs and outputs of external processors to any of the 4 AES/EBU digital output and input connectors in this section.
- ◆ These connectors support 24-bit, 48 kHz digital signals. Input signals with other sample rates are sample-rate converted to 48 kHz.

Console Connections

Talkback Mic

Talkback Mic Connector

- ◆ Plug a dynamic or condenser talkback microphone into this connector.

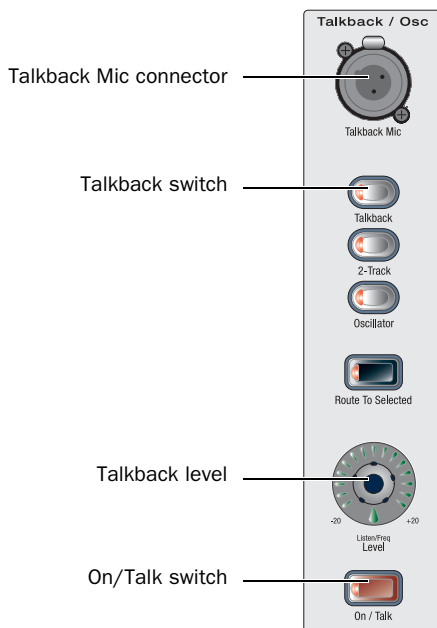

Talkback microphone connector and controls on the Main Unit

Talkback Level

- ◆ The talkback gain for this connector is fixed at 20 dB.
- ◆ Adjust talkback send level by pressing the Talkback switch in the Talkback/Osc section and turning the level knob.

Talkback Switch

- ◆ Activate talkback by pressing the On/Talk switch.

VGA Display

- ◆ Plug a compatible VGA display into this connector.



VGA Display connector

VGA display connector on back panel of the Main Unit

USB

- ◆ Plug a compatible USB keyboard and mouse/trackball into any of the USB connectors provided on the top, back, and front of the Main Unit.

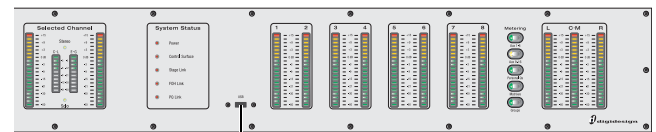

USB connector

USB connector on the meter bridge panel of the Main Unit



USB connector

USB connector on back panel of the Main Unit



USB connector

USB connector on front panel of the Main Unit

Powering Up the System

⚠ *D-Show faders move when power is turned on. Before powering up the system, make sure all fader paths on the Main Unit and Sidecars are clear of obstructions.*

Power up the system in the following sequence:

- 1 Main Unit and Sidecars
- 2 Stage Rack
- 3 Front of House Rack
- 4 Any connected computers for recording/playback options
- 5 Audio monitoring system

💡 *On units with redundant power supplies, each power supply has a separate power switch.*

Powering Down the System

Power down the system in the following sequence:

- 1 Audio monitoring system
- 2 Any connected computers for recording/playback options
- 3 Front of House Rack
- 4 Stage Rack
- 5 Main Unit and Sidecars

📄 *If at any time during setup or performance it becomes necessary to reset or restart the system, see Chapter 28, "Troubleshooting."*

Enabling a Second Stage Rack

To enable and confirm communication with the second Stage Rack:

- 1 Put the system in Config mode.
- 2 Go to the Options page and click the System tab.
- 3 Click Edit.
- 4 Select Enable Stage 2, and click Apply. The system restarts.

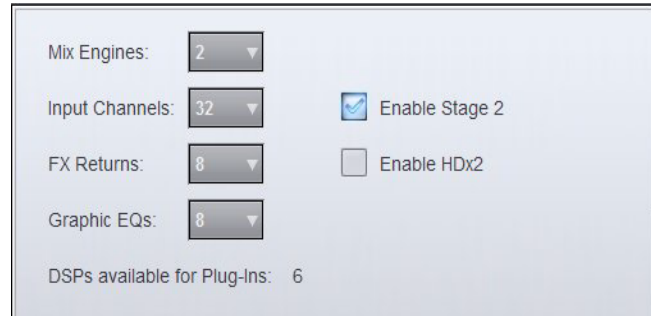

Enabling the second Stage Rack

- 5 Go to Options > Devices to view hardware status. The connection to the second Stage Rack should be displayed in the FOH Rack graphic.

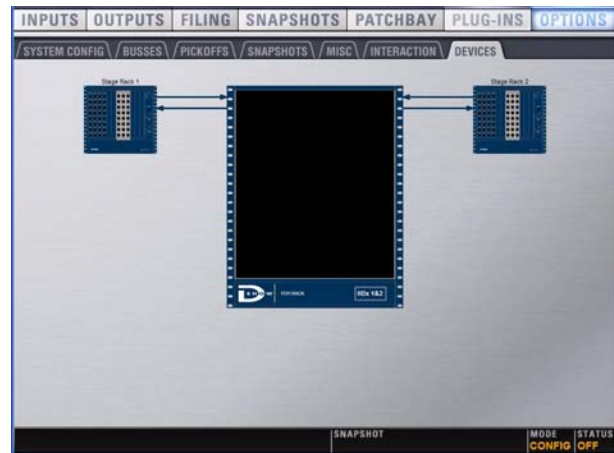

Detail of Devices page showing connection to second Stage Rack

💡 *The second Stage Rack must be enabled for the Devices tab to display the correct number of input and output cards in that unit.*

Digital Inputs and Sample Rate Conversion

This section describes how to connect and clock external digital devices to VENUE systems.

Overview

The types of digital I/O and connectivity available varies depending on your system components and their configuration:

FOH Rack VENUE FOH Racks provide numerous digital inputs and outputs, which can be expanded further by adding an IOx card. FOH Rack also provides Word clock I/O.

Stage Rack VENUE Stage Racks can be expanded by adding a DSI Digital Input card to add 8 channels of digital (AES or ADAT) input, and by adding a DSO Digital Output card for 8 channels of digital (AES or ADAT) output. DSI cards also provide Word clock I/O.

Mix Rack The VENUE Mix Rack provides a pair of digital (AES) 2-Track inputs and outputs. The Mix Rack can also be expanded to include an XO16 card, to add 8 channels of analog output and 8 channels of digital (AES) output. Mix Rack also provides Word clock I/O.

Sample Rate Conversion Latency

VENUE digital I/O (such as the DSI card) operates at the VENUE system sample rate of 48 kHz. The DSI card provides auto-detection and sample rate conversion on input, letting you connect a wide variety of digital sources without having to be concerned with synchronization and clock connections.

When sample rate conversion is enabled on DSI or other VENUE digital inputs, input signal paths will incur a small amount of latency. The following table illustrates the sample rate conversion processing delay at various sample rates.

Minimum Additional Latency due to Sample Rate Conversion

External Sample Rate	SRC Process Delay
32 kHz	1.50 ms
44.1 kHz	1.09 ms
48 kHz	1.00 ms
88.2 kHz	0.848 ms
96 kHz	0.833 ms

Sample rate conversion (SRC) can also be disabled (DSI card only). This provides the lowest possible input path latency, but requires that care be taken to synchronize the source and other devices accordingly (see “Synchronizing External Digital Source Devices” on page 19).

Even when SRC is disabled, connecting an unsynchronized device to a DSI input causes SRC to automatically be re-enabled. This lets audio continue passing without interruption.

To manually disable Sample Rate Conversion:

- 1 Click the Inputs tab and navigate to the input channel being fed from a DSI input.
- 2 Click the channel’s SRC OFF button until it turns off.

Auto-Detecting

The DSI card automatically detects whether an external device connected to a DSI input is synchronized to the VENUE system. Here, “synchronized” means the device is running at 48 kHz, and is clocked to the VENUE system (see “Synchronizing External Digital Source Devices” on page 19). In this case, no sample rate conversion is required on input.

If the external device is not synchronized, the VENUE system automatically engages sample rate conversion on those inputs *even if sample rate conversion was manually defeated*. The SRC LED flashes on the DSI card, and a message appears on-screen to indicate this condition.

 SRC status is not affected when an input channel is reset via right-click “Reset Strip” commands.

Sample rate conversion can be enabled or disabled manually for digital inputs, as follows:

- ◆ When using AES inputs on DSI cards, sample rate conversion can be enabled or disabled for each pair of inputs.
- ◆ When using ADAT (Optical) inputs on DSI cards, sample rate conversion can be enabled or disabled for all 8 channels. Enabling or disabling SRC on any ADAT channel enables or disables all other ADAT channels on that DSI card.

Switching input Source between AES and ADAT (Optical) ports retains the last sample rate conversion setting for that input type and channel (AES channel pairs only).

 Automatic detection and enabling of sample rate conversion is always in effect and will engage sample rate conversion whenever a mismatch is detected at a DSI input, even when sample rate conversion is manually defeated for that input.

Synchronizing External Digital Source Devices

When an external device is running at 48 kHz and clocked to VENUE, disabling sample rate conversion on the (VENUE system) digital inputs provides the lowest possible input path latency.

Before sample rate conversion is defeated on any input connected to a digital source, that source device must be synchronized (clocked) at 48 kHz in one of the following ways:

Using Word Clock Out from the Stage Rack

(Stage Rack with DSI Card)

◆ Connect the Word Clock Out provided on the DSI card to the corresponding digital device. Set the external device to slave to the incoming word clock signal.

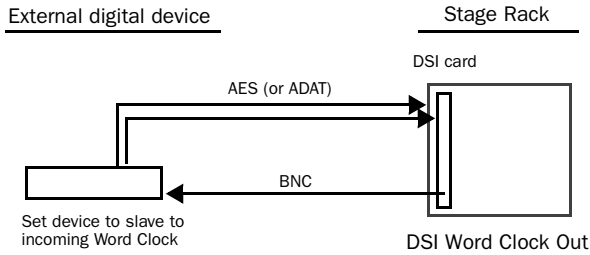

Using word clock from the DSI card to clock an external device

Using Word Clock Out from the FOH Rack

(Stage Rack with DSI Card)

◆ Connect the Word Clock Out on the FOH Rack to the corresponding digital device. Set the external device to slave to the incoming word clock signal.

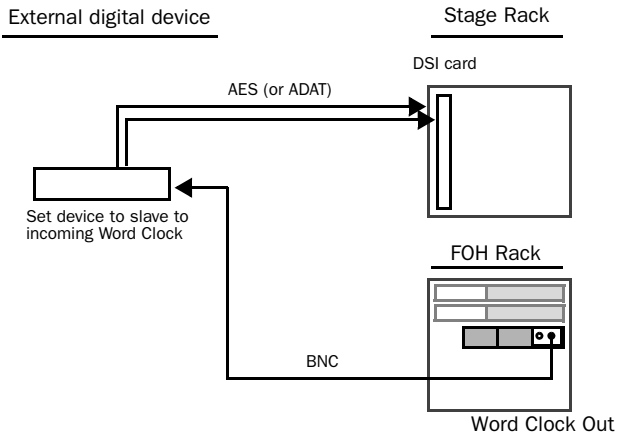

Using word clock from the FOH Rack to clock an external device

Using Digital Audio Outputs from the VENUE System

◆ Connect any digital output to a digital input of the external device: Use digital outputs on the Mix Rack (if the system also includes an XO16 card), Stage Rack (if the system also includes a DSO card) or any digital output on the FOH Rack. Set the external device to slave to its digital input.

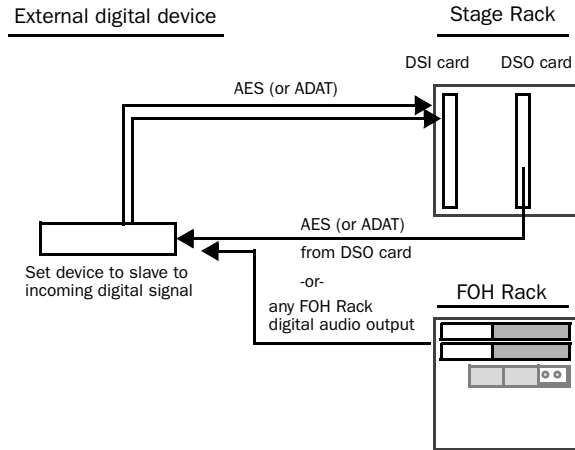

Using a digital output to provide clock to an external device

Using House Clock

◆ Connect a "house" or other external master clock signal to the Word Clock In on the FOH Rack. Distribute the same house clock to the external digital device, and set it to slave to the incoming house word clock signal.

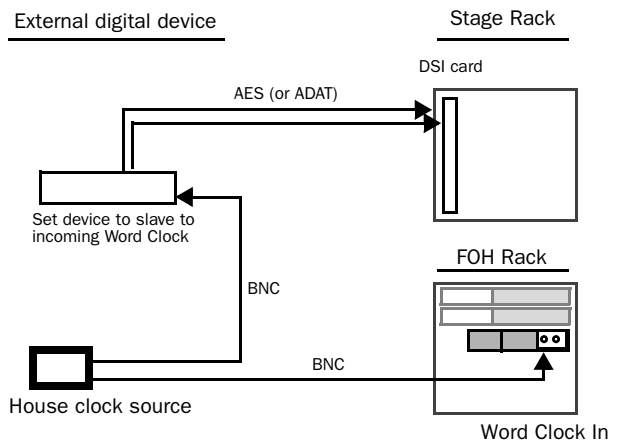

Using a distributed house (master) to clock a VENUE system and an external device

Part II: System Description

Chapter 3: VENUE D-Show Control Overview

D-Show Main Unit and Sidecar Top Panels

The following figure identifies the main sections of the D-Show console:

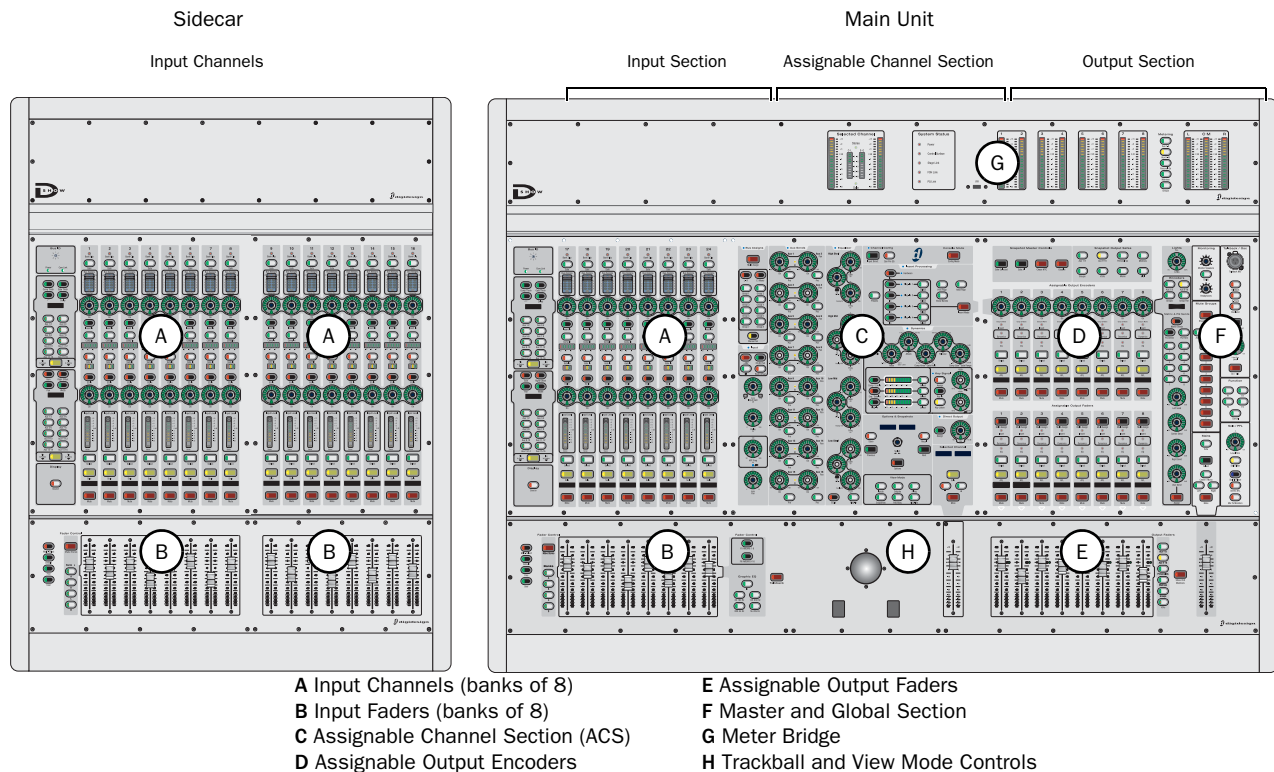

Figure 9. Control Surface main sections

The D-Show console consists of one Main Unit and one or more Sidecars.

Main Unit The Main Unit provides eight bankable input channel strips, the Assignable Channel Section (center section), eight Assignable Output Encoders, eight Assignable Output Faders, and one Mains Fader and Master Controls section.

Sidecars Each D-Show Sidecar provides 16 additional bankable input channel strips. Sidecars can be attached to the left of the Main Unit, attached to the right side, or kept free-standing (unattached) on either side.

Input Section

The Input Section provides Input Channels and FX Returns, with channel faders and two rows of assignable encoders.

Assignable Channel Section

The Assignable Channel Section provides expanded routing and processing controls for the currently targeted channel.

Output Section

The Output Section includes two sets of output controls that can be used to control two different sets of outputs at the same time:

- The Assignable Output Encoders adjust the assigned output or bus, or plug-in parameters (when in Insert mode), and are also where you set up Matrix and PQ sends.
- The Assignable Output Faders adjust the assigned output, bus, or VCA.

Input Channels and Faders

Inputs include Input Channels and FX Returns. Each input strip provides level faders, solo, mute, and Select switches, two rotary encoders, Bus Assign LEDs (routing indicators), as well as display LCDs and status LEDs.

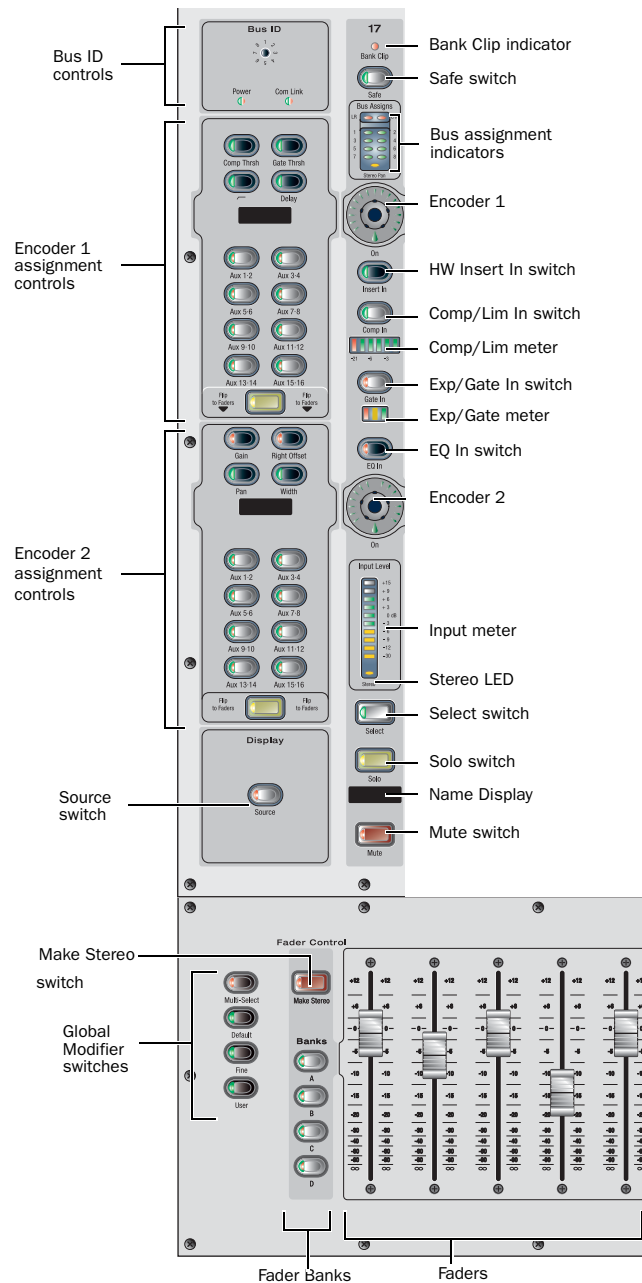

Input strip and fader controls

Bank Clip LED

The Bank Clip Indicator lights to indicate a meter clip on an input at the corresponding position in an alternate bank of channels. This indicator obeys the same clipping threshold display rules as the Input Channel meters (as set in the Options > Interaction page). It gives you an indication of extreme signal level in a currently hidden (“off-bank”) layer.

Safe LED

Automation Safe, Solo Safe, or Bank Safe

The Safe LED indicates either an input strip’s Automation safe status, Solo safe status, or Bank Safe status, depending on the current Input Safe Switch setting. See “Input Safe Switches” on page 58

Auto Safe Mode If the Safe LED is lit, the channel will not respond to Snapshot-driven changes. If the LED is off, that channel will respond to any applicable changes driven by Snapshots (subject to the current Recall Safe settings, if Recall Safe is enabled).

Solo Safe Mode If the Safe LED is flashing, the channel will not respond to solo commands (it will not be muted if another channel’s solo button is pressed). If the LED is off, that channel will be silenced when soloing another channel.

Bank Safe Mode If the Safe LED is flashing rapidly, the channel remains in place on the top fader layer when a different Bank (A–D) is selected (it will be unlinked from console banking). If the LED is off, the channel follows banking.

Pressing a channel Safe switch for the Selected Channel toggles the current state of that channel.

Bus Assignment Indicators

These green LEDs indicate Group bus assignments, and can also show VCA or Mute Group membership for each channel. By default, Group bus assignment is displayed.

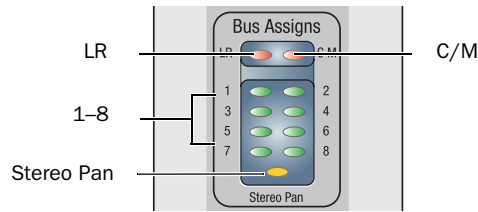

Bus Assign indicator LEDs on an Input Channel

Group Bus Assignment

- ◆ If the LR LED is lit, the input channel feeds the Left and Right Main busses in either L-R or L-C-R panning mode (regardless of the Stereo Pan LED status).
- ◆ If the C/M LED is lit, the input channel feeds the C (center) bus from the pan in L-C-R mode, or the M (mono) bus before the pan. Stereo channels are summed to the mono bus.
- ◆ If a bus LED (1-8) is lit, the channel is feeding the corresponding Group(s). If an LED is off, the channel is not feeding that Group. The Bus Indicators can also show VCA and Mute Group membership.

 Use the Bus Assign switches to route and assign the currently selected channels to busses.

VCA Membership

- ◆ When VCA Show Members mode is enabled, Group indicators flash to indicate VCA membership.

Mute Groups

- ◆ When the Mute Groups Show Members switch is pressed, the Group indicators flash to indicate Mute Group assignments. A flashing LED indicates that the channel is assigned to the corresponding Mute Group (1-8).

Stereo Pan LED This LED indicates when the channel is assigned to a stereo Groups bus.

Input Channel Meters

Each input channel provides meters for input, gain reduction, and input level, and LEDs for EQ, Gate, and stereo status.

Input Meter

The 10-segment input meter displays the level of the incoming input signal. A segment lights when the level of the incoming signal reaches or exceeds the segment's corresponding label. The entire meter lights red if the signal is clipping at any of the strip's multiple clip points. Normally, segments up to and including the segment labeled 0 dB display as green and the segments above 0 dB display as yellow.

 Because the lowest meter level is -30 dB, any input signal that is less than this value will not register on the input strip meter. The Selected Channel meter on the meter bridge and the on-screen meters register activity below -30 dB.

Stereo LED Below the input meter is a Stereo LED. This LED lights if the associated input strip is stereo. The LED flashes on/off anytime the strip is stereo and the difference in instantaneous peak level between left and right sides is 12 dB or more.

Comp/Lim Meter

The Compressor/Limiter meter has 6 LEDs to show the amount of gain reduction being applied to the signal by the built-in Compressor/Limiter. For more information, see Chapter 16, "Dynamics."

Expander/Gate Meter

The Expander/Gate meter has 3 LEDs to show the open/closed state of the built-in Gate, or the amount of gain reduction applied by the Expander. For more information, see Chapter 16, "Dynamics."

Input Encoders and Assignment Controls

Input Channels contain two separate banks of rotary encoders that can be assigned to control a variety of channel functions such as input gain, HPF corner frequency, pan/balance/width, and specific parameters of built-in Dynamics processes.

The Encoder Assignment switches, located to the left of each row of encoders, determine the function of the encoders on Input Channels. The LCD within each set of encoder controls displays the current function.

Rotary and Switch Functionality

Rotary encoders are dual-function controls that provide rotary and switch functions. In addition to adjusting parameters by turning the encoder, you can toggle parameters (such as taking the high-pass filter in or out of circuit) by pressing the encoder knob.

Encoder LEDs

Two types of LEDs surround each encoder:

- ◆ The LED ring around the encoder displays the relative position of its currently assigned parameter.
- ◆ Below each encoder is an indicator LED, which indicates parameter status (in/out) and various conditions related to the current encoder function.

Encoder 1 Assignment Switches and Functions

The Encoder 1 Assignment switches assign the following functions to Encoder 1 on each input channel strip:

Comp/Lim Thrsh Assigns the encoders to control the Threshold for the built-in Compressor/Limiter. Pressing the encoder toggles the effect in and out of circuit.

Exp/Gate Thrsh Assigns the encoders to control the Threshold for the built-in Expander/Gate. Pressing the encoder toggles the effect in and out of circuit.

HPF Assigns the encoders to control the HPF corner frequency. Pressing the encoder takes the built-in HPF in and out of circuit. If the LED is lit, the filter is in circuit.

Delay Assigns the encoders to control the amount of delay in the channel. Pressing the encoder takes the Delay in and out of circuit. If the LED is lit, the delay is in circuit.

AUX 1•2 TO AUX 15•16 Let you select one of two Aux sends in odd/even pairs.

- ◆ With mono sends, the first press of the switch selects the odd numbered send (1, 3, 5, or 7) and the second press selects the even numbered send (2, 4, 6, or 8). The switch lights green for the odd-numbered selection, or yellow for the even-numbered selection.

- ◆ With stereo-linked sends, the first press of the switch controls level for the bus pair, and the second press controls pan for the bus pair. The switch lights green for level control, or yellow for pan control.

Pressing Encoder 1 toggles the send on or off. When the send level is shown on the LED ring and the send is off, at most a single LED in the ring lights. When the send is on, all LEDs light in a clockwise order from the lower left to the send level.

When D-Show is in Variable Groups mode, the switches for Aux 1–2 through Aux 7–8 can be used to select Variable Group sends, and use the Encoder 1 to control the Variable Group send on/off, level, and pan parameters.

Aux Pan With stereo-linked Auxes or Variable Groups, the first press of this switch selects the level control for the Aux or Variable Group bus pair (green LED) and the second press selects the pan/balance control for the pair (yellow LED). When the Aux or Variable Group pair is following Main pan, the second press is not available.

Pan mode is indicated by the single-dot LED ring light pattern. Stereo-linked busses use a yellow color backlight in their name displays in the Outputs section to indicate stereo linking.

FLIP When enabled, the current encoder parameter is mapped to the channel faders. It can still be controlled from the encoder row, so the channel fader mirrors the setting. When Flip is engaged, all channel name display backlights turn yellow, the same color as the flip switch.

 *It is not possible to flip controls for both sets of encoders at once; the last-pushed Flip switch overrides previous Flip states.*

Display The 6-character display shows information about the currently selected function.

Table 4. Encoder 1 Displays

Switch	Display
Comp Thr	COMP
Gate Thr	GATE
	HPF
Delay	DELAY
Aux	AUX (number). Displays abbreviated name if Aux output is changed from default name
Aux (stereo)	APAN (number) Odd-numbered Auxes display pan information when Auxes are stereo-linked
Flip	Retains current selection

Encoder 2 Assignment Switches and Functions

The Encoder 2 Assignment switches assign the following functions to Encoder 2 on each input channel strip:

Pan/Bal Assigns the encoders to control channel Pan if the channel is mono, or stereo channel balance if a stereo. The indicator LED lights when the pan is at center.

Width (Stereo Channels Only) Assigns the encoders to control the ganged pan positions of Left channel and Right channel at the same time, but in opposite directions. Turning clockwise moves the pans towards full stereo, turning counter-clockwise moves the pans toward reverse-stereo. Since width is only applicable to stereo strips, this control is disabled when the associated input strip is mono.

Gain Assigns the encoders to control input gain according to the range available for this input. Pressing that holding the encoder initiates Gain Guess, in which D-Show automatically sets a nominal input gain level based on the incoming signal.

Right Offset (Stereo Channels Only) Assigns the encoders to control the gain offset of the right channel relative to the left. The offset ranges from -20 dB to $+20$ dB at the maximum but this range can be restricted depending on the current Gain setting.

AUX 1•2 to AUX 15•16 Same as in Encoder 1 Assignment panel (see “Encoder 1 Assignment Switches and Functions” on page 26).

Flip Same as Encoder 1 Assignment panel (see “Encoder 1 Assignment Switches and Functions” on page 26).



It is not possible to flip controls for both sets of encoders at once, and the last-pushed Flip switch overrides any previous Flip state.

Display The 6-character display shows information about the currently selected function.

Table 5. Encoder 2 Display

Switch	Display
Pan/Bal	PANBAL
Width	WIDTH
Gain	INP GN
Gain R	RGHTGN
Aux	AUX (number). Displays abbreviated name if Aux output is changed from default name
Flip	Retains current selection
Aux (stereo)	APAN (number) Odd-numbered Auxes display pan information when Auxes are stereo-linked

Insert In Switch

This switch toggles the hardware insert in and out of circuit (if assigned). If the switch is lit, the process is in circuit. Insert sends and returns are assigned in the Patchbay. On Inputs, the insert send is always sending. This switch does not affect inserted plug-ins. Plug-ins can be bypassed individually in the Assignable Channel Section.

Comp In Switch

This switch toggles the built-in Compressor/Limiter in and out of circuit. If the switch is lit, the process is in circuit.

Gate In Switch

This switch toggles the built-in Expander/Gate in and out of circuit. If the switch is lit, the process is in circuit.

EQ In Switch

This switch toggles the built-in EQ in and out of circuit. If the switch is lit, the process is in circuit.

Select Switch

The Select switch on each channel is used to target the channel in the Assignable Channel Section, and to include the channel in Multi-Select and Multi-Assign functions. A lit Select switch indicates the channel is selected. The name of the currently selected channel is displayed in red in the Channel Name display and in the ACS Selected Channel display. When multiple channels are selected, the red Channel Name display indicates which is channel is currently the ACS target.

Solo Switch

The Solo switch toggles the solo state of that channel. When enabled, the Solo switch LED is lit. When the channel is in Solo Safe mode, the Solo switch LED flashes. Channel Solo latches on a momentary press, and automatically releases if held for 2 seconds or more and released.

Mute Switch

The Mute switch mutes the channel at the (pre-fader) mute point. Channel pre-fader pickoff is post-mute.

Source Switch

The Source switch changes the Channel Name display to show the source input which is feeding each channel.

Name Display

This 6-character display shows the name of the channel, or Source if the Source switch is pressed. The name display for the currently selected channel is lit red. The channel name display can show other types of information according to the state of the Source switch or the current action.

Names This is the default display which shows the abbreviated channel names on all displays.

Values When a control is moved (or a fader is touched), the Channel Name display changes to Values display mode, where it shows each fader level or encoder function level as it is adjusted. You can turn off Values display switching so that the Name display does not show fader values (see “Displays” on page 59).

Source When this switch is pressed, the Name displays show the source input feeding each channel. Sources are abbreviated to indicate hardware input source and channel number. For example, if “S1A1” appears in a Channel Name display when Source is enabled, it indicates that the channel source is Stage Rack 1, Card A, Input 1.

Faders

Each channel fader is a 100mm motorized, touch-sensitive fader.

The Options > Interaction screen lets you enable touch-sensitive channel selection. When enabled, touching a channel fader automatically selects that channel and makes it the ACS target.

 *The faders on D-Show can be moved even when they do not sense a touch. This allows use of the faders while wearing gloves. It also lets you “throw” a fader and have it stay where it lands, and not snap back to the point it was last touched.*

Fader Banking Controls

Bank A–D The Bank A–D switches bank the Input strips, and let you link/unlink banking from each unit. By default, Bank width varies based on the number of Sidecars present. For example, on a system with one Sidecar, Bank A is channels 1–24, Bank B is channels 25–48, and so on. On systems with two Sidecars, Bank A is channels 1–40, Bank B is channels 41–80, and so on. The Options > Interaction screen lets you configure fader banking as global (all units in tandem) or split (local banking of faders, and encoders, on the main Unit and on each Sidecar). For more information, see “Main and Sidecar Split Banking” on page 39.

FX Returns The FX Return switches bank FX Return channels to the Input faders of the Main Unit.

Graphic EQ The Graphic EQ switches bank bands of graphic EQ to the faders. Graphic EQs can be used on D-Show outputs only. For more information, see Chapter 17, “EQ.”

Global Modifier Switches

To the left of the Bank A–D switches are the global modifier switches. See “Global Modifier Switches” on page 35.

Multi-Select Lets you select multiple input channels.

Default Lets you reset a parameter, section, or channel to default values.

Fine Lets you adjust rotary encoders with greater resolution for finer control.

User This switch is currently not implemented.

Make Stereo Switch

The Make Stereo switch lets you combine two mono channels into one stereo channel, or split a stereo channel into two mono channels. See “Combining Input Channels (Make Stereo)” on page 63.

Assignable Channel Section (ACS)

The Assignable Channel Section provides dedicated routing, EQ, Dynamics, and insert controls for the currently selected channel.

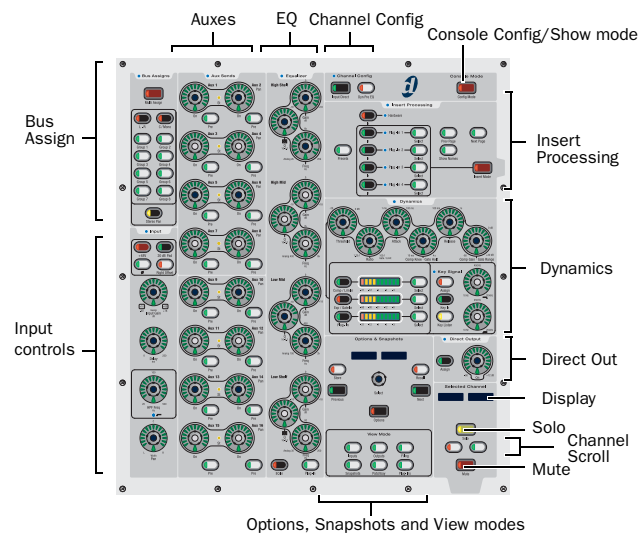

ACS main sections and controls

Input Controls

This section provides direct access to channel gain, HPF, delay, phantom power, and polarity (phase) for the currently selected channel.

Bus Assign

The Bus Assign switches are the primary routing controls for the currently selected channel, letting you bus it directly to the Main (L–R) bus or to any other mono or stereo group.

When D-Show is in Variable Groups mode, the Stereo Pan Switch in this section is used to display Variable Group parameters on the ACS Aux Sends controls.

Aux Sends

The Aux Sends section provides in/out and level control to route the currently selected channel to any available mono or stereo-linked Aux bus.

When D-Show is in Variable Groups mode, the controls for Aux 1–2 through Aux 7–8 can be used to route the currently selected channels to any available mono or stereo-linked Variable Group bus.

EQ

The EQ section provides dedicated controls for all built-in and compatible plug-in EQ parameters including band in/out, frequency, Q, and mode.

 *For more information, see Chapter 17, “EQ.”*

Channel Config

The Channel Config controls include the Input Direct and Dyn Pre EQ switches.

Input Direct Bypasses the built-in Dynamics and EQ processing, and all inserts on the currently targeted Input Channel or FX Return. The switch flashes to indicate Input Direct is active.

Dyn Pre EQ Enable Dyn Pre EQ to route audio on the currently targeted Input Channel to built-in Dynamics first, then to built-in EQ. The switch lights to indicate Dynamics precedes EQ in the signal path.

Config/Show Mode

This switch toggles D-Show between these two operational modes.

 *For more information, see Chapter 6, “Options.”*

Insert Processing

The Insert Processing section provides controls to bypass and adjust plug-ins on the currently selected channel, as well as to bypass hardware inserts.

Dynamics

The Dynamics section provides dedicated controls for built-in and plug-in dynamics processors, including a comprehensive set of Compressor/Limiter and Expander/Gate controls.

 *For more information, see Chapter 16, “Dynamics.”*

Direct Output

The Direct Output section provides level and in/out control for the channel direct output.

Solo and Mute

These switches provide channel Solo and Mute for the currently selected channel.

Channel Scroll

The Channel Scroll switches let you target other channels to bring them to the ACS (as an alternative to pressing channel Select switches). Press “+” to select the next channel. Press “–” to select the previous channel.

Options and Snapshots

The Options and Snapshots section, directly above the View Mode switches, provides access to the snapshots list.

Selected Channel Fader

The Selected Channel Fader is a 100mm, touch-sensitive fader that duplicates the fader for the selected channel.

Assignable Output Encoders

This section includes the eight Assignable Output Encoders and their corresponding function switches.

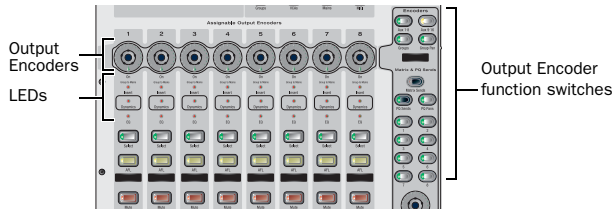

Assignable Output Encoder section

The switches to the right of the output encoders determine the function of the Output section Encoder row and its controls. When a function is selected, the Output Encoder section provides level control (using the encoders), solo, mute, and select switches for that output type.

Output Encoder Function Switches

Aux 1–8 Assigns the Output Encoder section to Auxes 1–8.

Aux 9–16 Assigns the Output Encoders section to Auxes 9–16.

Groups Assigns the Output Encoders section to Groups.

When D-Show is in Variable Groups mode, this switch assigns the Output Encoders section to control Variable Groups.

Group Pan Assigns the Output Encoders to (stereo) Group pan.

Display Shows the currently assigned function of the Output Encoder section.

Matrix and PQ Sends

The switches in the Matrix and PQ Sends section assign the Output Encoders to the following functions:

Matrix Sends Assigns the Output Encoders to control matrix input source levels and enables.

PQ Sends Assigns the Output Encoders to control PQ input source levels and enables.

PQ Pan Assigns the Output Encoders to control PQ input source panning.

Matrix/PQ 1–8 Assign the Output Encoders to show Matrix or PQ send levels and enable status, or Pan for selected Matrix or PQ send.

Left, Center, Right, and User Send Control the level of the Left, Center, Right, or User bus to the currently selected Matrix or PQ bus. Rotating the encoder adjusts the level; pushing the encoder toggles the send in/out.

Solo, Mute, and Select Provide solo, mute, and select for Auxes or Groups assigned to the Output Encoders.

Output Encoder and Fader Status LEDs

These multi-color LEDs indicate EQ, dynamics, plug-in, and insert status for the corresponding Assignable Output Encoders and Assignable Output Faders.

EQ LED

EQ LED color indications

Color	Meaning
Green	Output has a Graphic EQ and/or one or more EQ plug-ins assigned and in-circuit
Yellow	Output has a Graphic EQ and/or one or more EQ plug-ins, but none are in-circuit
Off	No Graphic EQ or EQ plug-ins are assigned on the current output

DYN LED

Dyn LED color indications

Color	Meaning
Green	Output has a Dynamics plug-in assigned and in-circuit
Yellow	Output has one or more Dynamics plug-ins, but none are in-circuit
Off	No Dynamics plug-ins are assigned on the current output

INSERT LED

Insert LED color indications

Color	Meaning
Green	Output has at least one of the following currently in-circuit: a hardware insert, and/or at least one non-EQ and non-Dynamics plug-in
Yellow	Output has at least one of the following but none are in-circuit: a hardware insert, or a non-EQ and non-Dynamics plug-in
Off	Output has no hardware insert or plug-in

Assignable Output Faders

The Assignable Output Faders control the currently selected Output type (Auxes, Groups, Matrix, PQ, or VCAs), chosen using the Output Faders switches.

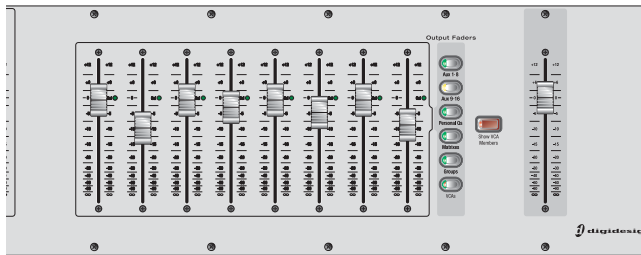

Output Faders switches

Output faders

Aux 1–8 Assigns the Output Faders to control Aux 1–8 levels.

Aux 9–16 Assigns the Output Faders to control Aux 9–16 levels.

Personal Q's Assigns the Output Faders to control PQ mixer output levels.

Matrixes Assigns the Output Faders to control Matrix mixer output levels.

Groups Assigns the Output Faders to control Group levels.

When D-Show is in Variable Groups mode, this switch assigns the Output Faders to control Variable Groups.

VCAs Assigns the Output Faders to control VCAs.

Master and Global Controls

The Master and Global section is located at the far right of the Main Unit. It includes the Monitoring, Mute Groups, Mains, Talkback/Com, Function, and Solo/PFL sections and controls.

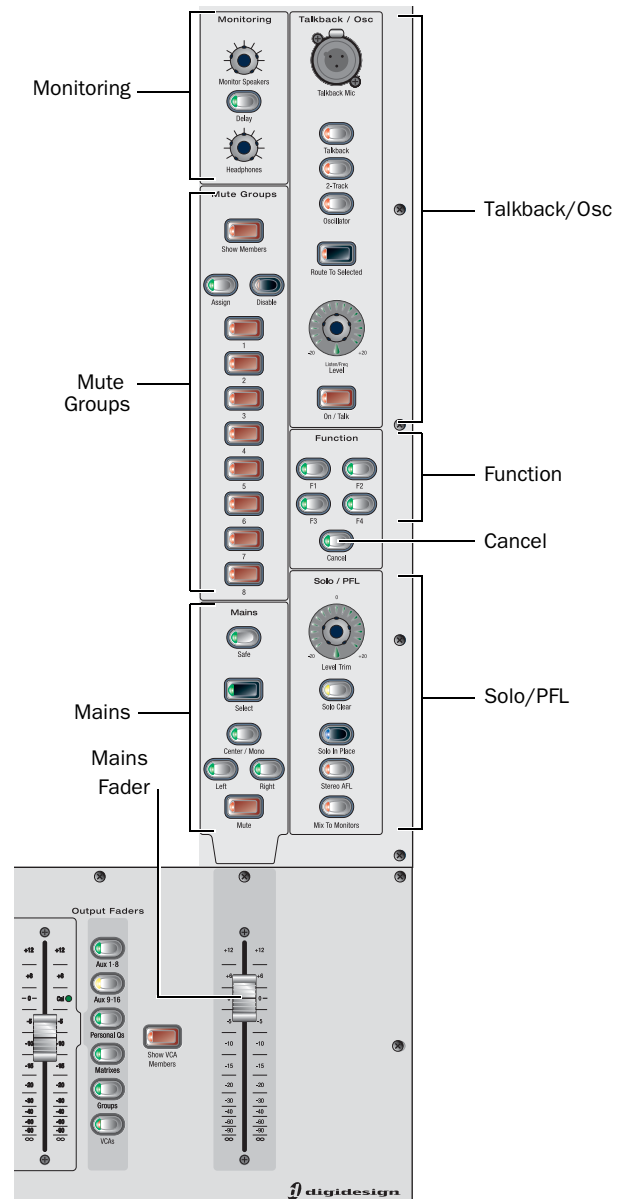

Master and Global controls

Monitoring

This section provides level and delay controls for near-field monitors and headphones. Separate level controls are provided for the monitor and headphone outputs. The Delay switch lets you set an amount of delay to be applied to both, to time-align their output at the front of house position.

Mute Groups

Mute Groups let you quickly mute multiple channels at the same time. You can create and recall up to eight Mute Groups comprising one or more channels.

Mains Controls and Fader

This fader and its function switches let you control the Main (or “house”) bus levels (L–R+M, or L–C–R).

The function switches directly above the Mains Fader let you select which Main output bus the Main Fader controls. This lets you assign the Mains Fader to all the Main busses (L–R+M, or L–C–R) simultaneously, or to individual Main busses to trim and balance Main bus output levels.

 On-screen, three discrete faders are provided for L, R, and C/M. By default, the on-screen L and R faders are linked for stereo level adjustment; drag the C/M fader to adjust its level. On the control surface, all three Mains channels are enabled at the Mains Fader (L, R, and C/M).

Talkback/Osc

The controls in this section provide comprehensive and flexible communication control, including a top-mounted Talkback input (XLR), Assign switches, and level control.

Function Switches

This section provides four Main Function switches (F1, F2, F3, and F4) and the Cancel switch. The Function switches are assigned to following actions by default; you can customize their function in the Event List:

- F1** Toggles snapshot Preview mode on or off.
- F2** When in Variable Groups mode, F2 toggles display of Variable Group controls in the Input Encoder rows and the ACS.
- F3** Copies the currently targeted channel settings to the clipboard.
- F4** Pastes the contents of the clipboard to the selected channel(s).
- Cancel** Cancels the current operation, such as Multi-Select or Multi-Assign modes.

Solo/PFL

This section provides control over the primary Solo features, including Solo Level and mode selection. Numerous options are provided to customize Solo operation in the Options screen.

 For more information, see Chapter 14, “Solo and Monitor Busses.”

Meter Bridge

The Meter bridge displays level for the currently chosen output type, as well as high-resolution Selected Channel meters for the currently selected channel.

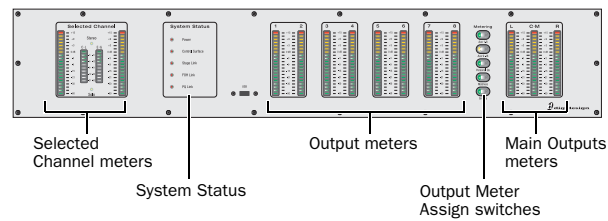

Meters, displays, and controls in the Meter bridge

Meters

The Meter bridge Output meters can be assigned to show Aux, Group, Mains, or other output levels. By default, output metering follows Output Fader assignment. You can also designate which output type to display in the Output meters.

 For more information, see Chapter 13, “Metering.”

System Status Panel

The System Status Panel provides LEDs that indicate the status of system communication. Use these LEDs to confirm connections and communication between components, and for troubleshooting.

When all components are communicating properly, the Status LEDs light green. If any Status LEDs are flashing, or red, it indicates possible problems with that component of the system.

 For more information, see Chapter 28, “Troubleshooting.”

Trackball and View Mode Controls

Trackball

The Trackball and its two switches are used to navigate on-screen.

View Modes

The View Mode switches (Inputs, Outputs, Filing, Snapshots, Patchbay, Plug-ins) display the corresponding pages on-screen. Pressing a View Mode switch repeatedly cycles through the individual tabs of that page. For example, pressing the Patchbay switch once displays the Patchbay screen. Pressing Patchbay again cycles through various tabs within the Patchbay page.

Chapter 4: Basic Commands and Modes

Control Overview

Most features and controls that are used during a performance are available from both the console and on-screen. Changes made on one are immediately reflected in the other, letting you use almost any combination of console and screen controls to mix.

The software screen is not required in order to mix a performance, as all essential mixing controls are provided on the console. However, the screen is essential when setting up and configuring the system before a performance.

Software-Only Controls and Displays

Many configuration settings and options are only available on-screen, including hardware configuration settings, busses, plug-in installation, and system diagnostics. For more information, see “System” on page 51.

Software Screen Banner Display

The software screen provides a banner display in the lower left corner. This display is provided to maintain line-of-sight mixing by showing the currently adjusted parameter (such as fader level or compression threshold) as you make changes to the parameter. The banner display also provides Tool Tip text and status messages.

Tool Tips

With the mouse or trackball, place the cursor over a screen item to see a brief explanation in the banner display.



Status bar showing Tool Tip

Status Messages

The banner display alerts you to certain operating conditions such as Multi-Select and Multi-Assign modes.



Banner display showing current state of the system

Console and Software Screen Linking

The software screen is linked to console actions by default. For example, selecting an input channel on the console changes the screen to the Inputs page, and selecting an output bus changes the screen to the Outputs page. You can customize how the system targets channels to best match your working style. For more information, see “Interaction” on page 58.

Config Mode and Show Mode

There are two main operating modes, Config Mode and Show Mode. Use Config mode to set up your system and options; use Show mode to mix your performance.

Config Mode

Config mode provides access to the configuration settings that are typically performed as part of system setup (before mixing). For example, you must be in Config mode to do any of the following:

- Choose a Main mix format (L-R+M, or L-C-R)
- Designate the number and mono/stereo format of available auxes and groups, combine two mono channels into one stereo input channel, or split a stereo input channel into two mono channels.
- Install plug-ins
- Assign plug-ins in the software racks
- Route side-chain inputs to plug-ins
- Initialize (or reset) hardware devices and options
- Change Matrix and PQ Source pickoff points
- Change Master Insert points
- Customize console and software interaction
- Move channels to different fader strips
- Perform system tests and diagnostics

▲ Some Config mode operations interrupt audio throughput.

Show Mode

Show mode is the main operating mode for the system software. All mixing and routing features are available, based on your settings made in Config mode.

Toggling Between Config Mode and Show Mode

To put the system into Config mode or Show mode, do one of the following:

- Press the Console Mode switch located at the upper right of the ACS). When the switch LED is lit, the system is in Config mode.
 - or –
- Double-click the Mode display in the Status Bar, located in lower-right hand corner of the screen.

System Lock

System Lock locks out all manual changes (console and screen actions), allowing the operator to safely step away from the system. Audio continues to pass but is not affected by console controls until the operator disables System Lock.

(System Lock is not available in the Standalone software.)



System Lock button on the Options > System page

Locking and Unlocking the System

To engage System Lock:

- 1 Go to the Option > Systems page.
- 2 Click the Lock button in the System section.
- 3 In the dialog that appears, click Lock.

On the console, the LCDs for each 8-channel fader bank display System Locked.

On-screen, an Unlock button appears in the lower right corner in front of a dimmed background image.

 You can add your own custom images to display in place of the default VENUE logo. See “Customizing the System Lock Display” on page 35 for information.

To unlock the system (disengage System Lock):

- Do either of the following:
 - Press and hold the Cancel button on the console for two seconds.
 - or –
 - Click Unlock in the lower right corner of the screen.

 The Unlock button is hidden after a few seconds. Touch the mouse or keyboard to bring it back.

System Status while Locked

GPI All console GPI inputs and outputs are disabled while the system is locked.

Footswitches All Footswitch inputs are disabled while the system is locked.

Events All Event triggers and actions that include console or GPI/Footswitch functions are disabled while the system is locked.

MIDI and MTC

While the system is locked:

- Snapshots continue to be recalled via MTC, either internally or externally generated.
- The system continues to respond to snapshot changes via incoming MIDI program change commands if the Snapshots Respond option is selected on the Options > Snapshots page.
- The system continues to send MIDI program changes when a snapshot is recalled if the Snapshots Send option is selected on the Options > Snapshots page.
- The system continues to send MIDI messages stored within snapshots, provided the MIDI data type is scoped.

 MTC can be disabled using the CHASE MTC button on the Snapshots page. Also, the sending and receiving of MIDI data can be turned off by deselecting the MIDI options on the Options > Snapshots page.

Customizing the System Lock Display

You can manually add one or more custom images to display during System Lock, rather than the default VENUE logo background.

Multiple images are displayed one after the other for 20 seconds in a random order. (Pressing the Spacebar advances to the next image immediately.)

To install custom System Lock images:

- 1 Copy a .bmp or .jpg image file to a USB key disk or CD-ROM. (For optimal results image resolution should be 1024 x 768; smaller or larger images can be used, but will be centered or scaled, respectively.)
- 2 Put the system into Config mode.
- 3 Go to the Options > System page.
- 4 Ctrl-click the Shutdown button.
- 5 Copy the image from your USB key disk to the following location on the system drive:
User Data\D-Show\Images
- 6 Double-click the Return to D-Show icon on the Desktop to restart VENUE D-Show software.

Global Modifier Switches

VENUE D-Show provides a set of global modifier switches: Multi-Select (Shift), Default (Alt), Fine (Ctrl) and User. These are located to the left of the input faders

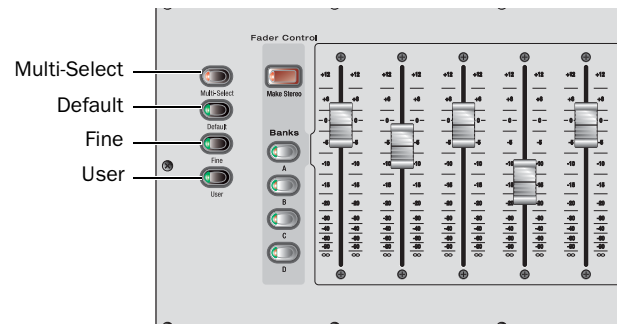

Global modifiers

These switches provide frequently used shortcuts that can be applied to console actions and software screen interactions.

Multi-Select Switch

The Multi-Select (Shift) switch lets you select multiple Input Channels and then apply an action to all selected channels. Multi-Select is useful for batch routing and assignment of input channels.

Most channel functions support Multi-Select (or Multi-Assign) as noted throughout this guide. For details, see “Selecting and Targeting Channels” on page 43.

Default Switch

The Default (Alt) switch provides a quick way to reset a control to its default setting (or “zero” the setting). It is equivalent to, and interchangeable with, the Alt key on the keyboard.

Examples of Using Default

To reset a fader to 0 dB:

- 1 Press and hold the Default switch.
- 2 Press the Select switch on the channel you want to reset.

To reset a single EQ parameter:

- Hold the Default switch and press the encoder or switch for that parameter.

 To reset a parameter using only the keyboard and trackball, Alt-click the on-screen control.

Fine Switch

The Fine (Ctrl) switch lets you adjust controls (except for faders) on the console or on-screen with maximum resolution. For example, if by default a control adjusts a parameter in units of 1 dB, the Fine switch allows adjustment in units of 0.1 dB.

To adjust a control with fine resolution:

- Press and hold the Fine switch while moving a control. The display associated with the adjusted control will show the values change at the corresponding resolution.

Momentary and Latching Modes

The Fine switch supports momentary and latching operation.

Momentary In momentary mode, the Fine switch stays in effect for as long as you hold down that modifier switch.

Latching In latching mode, the Fine switch stays in effect until you explicitly clear its active state.

To use the Fine switch in Momentary mode:

- 1 Press and hold the Fine switch.
- 2 Adjust a channel, parameter, or processor.
- 3 Release the Fine switch.

To use the Fine switch in latching mode:

- 1 Double-press the Fine switch. The switch LED lights.
- 2 Select or adjust one or more channels, parameters, or processors.
- 3 Press the Fine switch again to exit latching mode.

User

The User switch is reserved for future use.

Software Screen Pages and Tabs

Viewing Pages

To view a page, do one of the following:

- Press a View Mode switch.
 - or –
- Click the page name at the top of the screen.

When additional tabs are available for a page, go to those tabs by pressing the corresponding View Mode switch again to cycle through the tabs on that page, or by clicking their names on-screen.

Click page name to display



Viewing pages

Overview of Software Pages

The software screen provides the following pages and tabs.

Inputs

Select, name, configure, and adjust parameters for input channels and FX Returns.



Inputs page (analog input shown)

See Chapter 7, "Inputs and Input Routing."

Outputs

Select, name, configure, and adjust parameters for outputs.



Outputs page

See Chapter 8, "Outputs and Output Routing."

Filing

Load, save, and transfer shows and presets, and access the console History.

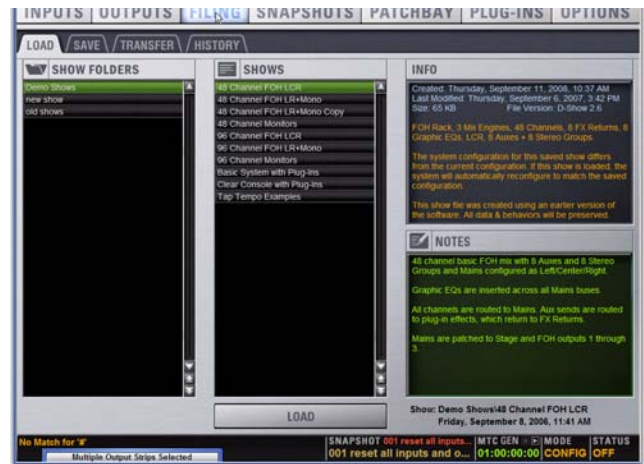

Filing (Load tab)

See Chapter 20, "Shows and File Management."

Snapshots

Store and recall snapshots, and access the Recall Safe window.



Snapshots page

See Chapter 21, "Snapshots."

Patchbay

Label your channels and assign input and output patching.



Patchbay (Outputs tab)

See Chapter 12, "Patchbay."

Plug-Ins

Configure and arrange plug-in racks by assigning plug-ins; patch/route and manage plug-ins.



Plug-In page

See Chapter 18, "Plug-Ins."

Options

Configure system, routing and metering options, set interaction, hardware and general preferences, install plug-ins, and access the Events window.



Options page (System tab for VENUE Mix Rack system shown)

See Chapter 6, "Options."

Chapter 5: Navigating and Selecting Channels

This chapter shows how to bank the different input and output sections of the console, how to select channels for routing and processing, and how to use screen controls and shortcuts for common channel operations.

Banking Input Channels and FX Returns

Many VENUE configurations utilize more physical inputs than input faders. To navigate to channels beyond the number of physical faders, the system provides channel *banking* controls.

The Bank switches navigate the display of input channels on the console.

- Input channel banks are accessed using the Bank A, B, C, and D switches, located to the left of the input faders.
- FX Returns are accessed using the FX Returns switches, located to the right of the eight input faders on the Main Unit.
- Input Channels and FX Returns can be put in Bank Safe mode, leaving them accessible regardless of the currently selected bank.

By default, input faders and encoders bank globally across all units. Optionally, you can set the console for split (or local) banking of faders and/or encoders.

Input Channel Banking

The Bank A, B, C and D switches affect all input faders.

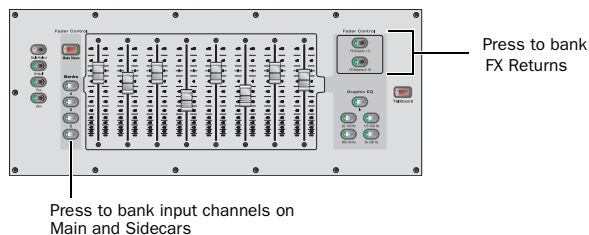

Bank switches for inputs

To bank Input Channels to the input faders:

- Press the appropriate Bank switch (A, B, C, or D).

To bank FX Returns to the Main Unit:

- Press a Fader Control switch (FX Returns 1–8, or FX Returns 9–16).

When you press the Bank switches (A, B, C, D) on any Sidecar (not the Main Unit), FX Returns will remain banked to the Main Unit input faders. This lets you have input and FX Returns available simultaneously.

 *Flip mode can be used to put Aux send level at Sidecar Input faders, leaving Main Unit input faders to control their FX Return level.*

To bank Input Channels while keeping FX Return channels on the Main Unit input faders:

- Press any of the Bank switches (A, B, C, D) on any Sidecar.

To return the Main Unit input faders to Input Channel banking, do one of the following:

- Press a lit FX Returns switch (1–8 or 9–16).
– or –
- Press any of the Bank switches (A, B, C, D) on the Main Unit.

Main and Sidecar Split Banking

You can link or unlink fader banking and/or encoder assignment across Main and Sidecar units.

◆ Unlinking Main and Sidecar banking lets you leave key channels available on one section of the control surface, while maintaining the ability to access other channels as needed within another section of the control surface.

◆ Unlinking encoder assignment lets you assign encoder functions locally, per Main or Sidecar unit.

Faders and encoders can be linked or unlinked as separate functions, giving you four possible configurations:

- Faders linked, encoders linked (the default setting)
- Faders unlinked, encoders linked
- Faders linked, encoders unlinked
- Faders unlinked, encoders unlinked

If more than one Sidecar is connected, each Sidecar functions independently (locally) when unlinked.

 *The Multi-Select, Default, Fine and Make Stereo switches remain linked between Main and Sidecar units regardless of Fader Bank or Encoder link status.*

 *The Aux Follows AFL switch toggles only the Main unit encoder assignments when units are unlinked (Sidecar encoder assignments are unaffected).*

Link status can be changed at any time (in both Config and Show modes) and settings are stored in the Show file.

To link or unlink fader banks from the console:

- Press and hold for two seconds any fader bank button on the Main unit or any Sidecar. All four Bank buttons and the Source button flash when link/unlink occurs. When linking, bank selection follows the unit the linking was initiated from

To link or unlink encoders from the console:

- Press and hold for two seconds any encoder assignment button on the Main unit or any Sidecar. All encoder assign buttons (except Flip) flash when you link or unlink.

 *The encoder Flip switch does not support control surface linking/unlinking. Use any other encoder assignment switch.*

To link or unlink fader banks and/or encoders on-screen:

- 1 Go to the Options page and click the Interactions tab.
- 2 In the Control Surface section, click to configure the options for Fader Banks and Encoders link status as desired.

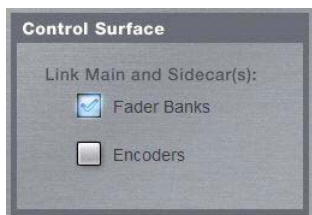

Options > Interaction page, Control Surface linking settings

Relinking

When you relink units from the Options > Interaction screen, all Sidecars conform to the current Main Unit input fader bank assignment. If the Main Unit is currently banked to GEQ or FX returns it automatically reverts to Input fader bank mode when units are relinked.

If you relink using the Fader Bank switches on the control surface, target and selection of other units follows the unit on which you perform the relink command (Main or Sidecar).

Bank Safe Mode

Bank Safe mode is a global Input Safe switch option available in the Option > Interaction page.

When Bank Safe mode is enabled, input channels and FX Returns can be Bank Safed using their Input Safe switches on the console, or on-screen. Bank Safed channels remain on the top fader layer of the console regardless of the current active bank, letting you temporarily “lock” the location of key input channels (such as a lead vocal, pulpit mics and similar) or FX returns to maintain immediate access while working with channels on a different layer.

For example, imagine 16 total input channels assigned to four banks (A through D) of an imaginary 4-fader console.

Default channel layout for a 4-fader example

Bank	Fader 1	Fader 2	Fader 3	Fader 4
A	Ch 1	Ch 2	Ch 3	Ch 4
B	Ch 5	Ch 6	Ch 7	Ch 8
C	Ch 9	Ch 10	Ch 11	Ch 12
D	Ch 13	Ch 14	Ch 15	Ch 16

Channel 6 on Bank B is then Bank Safed. Selecting the various banks gives the following results:

Channel layout with Bank Safe enabled on channel 6

Bank	Fader 1	Fader 2	Fader 3	Fader 4
A	Ch 1	Ch 6	Ch 3	Ch 4
B	Ch 5	Ch 6	Ch 7	Ch 8
C	Ch 9	Ch 6	Ch 11	Ch 12
D	Ch 13	Ch 6	Ch 15	Ch 16

Note that channels 2, 10, and 14 no longer appear on the console (though they remain accessible on-screen).

When an input channel or FX Return is removed from Bank Safe, the input channel that would normally appear in that fader location on the currently selected bank automatically re-appears.

Bank Safe is only available for Input channels (Output channels cannot be Bank Safed). Bank Safe status for all channels is stored with the Show file.

Enabling and Using Bank Safe Mode

Bank Safe mode can be enabled on-screen from the Options > Interaction page.

To enable Bank Safe mode on-screen:

- 1 Go to the Options > Interaction page.
- 2 In the Input Safe Switches section, click to enable Act as Bank Safes.



Choices for Input Safe Switches in the Options > Interaction page

On-screen, the Safe switches at the top of each fader display the letter B to indicate Bank Safe mode. (See “On-Screen Display of Safe Switch Status” on page 41.)

 You can also use the Event List to configure the Safe mode. For more information, see Chapter 22, “Events.”

Using Bank Safe

To Bank Safe channels:

- 1 Make sure you have enabled Bank Safe mode for the Input Safe switches.
- 2 Select one or more input channels.
- 3 To Bank Safe a single channel, press its Safe switch (at the top of the strip); to Bank Safe a selection of multiple channels, hold Multi-Select and press a channel Safe switch.

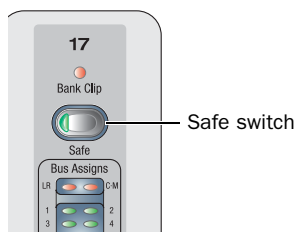

Selected Channel, Input Safe switch

- 4 Press a Bank switch (A, B, C or D) to navigate to a different bank. Notice that the channel you Bank Safed remains; corresponding channels on other banks, though not present on the console, are still accessible on-screen.

Toggling Bank Safe On-Screen

To Bank Safe channels on-screen:

- 1 Make sure you have enabled Bank Safe mode for the Input Safe switches.
- 2 Click the channel Safe buttons on-screen, located at the top of each input channel strip.



Toggling Bank Safe on-screen

Safe Switch LED and Indication

The Safe LED at the top of each input strip flashes rapidly to indicate Bank Safe is enabled on that channel.

When a Bank Safed channel is targeted, the Safe switch in the Input section also flashes rapidly.

On-Screen Display of Safe Switch Status

The channel Safe switches at the top of each strip of the on-screen faders light to indicate the current Safe status of each channel. When lit, that channel is enabled for the current Input Safe Switch mode (Automation, Solo, or Bank Safe). Each on-screen Safe switch indicates the current Input Safe Switch mode through use of a letter in the lit switch. For example, on-screen Safe switches show the letter B if Bank Safe mode is enabled and the channel is Bank Safed.



Bank Safe (two channels enabled)

Special Cases Affecting Bank Safe

Special rules and conditions are automatically applied to Bank Safe status whenever you do the following:

- Bank to GEQ faders
- Move channels or shuffle channel layout
- Change the system configuration

GEQ Fader Mode

Selecting a GEQ fader bank overrides Bank Safe. Returning to any fader bank (thus exiting GEQ Fader mode) restores the previous input layout, including Bank Safe status. This applies to channels 1–16 on VENUE Profile.

Moving or Shuffling Channels

Bank Safed channels shuffle accordingly when any operation is performed that results in a re-ordering of input channels, including the following:

- Inserting or Removing a Blank Strip
- Moving a strip
- Splitting a stereo strip(s)
- Opening a Show file that was saved on a VENUE system that used a different console.

Priority for Replacing Bank Safe Assignments

The following rules apply to resolve any potential collisions between Bank Safed channel assignments:

- Input channels always replace any FX Returns that are Bank Safed in that corresponding fader position.
- A lower numbered input channel always replaces a higher numbered input channel in that corresponding fader position.

In addition:

Make Stereo The Bank Safe status of the left channel is inherited by the newly created stereo channel.

Split Stereo The Bank Safe status of the stereo channel is applied to each of the newly created mono channels.

Bank Safe and Backup Personality

Channel Bank Safe remains in effect and available if Bank Safe mode is engaged. This ensures consistent and uninterrupted fader control during the rare case of a system reset.

Modified Bank Safe functionality is available while the Backup Personality is active. Specifically:

- Input Channel layout does not unexpectedly change when the backup personality is activated or de-activated.
- Input Channel Safe LEDs automatically revert to displaying Bank Safe status.
- The Safe switch in the Selected Channel Inputs section flashes rapidly if one or more channels are Bank Safed.
- Pressing the flashing Inputs Safe switch clears the Bank Safe status of *all safed channels*. Bank Safe status is not restored upon resuming normal operation, nor can it be re-enabled for any channel while the Backup Personality is active.

You cannot change the current Input Safe Switch mode while the Backup Personality is active.

After Resuming Normal Operation

Any changes to Bank Safe status made while the Backup Personality is active will persist when normal operation resumes. You can continue working uninterrupted knowing Bank Safe status will not be reset to its state prior to when the Backup Personality was activated.

Banking Graphic EQ Frequency Bands

When a built-in Graphic EQ is inserted on a currently targeted output or bus, its frequency bands can be banked to the eight input faders on the Main Unit.

 See Chapter 17, “EQ.”

Targeting Plug-In Inserts

Selecting a single channel targets that channel in the ACS. This lets you enable Inserts Mode to use the Output encoders to adjust plug-ins inserted on that channel.

 For more information, see See Chapter 18, “Plug-Ins.”

Banking the Output Faders and Output Encoders

Outputs are controlled using the Output faders and Encoders. These two sections can target independently, letting you view and control two banks of eight outputs simultaneously, as available in each control section, as follows:

Assignable Output Encoders These can target Auxes 1–8, Auxes 9–16, Groups (or Variable Groups), Matrix mixer inputs, or PQ mixer inputs.

Assignable Output Faders These can target Auxes 1–8, Auxes 9–16, Groups (or Variable Groups), Matrix mixer outputs, PQ mixer outputs, or VCAs.

To assign Aux, Group (or Variable Group), Matrix, or PQ controls to the Assignable Output Encoders:

- Press Encoder Assign switch, located to the right of the Output Encoder row.

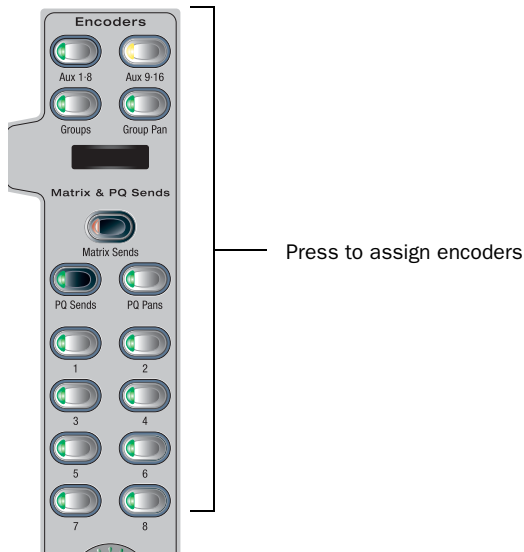

Assignable Output Encoder controls

To assign Aux, Group (or Variable Group), Matrix, PQ, or VCA controls to the Assignable Output Faders:

- Press the corresponding switch in the Output Faders section. Choices are Aux 1–8, Aux 9–16, Personal Q, Matrixes, Groups, and VCAs.

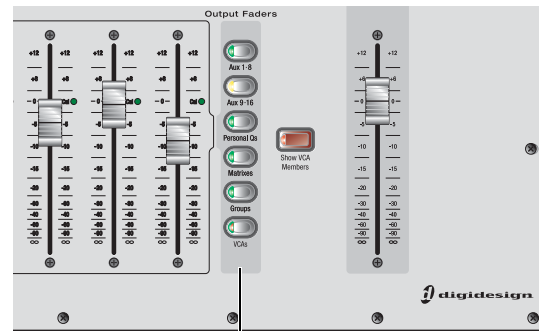

Press to bank Output faders

Bank switches for Outputs

Mains

The Mains fader provides constant access to the house output (Mains) bus, and does not follow Output fader banking.

Optionally, you can assign the Mains fader to control the Monitor bus (Cue) level. For more information, see “Cue on Mains Fader” on page 126.

Selecting and Targeting Channels

Each VENUE channel strip has a channel Select switch. The Select switch targets that channel for routing or processing assignment. When a single channel is selected it becomes the targeted channel, which can be adjusted from the console or on-screen. Channels can also be selected by clicking their fader strips on-screen.

To select a channel, do one of the following:

- Press the Select switch on the console channel strip.
- OR –
- Click anywhere in the on-screen channel fader strip, except on the fader, mute, solo or safe buttons.

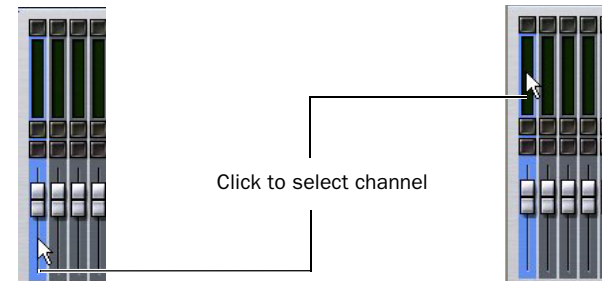

Clicking on-screen to select a channel

Multi-Select (Shift)

Multi-Select lets you select multiple channels in order to apply an action to them in one step.

To select multiple channels from the console:

- 1 Press and hold the Multi-Select switch (located next to the input Bank switches). The switch flashes to indicate Multi-Select mode.
- 2 Press Select on each channel you want to include in the selection.
- 3 Release the Multi-Select switch.
- 4 Perform a routing assignment or other function (for example, press a Bus Assign switch on one of the included channels). The operation is applied to all selected channels.

 You can use the Shift key on the keyboard or the Multi-Select (Shift) switch to select multiple channels.

To exit Multi-Select mode, do one of the following:

- Press Cancel.
 - or –
- Press the Select switch on a channel that is currently not selected.

To select multiple channels on-screen:

- Press and hold the Multi-Select switch (or hold Shift on the keyboard) and click the fader strips on-screen.

To select an 8-channel bank on-screen:

- Click the bank name below the on-screen fader strips. Shift-click to select additional banks or channels.

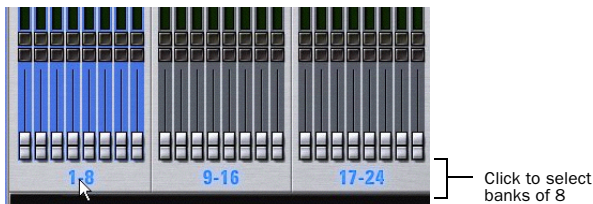

Clicking a bank display to select multiple channels on-screen

To select all input channels or all output channels on-screen:

- Double-click any bank name below the on-screen fader strips in the Input or Outputs screen.

To remove a channel from a selection:

- Control-click (or Fine-click) a highlighted channel.

 See “Screen Controls” on page 45 for additional on-screen features.

Multi-Assign

The Multi-Assign switch in the Output section is used to route multiple channels to the selected output bus.

To assign one or more channels to an Aux, Group, or VCA:

- 1 Press one of the following switches in the Output Fader assignment section:

- Aux 1–8
- Aux 9–16
- Groups
- VCAs

- 2 Press the Multi-Assign switch near the Output encoders. The flashing Multi-Assign switch and the banner display at the lower left of the screen indicate Multi-Assign mode is enabled.

- 3 Press the Select switches on the channels you want to assign to the Aux, Group, or VCA.

- 4 Select any other output to confirm the previous assignment and proceed to assigning channels to the new selection. To confirm the assignment and exit Multi-Assign mode, press the flashing Multi-Assign switch.

- 5 To cancel the assignment do either of the following:

- Press the Cancel switch (in the Mute Groups/Function section), or press the ESC key on your keyboard.

– or –

- Click Cancel in the on-screen Multi-Assign dialog box.

 See Chapter 8, “Outputs and Output Routing.”

Type Text Search

Type Text search lets you use the keyboard for fast navigation to a channel, or to quickly go to a specific snapshot or event. You can enter the first characters of a channel name or the absolute channel number to target that channel on the ACS. (See also “Selecting and Targeting Channels” on page 43.)

To search for and select a channel by name:

- 1 Go to the Inputs, Outputs, or Patchbay page.

- 2 Type the first few letters, channel number, or full name of the channel. For example, type “s” to go to the first channel beginning with the letter s (such as Snare).

- 3 Press the Tab key to cycle through and select any other channels beginning with that letter (such as *Snare Top*, *Snare Bottom*, or *Strings*).

To search for and select a list item by name (or number):

- 1 Go to the Snapshots, Events or Filing page. Or, click to open any Presets window (built-in Dynamics or EQ presets, Input Channel presets, or Scope Sets).
- 2 Type the first few letters or number of the desired item.
- 3 Press the Tab key to cycle through and select any other items that begin with the same letters.

Channel Numbers and Names

VENUE D-Show channel numbers are “absolute” channel numbers. Renaming changes the displayed name associated with each channel, but the absolute channel number remains fixed.

To search for and select a channel by absolute number:

- Type a number on the keyboard to select the corresponding channel.

 *Type Text search can also be used to select snapshots and events.*

Screen Controls

Adjusting On-Screen Faders

You can move on-screen faders independently or in ganged fashion.

To adjust a single fader on-screen, do one of the following:

- Drag a fader in the on-screen channel strip section at the bottom of the screen.
– or –
- Select a channel and move its fader in the on-screen selected channel controls.

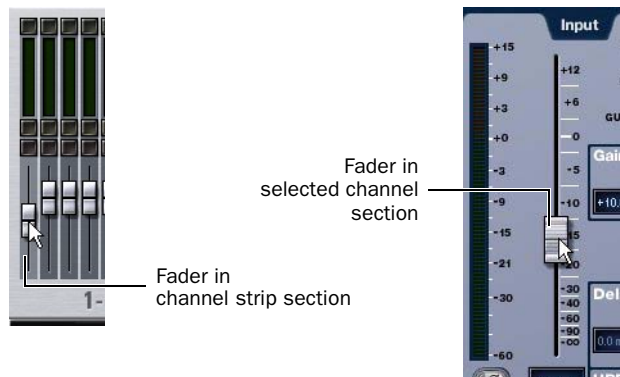

Dragging a fader on-screen

To move multiple faders on-screen in ganged fashion:

- 1 Select multiple channels on-screen by Shift-clicking.
- 2 Move the fader on one of the selected channels.

The faders on the selected channels will move in ganged fashion. Any offset between the faders is maintained until at least one of the faders is minimized (moved to -INF) or maximized (set to +12 dB).

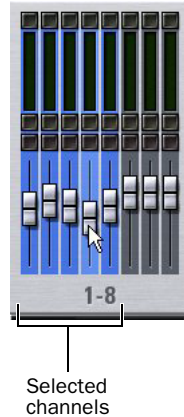

Dragging multiple faders on-screen

Adjusting On-Screen Encoders

You can adjust on-screen rotary encoders by dragging directly over the on-screen knob.

To adjust an on-screen rotary encoder:

- 1 Click on the knob so that it is highlighted.
- 2 Drag up to turn the encoder clockwise; drag down to turn the encoder counter-clockwise.



Dragging over an encoder on-screen

Adjusting Values On-Screen

In addition to typing numeric values in text boxes, you can adjust parameter values and numeric option settings on-screen by dragging directly over the corresponding text box.

To adjust a value on-screen by dragging:

- 1 Click in the text box to select the value.
- 2 Drag up to increase the value; drag down to decrease the value.



Adjusting a parameter value by dragging over its text box

Screen Shortcuts

The on-screen Fader display provides the following right-click shortcuts.



Right-clicking a fader on-screen (multiple faders selected)

See also “Fader and Encoder Shortcuts” on page 49.

Reset Fader to 0

Resets the fader position to zero.

Reset Selected Input Strips

Resets every parameter on the selected channel(s) to default settings.

Copy and Paste Channel

Channel settings can be copied in their entirety from one channel and pasted to one or more channels from the console or on-screen.

You can also store and load settings as Input Channel Presets. For information, see “Input Channel Presets” on page 49.

By default, Function switches 3 and 4 (F3 and F4) are programmed for Copy and Paste, respectively.

Using the Events List, Copy and Paste can be assigned to any trigger. For more information, see Chapter 22, “Events.”

To copy and paste channel settings from the console:

- 1 Press the Select switch on the channel you want to copy.
- 2 Press F3 to copy.
- 3 Press the Select switch on one or more destination channels (the channel or channels to which you want to paste the copied settings).
- 4 Press F4 to paste. The status displays shows a message confirming the Paste operation.

To copy and paste channel settings on-screen:

- 1 Do one of the following:
 - Right-click on a channel fader in the fader display across the lower half of the screen and choose Copy.
 - or –
 - Right-click within the upper channel display and choose Copy.



Copying channel settings

You do not need to select the channel before copying its settings on-screen.

- 2 Select one or more destination channels. You can only paste to selected channels.
- 3 Right-click on the lower fader strip on-screen, or on any non-control area of the destination channel, and choose Paste to Selected Strip(s). The status displays shows a message confirming the Paste operation.

Parameters and Channel Types

Input channels can only be copied or pasted to other Input channels. Output channels can only be copied or pasted to other channels of the same type (such as Aux, Group, PQ, Matrix). When pasting channel settings:

- Settings common to the source and destination channel are always pasted.
- Copied settings with no corresponding parameter in the destination channel are ignored.
- Settings in the destination channel with no corresponding parameters are left unchanged.

Copying and Pasting Mono and Stereo Channel Settings

You can copy a mono channel and paste its settings to one or more stereo channels. Mono settings are applied equally to the left and right channels of the stereo destination. The stereo destination channel retains its current balance and width settings.

You can also copy a stereo channel and paste its settings to one or more mono channels. The left channel settings of the stereo source are applied to the mono channel(s). The mono destination channel retains its current pan setting.

Settings Excluded from Copy and Paste

Input Channels The following Input channel parameters are not copied or pasted (the current settings of the destination channels are retained):

- Patchbay assignments, including Direct Outs
- Channel Name
- Hardware and software insert (plug-ins) assignments and in/out state.

Output Channels The following Output channel parameters are not copied or pasted (the current settings of the destination channels are retained):

- Patchbay assignments, including Direct Outs
- Channel Name
- Hardware and software insert (plug-in) assignments and in/out status
- GEQ settings
- Output membership (the assignment of channels to an Aux, Group, VCA, Matrix or PQ).



To copy GEQ settings, use the copy/paste GEQ shortcut or use GEQ Presets. Use the Replace with Mix (members) From command to replace output membership for an Aux, Group, VCA, Matrix or PQ.

Make Selected Mono Strips Stereo/Make Selected Stereo Strip Mono

Combines two selected mono channels into a single stereo channel, or splits a selected stereo channel into two mono channels. VENUE must be in Config mode to change the stereo status of a channel.

Move Selected Strip

Moves a selected strip from its current position to a new location. When you move a channel strip, other channels are moved (and renumbered) lower or higher to accommodate the moved channel.

VENUE must be in Config mode to move channel strips.

To move a fader strip:

- 1 Put the system in Config mode.
- 2 Select the channel you want to move.
- 3 On-screen, right-click on the destination strip (where you want to move the selected channel).
- 4 Choose Move Selected Strip Here from the pop-up menu.



Snapshots cannot store and recall custom console channel position.

Insert Blank Strip

The Insert Blank Strip command lets you insert one or more blank (or “spacer”) strips anywhere among your input channels. In addition, blank strips are automatically inserted when you use the Make Stereo command to convert two mono input channels into a single stereo channel, preserving the channel layout.

Blank strips are strictly placeholders (no audio or any type or processing take place), and therefore consume no additional processing overhead or DSP resources.

Use blank strips to create obvious divisions between groups of instruments, or to optimize the bank placement of inputs on the console.

Blank strips are saved and loaded as part of the Show file. Blank strips remain available during Backup Personality mode.

Blank Strips on the Console

A blank strip has no LCD channel name display, and all of its physical controls and indicators are inactive. Blank strip faders are set to the bottom (–inf) position and always revert to this position if moved.

Blank Strips On-Screen

Blank strips appear as a simple gray strip with no fader, buttons or meter. A blank strip can be right-clicked to reveal its context menu.

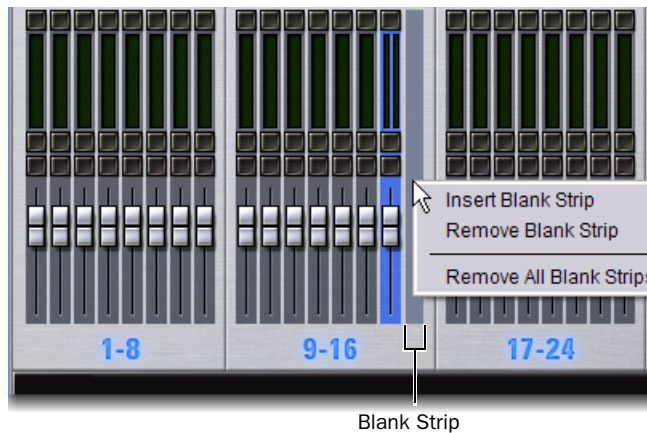

Blank strip in position 16, Right-click menu shown

Adding Blank Strips

Blank strips can be inserted manually, and are also created automatically when you use the Make Stereo command.

Manually Inserting Blank Strips

To manually add a blank strip:

- 1 Enable Config mode.
- 2 Right-click an input channel strip at the location where you want to insert a blank strip and choose Insert Blank Strip. For example, if you want to have a blank strip at channel strip 16, right-click on channel 16.

You can also select a blank strip and choose Insert Blank Strip to insert multiple blank strips.

All channels to the right of the insertion point (including the right-clicked channel) are shuffled one position to the right.

 This command will be unavailable if the combined number of input channel strips plus blank strips equals or exceeds 96. For more information, see “Limits and Guidelines for Blank Strips” on page 49.

To insert multiple blank strips:

- 1 Put the system into Config mode.
- 2 Create a multi-selection of channels.
- 3 Right-click on one of the selected channels and choose Insert Blank Strips at Selection.

A blank strip is inserted in place of each selected channel strip, shifting all channels accordingly and maintaining the multi-selection.

Automatically Inserting Blank Strips using Make Stereo

VENUE automatically creates blank strips when you use the Make Stereo command in order to preserve the current channel layout. Similarly, blank strips may be automatically removed when you use the Split Stereo command to revert a stereo strip to its two contributing mono channels.

Make Stereo A blank strip is automatically inserted at the location previously occupied by the right-side channel of the newly-formed stereo pair. There is no shuffling of the remaining input channels as a result of this operation.

Split Stereo The behavior when splitting a stereo strip into two mono strips is as follows:

- If a blank strip is located immediately adjacent to the (previously) stereo channel, the right channel of the stereo pair occupies this position and the blank strip is automatically removed. No other channels shuffle.
- If no blank strip is located immediately adjacent to the (previously) stereo channel, all channels to the right of the split point shuffle one position to the right and the right channel of the stereo pair is inserted.

Removing Blank Strips

Blank strips can be removed manually.

Manually Removing Blank Strips

To remove a blank strip:

- Right-click the blank strip you wish to remove and choose Remove Blank Strip.

To remove all blank strips:

- Right-click any blank strip and choose Remove All Blank Strips.

Blank strips are removed and all channels to the right are shuffled one position to the left.

Limits and Guidelines for Blank Strips

The maximum number of fader strips is 96. These 96 positions can be comprised of any combination of mono or stereo input channels, as well as blank strips. (FX Returns are considered separate and are not included in this count.)

The maximum number of blank strips that can be used varies depending on the current system configuration and the number of stereo channels used in the configuration. This number can be calculated as:

(96 – the number of input channels in System Configuration)
+ Number of stereo channels

For example:

- A 96 channel configuration with 96 mono channels can have 0 blank strips.
- A 48 channel configuration with 48 mono channels can have 48 blank strips
- A 48 channel configuration with 4 stereo channels can have 52 blank strips ($52 = 96 - 48 + 4$)

Fader and Encoder Shortcuts

The on-screen channel faders and encoders provide the following right-click shortcuts to reset individual parameters and channel strips.



Right-clicking channel strip controls on-screen

Reset Parameter

To reset an on-screen fader or encoder to its default value, do one of the following:

- Right-click the control and choose Reset.
– or –
- Alt-click the control.

Reset Channel

To reset an entire channel strip to its default settings:

- Right-click the on-screen channel fader and choose Reset Strip.

Input Channel Presets

Input channel configuration (input name, gain, fader levels, send levels and bus routing) can be stored and recalled as Input Channel Presets. Input Channel Presets can be previewed, recalled and transferred just like other VENUE preset files, letting you quickly configure channels from among a library of favorite setups.

When an Input Channel is stored or recalled as a preset, all parameters are affected except the following:

- Patchbay assignments, including Direct Outs
- Hardware and software insert (plug-in) assignments and in/out state.

⚠ Selecting a channel preset automatically loads the saved settings into the selected channel. Depending on the stored settings this may dramatically change channel level and signal routing. Use caution when previewing Input Channel Presets with a live source.

To store a channel as an Input Channel Preset:

- 1 Configure an Input Channel as desired.
- 2 Click the Channel Presets icon (the folder icon located to the right of the Channel Routing indicator and +/- buttons).

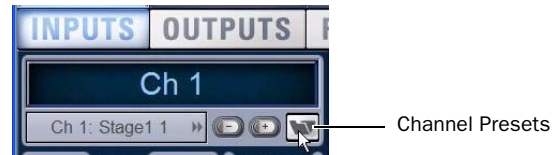

Channel Presets icon in the Inputs page

- 3 Specify a folder in which to save the preset, if the currently selected folder is not appropriate, by clicking the Folder selector and selecting a different folder.

- 4 Click New.

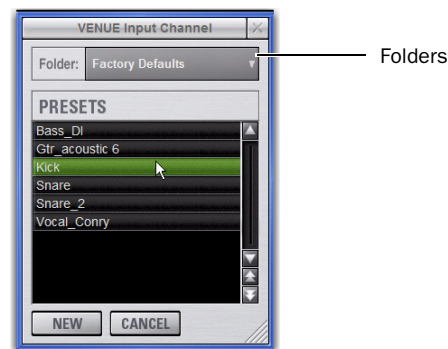

Input Channel Presets window

To preview and recall a saved Channel Preset:

- 1 Navigate to the Inputs page for the desired channel. Channel Presets can only be loaded into a single channel at a time.
- 2 Click the Channel Presets icon.
- 3 If necessary, click the Folders icon and select the appropriate Channel Presets folder from the pop-up menu.
- 4 Do any of the following:
 - To preview an existing Channel Preset, click its name in the Channel Presets window.
 - To load the currently selected Channel Preset, press Enter or click the Close box (X) in the Channel Presets window title bar.
 - To cancel without changing settings, click Cancel.

To rename, duplicate, overwrite or delete a Channel Preset:

- Right-click the preset name in the Channel Preset window and choose Rename, Duplicate, Delete, or Overwrite.

Channel Compatibility and Input Channel Presets

The following describe how different types of channel data is handled when storing or loading Input Channel Presets.

Channel Names and Presets

New presets automatically inherit the current Input Channel Name, or you can give them a custom name in the Presets window. The default channel number (such as "Ch 16") is used for the preset name if the channel has an empty (null) name.

Loading Mono and Stereo Channel Presets

You can load mono Channel Presets into stereo channels, and stereo Channel Presets into mono channels.

Loading Mono to Stereo Mono settings are applied equally to the left and right channels of the stereo destination. The stereo destination channel retains its current balance and width settings.

Loading Stereo to Mono When loading a stereo preset into a mono Input Channel, the left channel settings in the stereo preset are applied to the mono destination channel. The mono destination channel retains its current pan setting.

Channel Compatibility

When storing and loading Input Channel presets, remember the following:

- ◆ Group bus assignments are not applied if the settings in the preset do not match the current console Bus Configuration
- ◆ Aux send level or pan settings for individual aux pairs are not applied if the stored stereo link/unlink state does not match the current link/unlink state. For example, assume the stored preset has Aux 1–2 linked, but the current console configuration has these Auxes unlinked. When the preset is recalled Aux 1 and Aux 2 will retain their current settings (they will not be updated), while all other Auxes are updated to the preset settings.

Transferring Input Channel Presets

Input Channel Presets are available as Built-In Presets in the Transfer tab of the Filing page. This lets you transfer your Channel Presets to a USB key disk or other storage device for backup and transfer to other systems.

Input Channel Presets are supported on all systems running VENUE D-Show software 2.5 or later, including the Stand-alone software.

 For more information, see Chapter 20, "Shows and File Management."

Chapter 6: Options

The Options page provides several tabs. Of these, the System and Devices tabs are where most system configuration settings and options are enabled and customized:

- The System screen provides the primary tools by which you configure mixing, routing, and processing options.
- The Devices screen provides status, diagnostics, and options for hardware components.

This chapter shows you how to manage the most important System and Devices settings, and describes the settings available in other Options screens.

Overview of Options

The Options page provides the following tabs:

- “System” on page 51
- “Busses” on page 53
- “Pickoffs” on page 55
- “Snapshots” on page 55
- “Misc” on page 56
- “Interaction” on page 58
- “Devices” on page 53
- Chapter 22, “Events”
- Plug-Ins (see “Installing and Authorizing Plug-Ins” on page 151)

To display the Options page, do one of the following:

- Press the Options switch in the View Mode section.
– or –
- Click the Options tab on-screen.

To display different tabs of the Options page, do one of the following:

- Press the Options switch repeatedly to cycle through available tabs.
– or –

Click the desired tab at the top of the Options page (System, Busses, Pickoffs, Snapshots, Misc, Interaction, Devices, Events or Plug-Ins).

 *The Plug-Ins tab is not available in the Standalone software.*

System

(System Configuration)

The System page lets you allocate DSP resources used for routing and processing, configure Mains and Aux/Group busses, reset the system (clear console), and quit (shut down VENUE).

To access the System Config page:

- Go to the Options page and click the System tab.

Basics of Editing System Settings

Settings available in the System screen can only be edited while in Config mode.

 *Changing the system configuration will restart the system software and may interrupt audio.*

In Config mode, the Edit button becomes available to let you change settings. When a System Config setting is changed, the Apply button becomes available at the right of the screen to let you confirm and apply changes.



System Configuration tab of the Options page

In Show mode, the Edit button is unavailable. This protects these settings from being changed during a performance (since changes to these settings can interrupt audio).

To change a System Config option:

- 1 Put the system in Config mode.
- 2 Go to the Options page and click the System tab.
- 3 Click Edit.
- 4 Change a System Config, Main Bus, Inputs or Bus Configuration option.
- 5 Click Apply to confirm and apply your new settings.

System Configuration Settings

The System Configuration section shows the current allocation of system resources.

In Show mode, the System Config area is display-only. In Config mode, you can edit the system configuration to allocate resources for mixing and processing.

To change a System Configuration setting:

- 1 Put the system in Config mode.
- 2 Click the Edit button on-screen.
- 3 Choose a new setting for Input Channels or Graphic EQs.
- 4 Click Apply to confirm the settings.

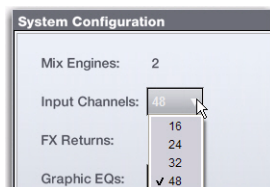

Designating the number of Input Channels

Mix Engines

The Mix Engine setting is determined by the number of DSP Engine Cards detected in the FOH Rack (or Mix Rack). FOH Rack comes with three Mix Engine cards and can be expanded up to five Mix Engine cards. Each Mix Rack comes with two Mix Engine cards, and can be expanded up to three.

Channels

Choose the total number of Input Channels you need. This number represents mono channels; each stereo channel uses two mono channels.

- You can configure a VENUE D-Show system (FOH Rack and one or more Stage Racks) to use 16, 24, 32, 48, 64, 80, or 96 input processing channels (higher settings require two Stage Racks).
- Systems that use a VENUE Mix Rack system can use 16, 24, 32, 48, or 64 input processing channels.

Choosing a lower number of Input Channels leaves more DSP for plug-ins; choosing a higher number reduces the amount of DSP available for plug-ins.

FX Returns

Choose the number of FX Return channels you need (8 or 16).

Graphic EQs

Choose the number of Graphic EQs needed for output processing. You can choose to have 0, 8, 16, or 24 Graphic EQs. Choosing a lower number leaves more DSP for plug-ins.

DSPs Available for Plug-Ins

The amount of DSP available for plug-ins depends on the number of Mix Engine cards installed in your FOH Rack or Mix Rack, and the current system settings for Input Channels, FX Returns, and GEQs. To increase the amount of DSP available for plug-ins, reduce the number of Input Channels or Graphic EQs, or add additional Mix Engine cards.

Main Bus Settings

The Main Bus Settings let you configure the Main mix bus. See “Configuring Aux, Group, and Variable Group Busses” on page 76.



Main Busses options in the System page

L-R plus Mono

This default setting provides a stereo bus, plus one mono bus.

L-C-R

This setting enables L-C-R mode, which lets you mix in “3-across-the-front” mode.

⚠ Changing the Main Bus mode will restart the system software and may interrupt audio.

To change the Main Bus configuration:

- 1 Put the system in Config mode.
- 2 Go to the Options page and click the System tab.
- 3 Click Edit.
- 4 Click to choose a Main Bus mode.
- 5 Click Apply; the system restarts.

Bus Configuration Settings

The Bus Configuration Settings let you choose the Aux and Group/Var Group busses configuration. See “Configuring Aux, Group, and Variable Group Busses” on page 76.



Bus configuration settings in the System page

To change the Aux/Group Bus Configuration:

- 1 Put the system in Config mode.
- 2 Click the Edit button on-screen.
- 3 Click to select a Bus Configuration option.
- 4 Click Apply; the system restarts.

Devices

The Devices page lets you view system connections, troubleshoot hardware and reset VENUE system components.

To display the Devices tab:

- Click Options > Devices.

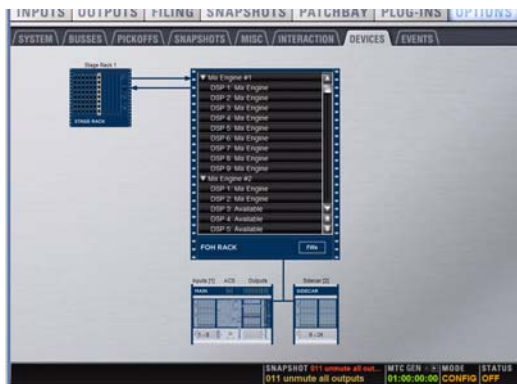

Devices tab of the Options page

You can use this page to view component status after diagnostics or troubleshooting.

To reset VENUE system hardware components:

- 1 Put the system in Config mode.
- 2 Go to the Options page and click the Devices tab.
- 3 Right-click any of the following hardware components:
 - Console sections
 - Racks (FOH Rack and Stage Rack, or Mix Rack)
- 4 Choose Reset.

Simulating a VENUE Configuration with the Standalone Software

With the VENUE D-Show Standalone software, you can use the Devices page to simulate a VENUE system of any size for purposes of preparing shows and training. See “Simulating a VENUE Configuration” on page 224.

Other Options and Settings

Busses

The Busses page lets you customize characteristics for the Aux, Solo, Matrix, and Main busses.



Busses tab of the Options page

Auxiliaries and Variable Groups

These options let you designate bus link status, pick off source, and stereo pan behavior for Auxiliaries (Aux Send busses).

Links When enabled, this option links the corresponding busses into bus pairs. Control changes affect both mono Aux busses, and the Follows Channel Pan option becomes available.

Pickoff These options let you designate the pre-fader pickoff point feeding each bus. Choices include pre-EQ, pre-mute, and pre-fader (post-mute).

Follows Channel Pan Each channel can be panned independently within each linked bus pair, or configured to follow the channel pan by enabling the Follows Channel Pan option.

To change the Aux bus configuration:

- 1 Put the system in Config mode.
- 2 Go to the Options page and click the Busses tab.
- 3 Click Edit.

4 Configure the following settings:

- To link two mono Aux busses into a bus pair, select the Link option for the corresponding pair.
- Specify the panning for channels routed to Aux bus pairs with the Follows Channel Pan option.
- Click to select the pickoff point for each bus (Pre-EQ, Pre-Mute, or Pre-Fader).

5 Click Apply to reconfigure the system, or click Cancel to exit without changing system settings.

 For more information, see Chapter 10, “Aux Sends and Variable Groups.”

Solo and Monitor Operations

These settings customize Solo and Monitor (cue) bus mode and operation.



Solo controls in the Options > Busses page

Type Solo mode choices include PFL (Pre-Fader Listen), Stereo AFL (After-Fader Listen), and Solo-In-Place.

Level Trim Mirrors the functionality of the Solo/PFL level control on the control surface.

Monitoring Sets the level of the Headphone and Monitor outputs.

Delay Sets a delay for time-aligning headphones and near-field monitors to the house system.

Auxes/Var Groups Follow AFL Puts the controls for an Aux Send or Variable Group Send on the input channel encoders whenever the AFL switch is pressed on that Aux or Var Group bus.

AFL Follows Auxes/Var Groups Soloes the Aux (or Variable Group) bus that is currently assigned to input encoders.

Auto Cancel Soloing a channel strip automatically takes any currently soloed channels out of solo.

Input Priority Makes soloed inputs temporarily replace soloed output busses on the AFL/PFL bus.

Mix to Monitors Mirrors the functionality of the Mix to Monitors switch on the control surface.

Cue on Mains Fader Puts control of the Monitor bus level to the Mains fader.

To configure Solo settings on-screen:

- 1 Go to the Options page and click the Busses tab.
- 2 Configure settings as needed:

To adjust Monitor Bus Delay, do one of the following:

- Adjust the Delay encoder on-screen.
- Click the Delay value shown on-screen, and manually enter a new value.

To toggle Delay on or off:

- Click to toggle the Delay In switch on-screen.

 Delay settings are retained when toggled off or on.

 For more information, see “Solo and Monitor Busses” on page 121

Matrixes

The Matrixes section lets you link and unlink Matrix to form stereo Matrix busses.

Links When enabled, these options link corresponding mono Matrix busses into stereo-linked pairs. Control changes then affect both mono Matrix busses.

 For more information on these features see Chapter 11, “Matrix and Personal Q Mixers.”

Panning/Center Divergence

The Panning section provides control over center channel divergence when the Main Bus is set to L-C-R mode. See “Main Bus Center Divergence Options” on page 82.

To set Center Divergence:

- Enter a value or drag in the Center Divergence text box and press Enter.

Stereo Group Panning Operation

The Stereo Group Panning Operation options provide different levels of flexibility for how channels can be routed to Groups.

To change Stereo Group Panning Operation:

- 1 Put the system in Config mode.
- 2 Click to select Simple or Expert mode.

 For more information on these options, see “Simple and Expert Operational Modes” on page 91.

Pickoffs

The Pickoffs page lets you control the bus pickoff point on input strips, as well as specify source and insert points for output busses. The Pickoffs page also provides master control for Delay Compensation.

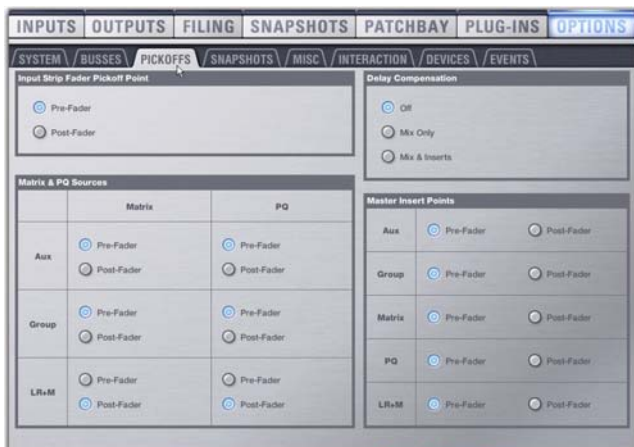

Pickoffs tab of the Options page

Pickoff options are explained throughout this guide where relevant.

Settings for Delay Compensation

The Options > Pickoffs page provides three settings for Delay Compensation: Off, Mix Only, and Mix and Inserts.

Off No Delay Compensation is applied.

Mix Only VENUE automatically compensates for delays incurred by the use of Groups routed to the Mains busses.

Mix and Inserts VENUE automatically compensates for delays incurred by the use of plug-ins as well as those incurred by the use of Groups routed to the Mains busses.

Snapshots

The Snapshots page provides several snapshot preference settings to optimize Snapshot operation.

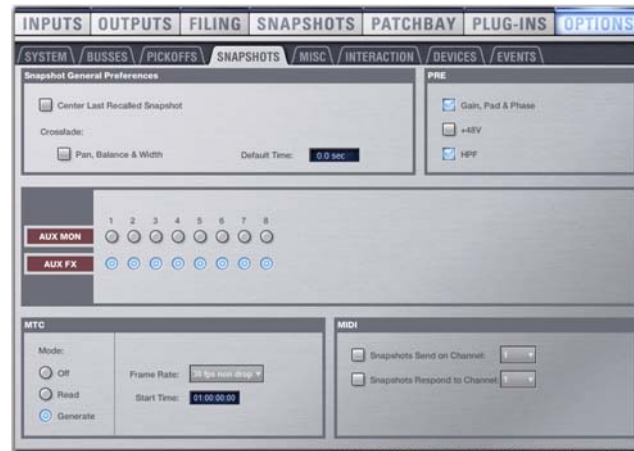

Snapshots tab of the Options page

Snapshot General Preferences

The following settings are available in the Snapshots page.

Center Last Recalled Snapshot Manages the display of the Snapshots list so that the last recalled snapshot is always centered vertically, letting you maintain display of adjacent snapshots in the list.

Crossfade

All snapshots provide a Crossfade setting that determines how long scoped faders will crossfade to the stored values in that snapshot when it is recalled. The Options > Snapshots page provides the following settings for optimizing crossfades between snapshots.

Default Time Defines a (fader) Crossfade time to apply to all new snapshots.

Pan, Balance & Width Enables pan, balance and width on scoped channels to crossfade.

 For more information, see Chapter 21, “Snapshots.”

PRE

The options in the PRE section let you specify which parameters are recalled with Snapshots whose scope includes Pre settings. Click to toggle whether recalled Input snapshot data includes the following:

- Gain, Pad, and Phase
- +48V (phantom power)
- HPF

 Delay is stored as a unique (discrete) data type for each channel.

Aux Mon and Aux FX

These settings let you classify individual Aux Sends (including linked bus pairs) as monitor sends (“Mon”) or as effects sends (“FX”), which lets you scope each type separately from the Snapshots page.

This option is for organizing Aux Sends and Var Group Sends for snapshot control only, and does not directly affect Aux bus operation.

MTC (MIDI Time Code)

The MIDI Time Code options let you control MTC operational modes, frame rate, and Start Time.

Modes Available MTC modes are MTC Off, MTC Read (slave), and MTC Generate (master).

Frame Rate This option sets the frame rate that is used when generating MTC.

Start Time This option sets the start time that is used when generating MTC.

MIDI

Designates the channel on which snapshots send or receive MIDI Bank Select and Program Change information.

 See Chapter 23, “Synchronization.”

Snapshots Send on Channel This option sets snapshots to send Bank Select and Program Change commands on a selected MIDI channel. This provides a quick and easy way to send a MIDI command every time a snapshot is fired, without having to embed a MIDI program change within each snapshot.

Snapshot Send on Channel does not need to be turned on in order to send other types of MIDI data that *are* embedded in snapshots, such as note on/off or MMC.

Snapshots Respond to Channel This option sets snapshots to respond to incoming Bank Select and Program Change commands on the selected MIDI channel.

MIDI Snapshot Output Safe Safes (shuts off) VENUE MIDI output when snapshots are recalled. This does not affect sending of Bank Select and Program Change commands with the Snapshots Send on Channel option.

Misc

The Miscellaneous page provides utility and other settings.

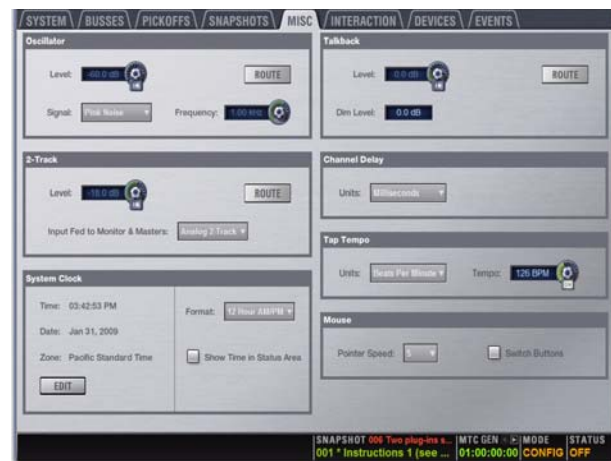

Misc tab of the Options page

Oscillator

Lets you choose the tone, frequency, and level for the built-in oscillator, and route it to an available output.

Signal Lets you choose the type of oscillator tone to use. Choices include sine, variable sine, and noise.

Frequency Lets you set the oscillator frequency.

Route Enables Route Osc to Selected mode, to assign the oscillator signal to the currently selected output channel(s).

2-Track

Lets you set the level and input source for the 2-Track analog and digital inputs, and route them to the desired outputs.

2-Track Level Lets you activate 2-Track input and set 2-Track input level.

2-Track Input Selects which 2-Track input (analog, or digital) is fed to the monitors and output busses.

Route Enables Route 2-Track to Selected mode, to assign the 2-Track signal to the currently selected output channel(s).

Talkback

Talkback Level Lets you activate Talkback and set Talkback input level.

Talkback Dim Level Sets the dim level, which is the amount of attenuation applied to the mix on the output bus when Talkback is activated.

Route Enables Route Talkback to Selected mode, to assign the Talkback signal to the currently selected output channel(s).

Routing Osc, 2-Track and Talkback

Use the Patchbay to assign the Oscillator, 2-Track inputs, or Talkback input to an Input or FX Return fader.

You can use the on-screen Route buttons to route oscillator, 2-track and talkback signals to outputs.

To route the Oscillator, 2-Track, or Talkback outputs on-screen:

- 1 In the Options > Misc page, click the Route button in either the Oscillator, 2-Track, or Talkback sections.
- 2 Do either of the following:
 - If you had already selected the desired output, click to confirm the currently displayed Route To mode (in the lower left corner of the screen).
 - Go to the Outputs page and click to select an output (it flashes briefly, otherwise the Outputs page remains focussed on the currently selected Output channel).
- 3 In the confirmation dialog that appears, click Route to confirm your assignment or click Cancel to cancel without changing the current routing.

For more information, see Chapter 12, “Patchbay.”

System Clock

Sets the date and time for the system.

Time of Day in Status Display

You can choose to show time of day in the lower right corner of the screen in the Status display area. This optional display can be configured for either 12 hour (AM/PM) or 24 hour format as follows:

To show time of day in the Status area:

- 1 Go to the Options > Misc page.
- 2 In the System Clock section, enable the Show Time in Status Area option.
- 3 Select a format for the displayed time: 12 hour (AM/PM) or 24 hour.

Time of day is shown whenever the status of the plug-in racks is OK; plug-in rack status messages (if any) temporarily replace time of day display to alert you to plug-in rack status.

Channel Delay

Lets you set the display units on all applicable input and output delay controls. This makes it possible to set the delay based on any of the following:

- delay time (in milliseconds)
- distance to the source (in feet or meters)
- number of samples of delay

Tap Tempo

Lets you set the global system tempo, toggle system tempo on/off, and choose to display tempo in BPM or ms.

On Turn on the global tempo sync by clicking the On switch directly below the encoder so that it is lit (on).

Tempo Sets a system tempo value using the encoder or by typing a value directly into the Tempo field.

Units Lets you choose Beats Per Minute (BPM) or Milliseconds as the units for displayed values.



Tap Tempo controls in the Options > Misc page

 For more information, see “Tap Tempo for Plug-ins” on page 214.

Mouse

Pointer Speed and Mouse L/R Settings

You can customize the response speed for the trackball (or mouse) and on-screen cursor, and reverse the left/right assignment of the Trackball buttons, from the Options > Misc page.

To customize Pointer Speed:

- 1 Go to the Options > Misc page.
- 2 Do any of the following:
 - To adjust cursor speed, click the Pointer Speed pop-up menu and choose a higher value for faster response, or a lower value for a slower response.
 - To reverse the left/right assignment of the two Trackball buttons, click to enable Switch Buttons.

Interaction

The Interaction page lets you configure behaviors for the Selected Channel (ACS) sections, Input Safe Switches, Lights, Meter, Ethernet, and LCD Display.

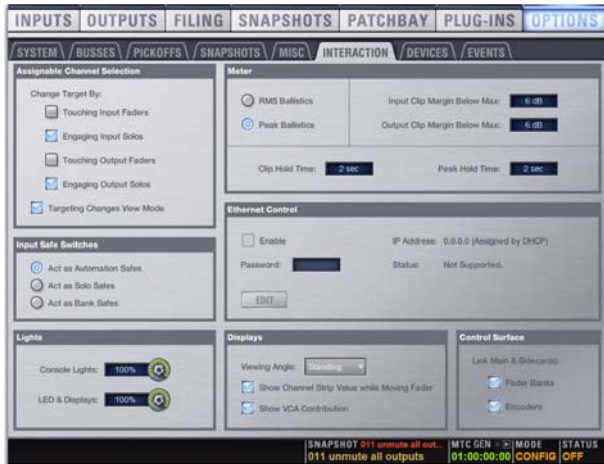

Interaction tab of the Options page

Assignable Channel Selection

Options in this section set the mechanism by which channels are targeted on the Selected Chan sections (also known as the ACS, or Assignable Channel Section).

To customize console and screen interaction:

- 1 Go to the Options page and click the Interaction tab.
- 2 Set the following Assignable Channel Selection options:

Change Target By

The Change Target By options let you specify whether the following actions target a channel on the ACS. More than one option can be selected simultaneously.

- Touching Input Faders
- Engaging Input Solos
- Touching Output Faders
- Engaging Output Solos

Targeting Changes View Mode

The Targeting Changes View Mode option updates the on-screen display to show the page for the channel targeted. When this option is deselected, the on-screen display does not update when a channel is targeted.

Meter

Metering settings provide the following options for meter ballistics, peak, and clip indication.

Ballistics This option lets you choose RMS or Peak ballistics for the control surface and on-screen meters.

Input Clip Margin and Output Clip Margin These options set the level, relative to the maximum (full scale) level, at which a clip is reported on a channel. When a clip is detected, the entire channel meter turns red.

To set Input or Output clip margin:

- 1 Click in the dB Below Max edit box for Input Clip Margin or Output Clip Margin.
- 2 Enter a value or drag to change the value and press Enter.

The entered value is interpreted as a relative dB value from the maximum (where “Max” is considered +20 dBVU). For example, with the Input Clip Margin set to 6 dB below max (the default), peak levels within 6 dB of maximum level will trigger a clip indication

Clip Hold Time and Peak Hold Time These options specify how long clips and peaks are held. Default is 2 seconds for both Clip and Peak hold.

Input Safe Switches

The Input Safe Switches let you control three independent Safe functions: Automation Safe, Solo Safe, and Bank Safe. Only one of these Safe functions can be viewed and controlled at a time.

Act as Automation Safes When selected, this option sets the console Safe switches and on-screen channel Safe buttons to toggle the Automation Safe status of the corresponding channel. For more information, see Chapter 21, “Snapshots.”

Act as Solo Safes Solo Safe applies only to Input Channels and FX Returns. When selected, this option sets the Safe switches to toggle the Solo Safe status of the corresponding channel. See “Solo Bus Operation” on page 123.

Act as Bank Safes When selected, this option sets the Safe switches of Input Channels and FX Returns to toggle that channel’s Bank Safe Status. (Bank Safe keeps channels at the top fader layer, immune to input banking.) For more information, see “Bank Safe Mode” on page 40.

Ethernet Control

Ethernet Control settings let you configure ECx Ethernet Control for remote control of the VENUE system over a wireless Ethernet network.

 For more information, see Chapter 30, “ECx.”

Lights

Console and LED/Display settings let you adjust the brightness of the following items:

Console Lights Adjust brightness of external lights connected to the Console Lights connectors on the back panel.

LEDs and Displays Adjust brightness of LED and LCD displays on the control surface.

Displays

These options let you customize the behavior of the control surface LCDs.

Viewing Angle This option lets you configure the Selected Channel and Snapshots LCD displays for optimum viewing.

Show Channel Strip Value While Moving Fader This option determines what is displayed in the Channel Name display when a fader is adjusted. When selected (default), the Channel Name display switches from showing channel name to showing the value (level) when a fader is adjusted. When deselected, the Channel Name displays do not show values when a fader is adjusted.

Show VCA Contribution This option lets you display a secondary, transparent fader cap on each on-screen fader strip that represents the effective gain of the channel (channel gain plus associated VCA gain, if any). For more information, see “Assigning and Using VCAs” on page 84.

Control Surface

These options let you link or unlink faders and encoders across Main and Sidecar units.

Link Main and Sidecars These options provide separate link states for faders banks and encoders. When selected, fader banks (or encoders) bank and assign globally across all units. When deselected, faders can be banked locally to each unit (Main or Sidecar), and encoders can be assigned uniquely on each unit.

Events

The Events tab of the Options page lets you use the Event List to customize the function switches and footswitches. For information, see Chapter 22, “Events.”



Options > Events page

Plug-Ins

The Plug-Ins tab of the Options page is used to install plug-ins on the VENUE system. The Plug-Ins tab is available on complete VENUE systems only. It is not available in the Stand-alone software.

Part III: Signal Routing

Chapter 7: Inputs and Input Routing

This chapter shows how to do the following:

- Configure inputs (system settings for input channels), name channels, Make Stereo and Split to Mono)
- Assign input sources to Input Channels in the Patchbay
- Route input channels to Mains, Groups, and Aux Sends, to Matrix mixers and other output busses, and to plug-ins
- Adjust input channel parameters

Configuring Inputs

Two types of inputs are available: Input Channels and FX Returns.

Input Channels

Input Channels are used to control inputs from stage and mix position (local) audio inputs, from Pro Tools, or from bus-fed plug-ins.

Input channels can be mono or stereo. Each mono channel controls one input, and each stereo channel controls two inputs in tandem. Input channels can appear on any of the input channel strips. Up to 96 mono input channels, maximum, are available, depending on your system and rack configuration. Input channels are displayed in banks on the 16 control surface input channel strips.

FX Returns

Effects Return channels (or *FX Returns*) are used to control signals from bus-fed plug-ins, from external hardware, or from Pro Tools.

FX Returns are always stereo, and appear on input channel strips 1–8 and 9–16. Up to 16 stereo FX Returns are available.

Configuring Input Channels

To set the number of available Input Channels:

- 1 Put the system into Config mode.
- 2 Go to the Options page and click the System tab.
- 3 Click Edit.
- 4 Choose the number of channels from the Input Channels pop-up menu.
- 5 Click Apply. The system restarts with the new Input Channel configuration.

 *Audio will be interrupted when this configuration change is applied.*

Configuring FX Returns

VENUE D-Show systems provide up to 16 stereo FX returns. You can choose to use either 8 or 16; choosing fewer FX Returns leaves more DSP available for plug-ins. For details, see “Configuring FX Returns” on page 63.

Combining Input Channels (Make Stereo)

Pairs of mono input channels can be combined to make stereo channels, whose left and right sides are then controlled by one input channel strip.

To combine two mono input channels into a single stereo channel from the console:

- 1 Put the system into Config mode.
- 2 Press the Make Stereo switch in the Fader Control section. The Make Stereo switch flashes when this function is active.
- 3 Press the Select switches on the mono channels you want to combine. The channels do not need to be contiguous.
- 4 Press the flashing Make Stereo switch to confirm.

To combine two mono input channels into a single stereo channel on-screen:

- 1 Put the system into Config mode.
- 2 Select two mono channels by doing either of the following:
 - On the console, press and hold the Multi-Select switch, then press Select on each of the two mono channel strips you want to combine.
 - or –
 - On-screen, go to the Inputs page and click a fader strip to select the first mono channel, then hold Shift and click to select the second mono channel you want to combine.
- 3 Right-click either of the selected mono channels on-screen and choose Make Selected Mono Strips Stereo.



Two mono inputs about to be combined into one stereo channel

Each selected channel is combined with the next-highest selected channel, even if the selected channels are not contiguous. Blank strips are created and inserted where necessary to maintain channel layout in that bank. Parameter values from the leftmost channel of each pair are applied to both channels, and the pan control becomes a Balance/Width control.

Combined channels are shown in the patchbay as left and right sides of the Input Channel name. FX Returns are always stereo, so they cannot be combined or split.

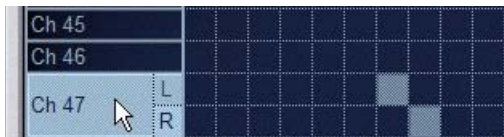

Stereo Input Channel in the Patchbay Input page

On the console, the channel St (Stereo) LED lights to indicate that a channel is a stereo channel.

To split stereo channels and make them mono from the console:

- 1 Put the system into Config mode.
- 2 Press the Make Stereo switch so that it flashes.
- 3 Press the Select switches on the stereo channels you want to split into mono channels.
- 4 Press the flashing Make Stereo switch to confirm.

To split a stereo channel into two mono channels on-screen:

- 1 Put the system into Config mode.
- 2 Select the stereo channel you want to split.
- 3 Right-click the selected channel and choose Split Selected Stereo Strip to Mono.

Each selected stereo channel is split, placing the channels next to each other on the console and in the Patchbay. Blank strips are deleted to maintain channel layout.

Naming Channels

Input Channel and FX Return channel names can be changed from the Inputs page or from the Patchbay.

To change the name of an Input Channel or FX Return channel:

- 1 Go the Patchbay page and click the Inputs tab.
- 2 Target the channel whose name you want to change by pressing its Select switch or selecting it on-screen.
- 3 Double-click the channel name.



Changing the name of an Input Channel in the Inputs page

- 4 Type a new name and press Enter on the computer keyboard.

 When naming channels in the Patchbay, you can double-click the channel name shown in the columns of the grid and type a name; press Tab on the keyboard to go to the next channel and Shift+Tab to go to the previous channel.

Assigning Input Sources to Channels

Input sources are assigned to Input Channels or FX Returns in the Patchbay. Available input sources for Input Channels or FX Returns include:

- Stage inputs (Stage Rack, or Mix Rack stage I/O)
- Local FOH inputs (FOH Rack (or Mix Rack) 2-Track sources, Talkback, Oscillator)
- Pro Tools outputs (HDx or FWx)
- Plug-In outputs

To assign an input source to an Input Channel or FX Return:

- 1 Go to the Patchbay page and click the Inputs tab.
- 2 To the left of the channel grid, click the Channels tab or the FX Returns tab.
- 3 Click the Stage, FOH, or Pro Tools tab to display the desired type of input sources. On systems using two Stage Racks, separate tabs appear for Stage 1 and Stage 2.
- 4 Click in the channel grid to assign an input source to an Input Channel or FX Return.



Assigning input sources in the Patchbay Inputs page

The Inputs tab of the Patchbay shows the input source and destination above the grid. Input source is also shown below the channel name in the Inputs and Patchbay Inputs page.

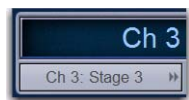

Input source assignment shown in the Inputs page

A single input source can be assigned to multiple Input Channels or FX Returns (you can fan out a source to multiple channels). Gain control, phantom power and pad settings are linked across the channels. Each Input Channel or FX Return may be fed by only one input source (multiple sources cannot be routed to a single channel).

Assigning Bus-Fed Plug-Ins, Osc/Talkback/2-Track

Bus-fed plug-ins can be patched to Input Channels and FX Returns from the Plug-In Rack (see “Using Plug-Ins as a Bus Processor” on page 160).

You can also route the built-in Oscillator, Talkback input, and 2-Track sources to input channels (see “Routing the Oscillator” on page 130).

Routing Input Channels

Input channels and FX Returns can be routed to the Mains, Groups/Var Groups, Auxes, Matrix mixers and PQ busses.

Routing Channels to the Mains and Groups Busses

Input channels and FX Returns can be routed to the Mains and Groups busses using the Bus Assigns section of the ACS.

To route one or more input channels to Mains and Groups busses on the console:

- 1 Do either of the following:
 - To select a single channel, press its Select switch.
 - To select multiple channels, press Select on the first channel, hold the Multi-Select switch (located to the left of the input faders), then press the Select switches on the other channels.
- 2 To route to Mains, press the L-R (left and right) and/or C/Mono (center/mono) switch in the Bus Assigns section so that is lit.
 - or –
 - To route to a Group bus, press a Groups 1–8 switch.

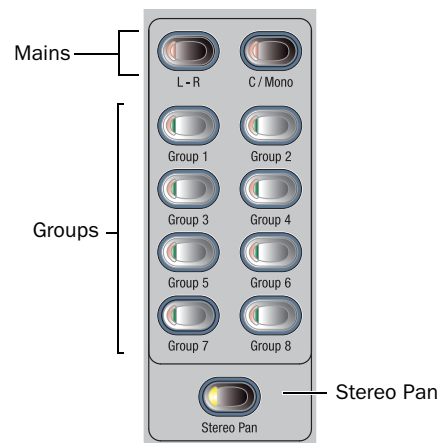

Bus Assign switches in the ACS

The L-R, C/M and 1–8 Bus Assign LEDs on each channel light to indicate routing to the corresponding busses.

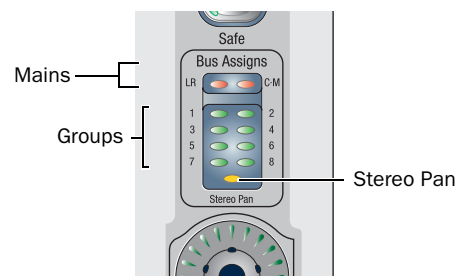

Bus Assign LEDs

To route channels to Mains or Groups on-screen:

- 1 Select one or more channels.
- 2 Go to the Inputs page.
- 3 Click the Bus Assign buttons to route to those busses.

 For information on configuring the system Mains as L-R plus Mono, or as L-C-R, see “Configuring Aux, Group, and Variable Group Busses” on page 76. For more information on configuring Group busses, see “Configuring Aux, Group, and Variable Group Busses” on page 76.

Routing Channels to Aux Sends

Input channels and FX Returns can be routed to Aux sends using the input encoders, using the ACS, or on-screen.

To route channels to Aux sends using the input encoders:

- 1 Press an Encoder assign Aux switch 1–2 through 15–16 (either row).
 - The first press of an Aux Send switch assigns level control of the odd-numbered send to the encoders. The switch lights green to indicate an odd-numbered selection.
 - The second press of an Aux Send switch assigns level control of the even-numbered send to the encoders. The switch lights yellow to indicate an even-numbered selection.

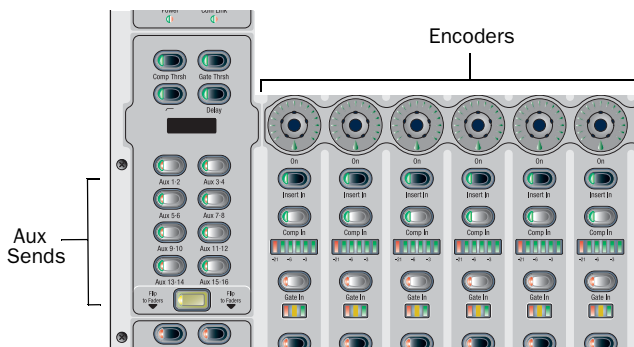

Encoder assignment switches for input channels

- 2 For each channel you want to assign to the selected Aux Send bus, press its channel encoder so that its “On” indicator LED lights.
- 3 To set the Aux Send level, do either of the following:
 - Turn the encoder on each channel.
 - Press the Flip to Faders switch, then adjust the channel fader.

To route channels to Aux Sends busses using the ACS:

- 1 Do either of the following:
 - To select a single channel, press its Select switch.
 - To select multiple channels, press Select on the first channel, hold the Multi-Select switch (located to the left of the input faders), then press the Select switches on the other channels.
- 2 In the Aux Sends section, press an Aux Sends encoder to enable that send.
- 3 Rotate the encoder to adjust that send level.

Configuring Aux Busses (Aux Sends)

VENUE systems can be configured to have 8 or 16 Aux busses as part of the overall Aux/Group bus configuration. Mono Aux busses can be linked in odd/even pairs to function in stereo (see “Configuring Aux and Variable Group Busses” on page 93).

Routing Channels to Variable Groups

To access Variable Group sends:

- 1 Make sure the system is configured for Variable Groups mode. (See “Configuring Aux, Group, and Variable Group Busses” on page 76.)
- 2 Select one or more input channels.
- 3 Press the Stereo Pan switch in the Aux Sends section of the ACS Bus Assigns. Or, click the Var Groups button in the on-screen Bus Assign section (on the Inputs page for the selected channel). Variable Groups 1–8 are now mapped to the ACS Aux Send section.
- 4 Press an encoder to enable the selected (Var Group) Aux Send.
- 5 Rotate the encoder to adjust send level.
- 6 For more information, see Chapter 10, “Aux Sends and Variable Groups.”

Routing Channels to Matrix and PQ Busses

Matrix and PQ source assignments determine input signal routing to each of the Matrix and PQ mixers. Matrix and PQ source inputs can include up to 12 inputs per mixer.

Matrix and PQ signal routing is performed from the Matrix and PQ tabs of the Outputs page (see Chapter 11, “Matrix and Personal Q Mixers”).

Assigning Channels to VCAs

Channels can be assigned to VCAs for consolidated control of multiple channels.

To assign one or more channels to a VCA:

- 1 Press the VCA switch to bank the Output Faders to VCAs.
- 2 Select the VCA (1-8) you wish to assign to by pressing its Select switch.
- 3 Press the Multi Assign switch near the Output encoders. While engaged, the Multi Assign and output Select switch LEDs flash.
- 4 Press the Select switch on the inputs or outputs you want assigned to the currently targeted VCA. Use the Input and Output Fader bank switches to access the desired channel strips.
- 5 Press the Multi Assign switch again to confirm the action.
– or –

Select another VCA to confirm the current assignment but remain in Multi Assign mode for the newly targeted VCA.

For more information on VCAs, including using VCA spill, see “Assigning and Using VCAs” on page 84.

Routing Inputs to Direct Outputs

All Input channels and FX Returns have Direct Outputs, which can be assigned to hardware outputs, used as inputs to plug-ins, and sent to Pro Tools. Direct Outs are assigned in the Patchbay, and can be controlled from the ACS or on-screen.

To enable and adjust Direct Outputs:

- 1 Select the input or FX return channel.
- 2 Press the Direct Output encoder to toggle it in and out on the selected channel.
- 3 Rotate the Direct Output encoder to adjust the output level.

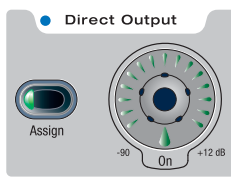

Direct Output encoder

For more information on routing and assigning Direct Outputs, see “Direct Outputs” on page 83.

Using Built-In Dynamics and EQ

Each Input Channel has built-in Dynamics processors, a High-Pass Filter and a 4-band EQ; each FX Return has a built-in 2-band EQ. If the channel is a stereo channel, the processor controls are linked and apply to both the left and right sides of the channel.

Using Dynamics on Channels

A built-in Compressor/Limiter and Expander/Gate are available on each Input Channel. You can engage and adjust dynamics threshold directly from each input channel. Controls for all of the built-in dynamics processors are provided in the ACS Dynamics section, and an input/output curve appears on-screen.

Compressor/Limiter

To engage the built-in Compressor/Limiter on the selected channel:

- Press the Comp In switch on the channel.
– or –
- Target the channel by pressing its Select switch, then press the Comp/Lim In switch in the ACS Dynamics section.

To engage the built-in Compressor/Limiter on any input channel:

- 1 Bank to the desired channels.
- 2 In either the upper or lower Encoder Assignment sections, press the Comp Thrs switch to assign that input encoder row to the built-in Compressor/Limiter.
- 3 Push the encoder on each channel you want the built-in Compressor/Limiter engaged.

To adjust the Compressor/Limiter threshold from a channel:

- 1 In the Encoder Assignment section, press the Comp Thrs switch.
- 2 Turn the assigned encoder to set the Compressor/Limiter threshold value.

To adjust Compressor/Limiter controls from the ACS:

- 1 Target a channel by pressing its Select switch.
- 2 Press the Select switch next to the Comp/Lim In switch in the ACS Dynamics section. The switch lights to indicate control of the Compressor/Limiter.

Expander/Gate

To engage the built-in Expander/Gate on the selected channel:

- Press the Gate In switch in the channel.
 - or –
- Target the channel by pressing its Select switch, then press the Exp/Gate In switch in the ACS Dynamics section.

To engage the built-in Expander/Gate on any input channel:

- 1 Bank to the desired channels.
- 2 In either the upper or lower Encoder Assignment sections, press the Gate Thrs switch to assign the input encoders to the built-in Expander/Gate.
- 3 Push the encoder on each channel you want the built-in Expander/Gate engaged.

To adjust the Expander/Gate threshold from a channel:

- 1 In the Encoder Assignment section, press the Gate Thrsh switch.
- 2 Turn the assigned rotary encoder to set the Expander/Gate threshold value.

To adjust Expander/Gate controls from the ACS:

- 1 Target a channel by pressing its Select switch.
- 2 Press the Select switch next to the Exp/Gate In switch and meter in the ACS Dynamics section. The switch lights to indicate control of the Expander/Gate, and indicator LEDs below each encoder light red to show that these controls are mapped to Exp/Gate functions.

Using EQ on Channels

A built-in High-Pass Filter and 4-band EQ are available on each Input Channel and a 2-band EQ is available on each FX Return. One of two EQ types can be selected for the built-in EQ, on a per-channel basis: a full-spectrum parametric digital EQ or an analog-modeled EQ.

Modular controls for all of the built-in EQ processors are in the ACS EQ section, and an EQ response curve appears on-screen.

To use the built-in EQ on a channel, do one of the following:

- 1 Target the channel by pressing its Select switch.
- 2 Do any of the following:
 - To engage the channel High-Pass Filter, press the HPF switch in the Encoder Assignment section. Toggle HPF in/out on each channel by pressing the assigned encoders; adjust HPF frequency by rotating those encoders.
 - To engage the built-in 4-band or 2-band EQ, press the EQ In switch on the channel (or in the ACS EQ section).

 For more information, see Chapter 17, “EQ.”

Using Inserts on Channels

You can use software plug-in inserts or hardware inserts on any Input Channel or FX Return.

Using Plug-Ins on Channels

Plug-Ins are arranged in virtual racks, which allow signals to be sent to and from each plug-in as if it were an external processor. Plug-Ins can be used in two ways: as inserts, or as bus-fed effects in a Send/Return arrangement.

Insert The plug-in is patched in at the insert point on an Input Channel or FX Return. Each Input Channel may have up to four plug-in inserts.

Send/Return Signal is sent to the plug-in over any of the system busses (usually an Aux Send) and routed back to an Input Channel or FX Return.

For more information on using plug-ins in a Send/Return arrangement, see “Using Plug-Ins as a Bus Processor” on page 160.

Inserting Plug-Ins on Channels

You can insert plug-ins on Input Channels and FX Returns directly from the Inputs page or from the Plug-In Rack.

To insert a plug-in on a channel:

- 1 Go to the Inputs page and target the channel where you want to insert the plug-in.
- 2 In the Inserts section of the Inputs page, do one of the following:
 - Click one of the four Plug-In Insert pop-up menus and choose a plug-in from one of the Plug-In Rack submenus.
 - or –
 - Click one of the four Plug-In Insert buttons to go to the Plug-In Rack, then route the signal to the plug-in using Plug-In Rack controls.



Choosing a plug-in (left) and navigating to the racks (right)

The name of the plug-in appears in the on-screen Plug-In Insert display.

 See Chapter 18, “Plug-Ins.”

Using Hardware Inserts on Channels

You can insert external processors in the signal chain of input channels and FX Returns.

💡 *Outputs also provide hardware inserts. For more information, see “Using Inserts on Output Busses” on page 78.*

Assigning Hardware Inserts to Inputs

You can assign hardware inserts to Input channels and FX Returns directly from the Inputs page or from the Patchbay.

To assign a hardware insert to an input:

- 1 Go to the Inputs page and target the channel where you want to assign the hardware insert.
- 2 In the Inserts section of the Inputs page, do one of the following:
 - Click the Hardware Insert pop-up menu and choose an insert destination directly from the menu.
 - or –
 - Click the Hardware Insert button to go to the Inserts page of the Patchbay, and assign the insert from the Patchbay.

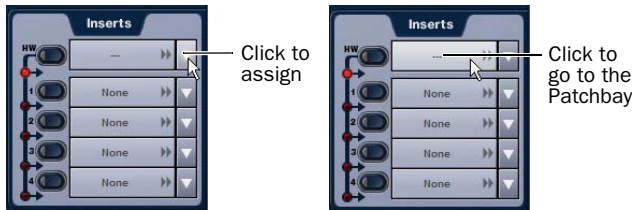

Choosing a destination (left) and jumping to the Patchbay (right)

The name of the hardware insert destination appears in the on-screen Hardware Insert button.

Setting the Hardware Insert Location

You can choose the location of the hardware insert in the signal path, relative to the four plug-in inserts, for each channel. A hardware insert does not need to be currently assigned to do this.

To set the hardware insert location:

- 1 Go to the Inputs page and target the channel where you want to set the hardware insert location.

- 2 In the Inserts section of the Inputs page, click the hardware insert indicator so that it lights red.

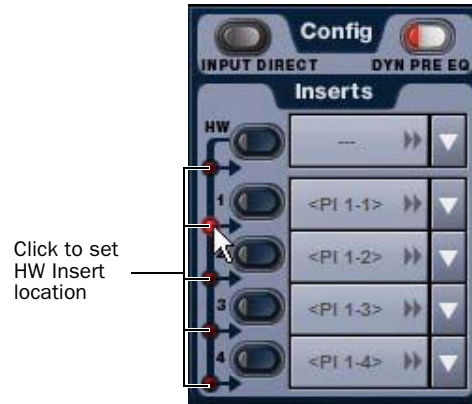

Setting a hardware insert location in the Inputs page

Activating and Bypassing Inserts

After hardware and plug-in inserts are assigned, they can be activated and bypassed from the ACS section or the corresponding Input page controls.

To activate or bypass a plug-in insert from the ACS section:

- 1 Target the channel by pressing its Select switch.
- 2 Press any of the Plug-In switches in the Insert Processing section to activate or bypass the corresponding Insert. The switch lights when the insert is activated.

To activate or bypass a hardware insert from an input channel or FX Return:

- Press the Insert In switch on the channel. The switch lights when the insert is in-circuit.

To activate or bypass a hardware insert on-screen:

- 1 Go to the Inputs page and target the channel.
- 2 Click the In/Out switch for the HW insert (at the top of the Inserts section) on the channel. The switch lights when the insert is in-circuit.

Adjusting Input Controls

Input Gain

Input Gain is adjustable from the rotary encoders on each Input channel and FX Return. Mic inputs have a gain range from +10 dB to +60 dB. Analog line inputs and digital inputs have a gain range from -20 dB to +18 dB.

Gain Guess Feature

The automated Gain Guess function can be used to set a nominal level for a channel based on its incoming signal. When you press and hold a rotary encoder assigned to input gain, the system samples incoming signals and automatically sets the channel gain and pad for a 0 dB reference when the encoder is released. Gain Guess follows the current Meter mode (Peak or RMS).

Gain Indicators

When Gain is displayed on the input encoders, the encoder's indicator LED lights to indicate that the gain is set to the default value (+10 dB for analog inputs, and 0 dB for digital inputs). Gain change is indicated by the encoder ring LEDs, and gain value is shown in the channel display when adjusted.

Setting Input Gain

Gain can be controlled from individual channel strips or from the ACS section.

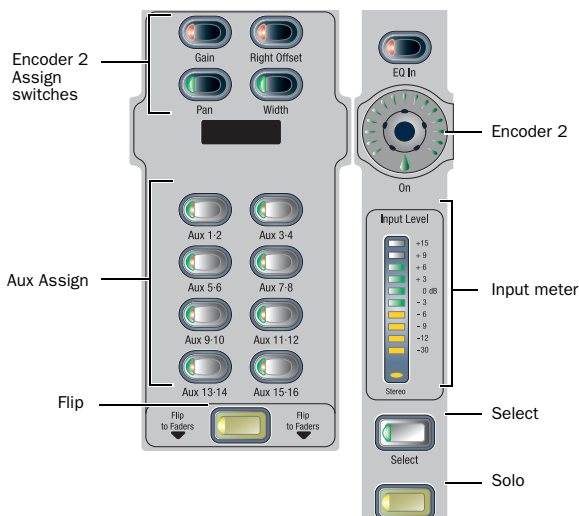

Input controls on input channel strips

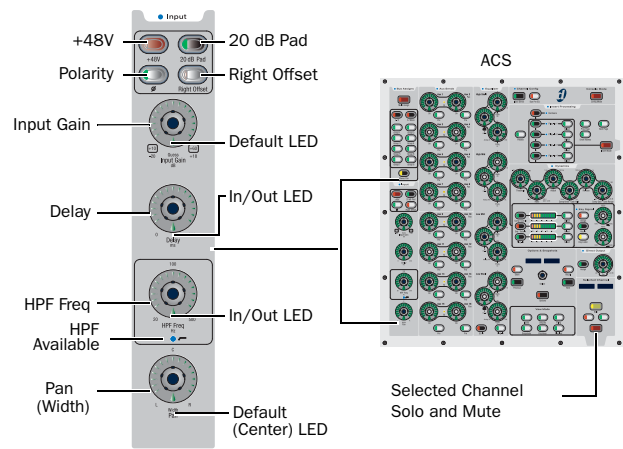

Input controls and their location in the ACS

To adjust input gain for a channel:

- Do one of the following:
 - In the Encoder Assignment section, press the Gain switch to assign gain control to the bottom row of rotary encoders.
 - or –
 - Target the channel by pressing its Select switch. Gain control for the channel is assigned to the Input Gain rotary encoder in the ACS section.
- Adjust the gain by turning the assigned rotary encoder

To set input gain using the Gain Guess feature:

- Press and hold the assigned rotary encoder while the channel is receiving input signal. The LED flashes to indicate level sampling.
 - or –
 - Click Guess on-screen.
- Release the rotary encoder to the current gain guess. Gain will be set so the incoming signal reaches 0 dB peak (if Peak mode is selected) or 0 dB RMS (if RMS mode is selected).

Setting Right Offset on Stereo Channels

On stereo input channels and FX returns, the Gain control affects both the left and right channels. The Right Offset feature lets you offset the gain of the right channel relative to the left channel by -20 dB to $+20$ dB, within the overall gain limits.

To adjust channel gain offset for a stereo channel from the console:

- 1 Do either of the following:
 - In the Encoder Assignment 2 section, press the Right Offset switch to assign offset control to the bottom row of encoders.
 - or –
 - Target the channel by pressing its Select switch, then press the Right Offset switch in the ACS Input section. Channel Gain Offset is assigned to the Input Gain rotary encoder in the ACS Input section.
- 2 Adjust the right channel gain offset by turning the assigned rotary encoder.

To adjust channel gain offset for a stereo channel on-screen:

- 1 Go to the Inputs page and target the stereo channel.
- 2 Adjust the right channel gain using the on-screen Right Offset encoder.

Stereo Level Offset Indication

The Stereo LED below the channel meter flashes when the difference in signal level between the left and right channels is 12 dB or greater.

Pan/Balance

Pan adjusts channel pan (for mono input channels) and stereo balance (for stereo input channels and FX returns).

To adjust channel pan/balance from the encoders:

- 1 In the Encoder Assignment 2 section, press the Pan switch to assign pan/balance to those rotary encoders.
- 2 Adjust channel pan/balance by turning the encoders.

Stereo Width

Width adjusts the stereo image of stereo input channels and FX returns by controlling ganged pan positions of the left and right channels, in opposite directions.

Width can be adjusted from full L–R, to mono, to full reversed L–R. Width controls are not available on mono channels.

To adjust the width of a stereo channel:

- 1 Do one of the following:
 - In the Encoder Assignment 2 section, press the Width switch to assign width to the bottom row of encoders.
 - or –
 - Target the channel by pressing its Select switch, then press the Width/Pan rotary encoder in the ACS section to toggle control of width and pan/balance.
- 2 Adjust width by turning the assigned encoder. Turning the encoder clockwise moves the width to full stereo, and counter-clockwise moves the width to reverse stereo. The center position represents mono.

To adjust width of a stereo channel on-screen:

- 1 Select one or more stereo channels.
- 2 In the Inputs page, adjust width by turning the on-screen Width encoder. Turning the encoder clockwise moves the width to full stereo, and counter-clockwise moves the width to reverse stereo. The center position represents mono.

High-Pass Filter

A built-in 4th-order High-Pass Filter can be engaged on each input channel. The HPF corner frequency range is from 20 Hz to 500 Hz.

To engage the built-in HPF:

- 1 Do one of the following:
 - In the Encoder Assignment section, press the HPF curve switch to assign HPF control to the top row of rotary encoders.
 - or –
 - Target the channel by pressing its Select switch. HPF control is assigned to the HPF Freq encoder in the ACS.
- 2 Press the assigned encoder to engage the filter in that channel. The channel HPF indicator LED lights blue when the HPF is in circuit.
- 3 Adjust the HPF corner frequency by turning the assigned rotary encoder.

Phantom Power

48V phantom power can be applied to any analog stage input assigned to an input channel or FX return.

To apply phantom power to an input:

- 1 In the patchbay, assign a stage input to a channel. See “Assigning Input Sources to Channels” on page 65.
- 2 Target the channel by pressing its Select switch.
- 3 Press the +48V switch in the ACS Input section. The switch lights when phantom power is applied.

 *If an input is moved to a different channel, the gain, pad, and phantom power setting will move with the input.*

20 dB Pad

A 20 dB pad can be applied to any analog Stage input assigned to an input channel or FX Return.

To apply a 20 dB pad to a Stage input:

- 1 Target the channel by pressing its Select switch.
- 2 Press the 20 dB Pad switch in the ACS Input section. The switch lights when the pad is applied to the Stage input.

 *The Gain Guess feature turns the Pad on or off as needed to accommodate incoming signal level*

Input Polarity (Phase) Invert

The polarity of any input channel or FX return signal can be inverted. With stereo channels, only the left channel is inverted.

To invert the polarity of a channel:

- 1 Target the channel by pressing its Select switch.
- 2 Press the polarity inversion (Ø) switch in the ACS Input section. The switch lights when the polarity is inverted.

Safe

The Safe switch toggles Automation Safe, Solo Safe, or Bank Safe on/off. The current function of the ACS Safe switch is determined by the current Input Safe switch assignment in the Options > Interaction page.

When a Safe mode is enabled for the currently selected channel, the ACS Safe switch lights if that Safe mode is the currently assign Input Safe Switch mode. Channel safe status is also indicated by the lit or unlit state of each channel strip Safe LED.

To configure the Safe switches for Automation, Solo or Bank mode, see “Input Safe Switches” on page 58.

To toggle the current Safe state of a channel:

- 1 Target the channel by pressing its Select switch.
- 2 Press the Safe switch in the ACS Input section. The switch lights solid when the current channel is Automation Safe, flashes when the channel is Solo Safe, and flashes rapidly when in Bank Safe.

Delay

A variable delay can be applied to any input channel or FX return. The delay range is from 0 to 250 milliseconds.

To apply delay to a channel from the console:

- 1 Do one of the following:
 - In the Encoder Assignment section, press the Delay switch to assign delay to the top row of rotary encoders.
 - or –
 - Target the channel by pressing its Select switch. Delay control is assigned to the Delay encoder in the ACS.
- 2 Press the assigned rotary encoder to apply delay to the channel. The encoder indicator LED lights when delay is applied.
- 3 Adjust the channel delay value by turning the assigned encoder.

Channel Solo

Three Solo modes are available: Solo In Place (SIP), Pre-Fader Listen (PFL), and After-Fader Listen (AFL), and several options are available for configuring Solo bus operation. Channels can also be implicitly soloed as part of a VCA.

 *See Chapter 14, “Solo and Monitor Busses.”*

To solo a channel:

- Press the channel’s Solo switch. The Solo switch lights solid to indicate the channel is explicitly soloed.

Channel Mute

To explicitly mute a channel:

- Press the Mute switch on the channel. The mute switch lights solid to indicate the channel is explicitly muted.

 *Channels can be muted in three ways: explicitly with the channel mute switch; implicitly as a result of another channel being soloed, and as a member of a Mute Group or VCA. For more information see Chapter 15, “Muting and Mute Groups”*

Channel Level

Channel level can be adjusted from the Input or FX Return faders and using the on-screen faders. The currently selected channel(s) can also be adjusted from the Flex Channel.

Input channel levels can also be affected by VCAs. For more information, see “Assigning and Using VCAs” on page 84.

Channel Faders

Channel Faders provide channel level control from $-\infty$ ($-\text{INF}$) to +12 dB. Use the faders on the console, or on-screen, to adjust individual channel levels.

 For more information on input and output fader banking, see Chapter 5, “Navigating and Selecting Channels.”

Digital Input Sources

On systems that include a DSI (Digital Stage Input) card, the following additional settings and displays are provided.

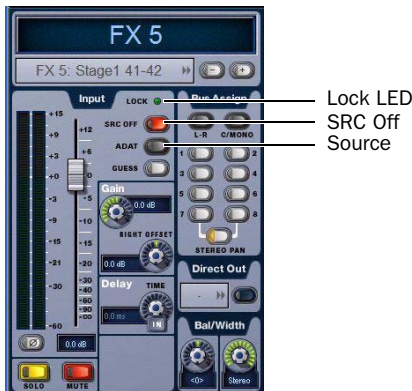

Input controls for a DSI channel

Lock LED Indicates lock status for the channel, and mirrors the same LED on the DSI card.

SRC Off Toggles Sample Rate Conversion on or off for that channel, and mirrors the same LED on the DSI card. A lit SRC Off switch indicates that SRC is disabled.

ADAT (Source) Enables the ADAT Optical port as the active input source on the DSI card. When lit, the DSI card is clocking and listening to corresponding ADAT input; when dark, the channel is receiving input from the corresponding AES input.

Direct Outs are also available on DSI-fed channels, and their pickoff point can be specified in the patchbay.

Using Input Direct

Input Direct mode lets you completely bypass the built-in dynamics and EQ processing, and all inserts on input channels and FX returns. This mode routes the input signal directly from the Top of Channel pickoff to the channel fader.

To bypass all processing on an input channel or FX return from the console:

- 1 Target the channel by pressing its Select switch.
- 2 Press the Input Direct switch in the Channel Config section of the ACS. The switch flashes to show Input Direct mode is active on the selected channel.

To bypass all processing on an input channel or FX return on-screen:

- 1 Target the channel by pressing its Select switch.
- 2 Go to the Inputs page.
- 3 Click the Input Direct button in the Config section of the Inputs page for the selected channel. The button flashes to indicate Input Direct mode is active.



Input Direct button

Chapter 8: Outputs and Output Routing

This chapter shows how to do the following:

- Configure and name Mains, outputs and busses
- Assign outputs and busses to hardware outputs in the Patchbay
- Route outputs to Mains, Groups, Aux Sends, and Matrix mixers
- Using plug-in inserts, and using Graphic EQ on outputs
- Assign and route Direct Outputs
- Adjust output channel parameters
- Use VCAs

Configuring Outputs

The following types of output busses are available: Mains, Groups (or Variable Groups), Auxes, Matrix mixers, and Personal Qs.

Mains

The Main busses can be configured in L-R+M or L-C-R formats. The Main busses are controlled from the dedicated Mains controls and fader in the Output section.

Configuring the Main Busses

The Main busses can be configured to operate as either:

L-R plus Mono Pans signals between the left and right channels to the L-R bus, and sums signals to a separate mono bus.

L-C-R Pans signals across left, center and right channels.

⚠ *Audio may be interrupted or may change levels during this configuration procedure.*

To configure the Main busses:

- 1 Put the system into Config mode.
- 2 Go to the Options page and click the System tab.

- 3 Click Edit.

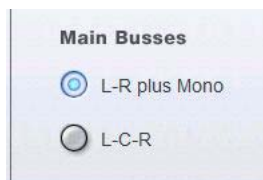

Setting the Main bus configuration

- 4 Select the configuration for the Main Busses.

- 5 Click Apply. The system restarts with the new Main bus configuration.

Groups

Eight Group busses are available. These Group busses can be globally configured to be mono or stereo as part of the system Aux/Group bus configuration. See "Configuring Aux, Group, and Variable Group Busses" on page 76.

Group outputs can be controlled from the faders and encoders in the Output section.

 *See Chapter 9, "Groups."*

Auxes

Up to 16 Aux busses are available. The number of available Aux busses is set as part of the system Aux/Group bus configuration. See "Configuring Aux, Group, and Variable Group Busses" on page 76.

Aux bus outputs can be controlled from the Output faders.

 *For more information, see Chapter 10, "Aux Sends and Variable Groups."*

Variable Groups

When the system is in Variable Groups mode, the 8 Group busses operate in much the same way as Aux busses.

When set to Variable Groups mode, the Output section has 16 available Aux busses and 8 available Variable Group busses, letting you send independently controllable signals to all 24 busses in the system.

Variable Groups mode is set as part of the system Aux/Group bus configuration. See “Configuring Aux, Group, and Variable Group Busses” on page 76.

Matrix Mixers and Personal Qs

Eight Matrix mixers and 8 Personal Q mixers are available. Each Matrix mixer is a discrete 12-in/1-out (mono) submixer, with the ability to link adjacent Matrix mixers into stereo pairs. Each PQ mixer is a discrete 12-in/2-out (stereo) submixer.

Matrix mixer and Personal Q input sources can include up to 12 inputs, selectable from any combination of Aux, Group or Mains busses plus up to 8 unique input channels, FX returns or hardware inputs. Pre- and post-fader tap for Matrix and PQ sources are assigned in the Pickoffs tab of the Options page.

 *User Source input assignments are stored in Snapshots as part of their distinct Matrix or PQ data type.*

Matrix mixer and PQ mixer outputs are controlled from the output faders; matrix inputs are controlled from the encoders when a particular matrix is selected.

 *See Chapter 11, “Matrix and Personal Q Mixers.”*

Configuring Aux, Group, and Variable Group Busses

Auxes and Groups (or Variable Groups) share the available system busses. Configuration options include the following:

8 Auxes + 8 Stereo Groups Divides the available system busses between 8 mono Aux busses and 8 stereo Group busses.

16 Auxes + 8 Mono Groups Divides the available system busses between 16 mono Aux busses and 8 mono Group busses.

16 Auxes + 8 Variable Groups (24 Bus) Divides the available system busses between 16 mono Aux busses and 8 mono Variable Group busses (enables Variable Groups mode).

 *Audio may be interrupted or may change levels during this configuration procedure*

To configure the Aux/Group/Variable Group busses:

- 1 Put the system into Config mode.
- 2 Go to the Options page and click the System tab.
- 3 Click Edit.
- 4 Select a bus configuration.

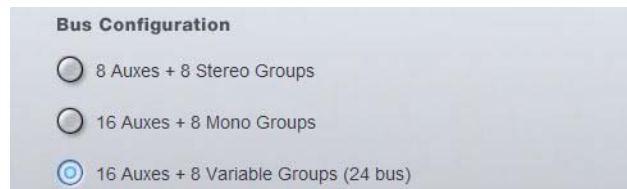

Selecting a bus configuration

- 5 Click Apply. The system restarts with the new bus configuration.

Data Cleared When Changing Bus Configurations

When the bus configuration is changed, all settings are cleared (or set to default) from the current console settings and from all stored snapshots, for all Groups.

Linking Aux Busses

You can link odd/even bus pairs and pan input signals into those bus pairs. Aux bus pairs are linked on a global basis, and appear as linked on all channels. For information on linking Auxes, see “Linking Aux and Variable Group Busses for Stereo Operation” on page 93.

Naming Channels

Output channel names can be changed from the Outputs page or from the Patchbay.

To change the name of an Output channel:

- 1 Go to the Outputs page or the Patchbay page.
- 2 Target the channel whose name you want to change by pressing its Select switch or selecting it on-screen.
- 3 Double-click the channel name.



Changing the name of an Output channel in the Outputs page

- 4 Type a new name and press Enter on the computer keyboard.

 *When naming channels in the Patchbay, double-click the channel name next to the grid to edit text; press Tab on the keyboard to go to the next channel and Shift+Tab to go to the previous channel.*

Assigning Busses to Hardware Outputs

Mains, Groups (or Variable Groups), Auxes, Matrix mixer outputs and PQ mixer outputs can be assigned to any hardware output on the system. Available output destinations include:

- Stage audio outputs
- FOH (local) audio outputs
- Pro Tools recording inputs

To assign a bus or mixer output to a hardware output from the Patchbay:

- 1 Go to the Patchbay page and click the Outputs tab.
- 2 To the left of the channel grid, click the Mains, PQ, Mtx (Matrix), Aux or Grp (Groups) tab.
- 3 Click in the channel grid to assign a bus or Matrix/PQ mixer output (listed on the left) to a hardware output (listed across the top).



Assigning an output in the Patchbay Outputs page

The Patchbay Outputs page shows the name of the bus or mixer and its destination. The destination is also displayed below the channel name in the Outputs page and Patchbay Outputs page.



Output name and destination in the Patchbay Outputs page

Routing Group Outputs to the Mains Busses

You can route Group outputs to the Main busses from the console or on-screen.

To route a Group output to the Main busses from the ACS:

- 1 Press the Groups switch in the Output Fader assignment section to assign control of Group levels to the faders.

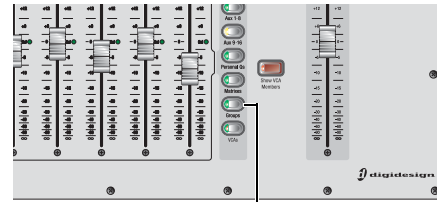

Groups switch

Assigning Groups to the Output faders

- 2 Select each Group that you want to assign to the Main busses by pressing their Select switches.
- 3 In the Bus Assigns section, press the L-R (left and right) or C/Mono (center/mono) switch so that it is lit.

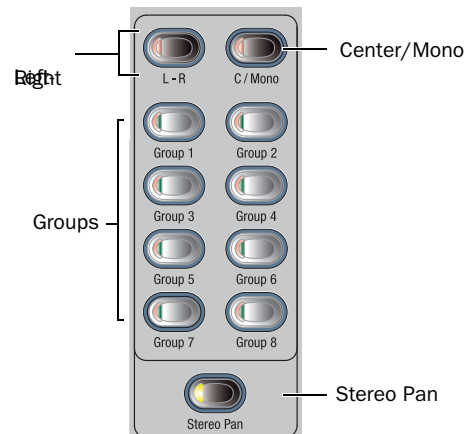

Bus Assign switches

- 4 Move the channel's fader to set the Group output level.

Group Routing Indication on Output Encoders

Output encoder indicator LEDs indicate Main bus assignments as follows:

Off Group routing to Mains is turned off.

Yellow Group output is routed to the Mains L-R bus.

Green Group output is routed to the Mains C/M bus.

Red Group output is routed to both the Mains L-R bus and the Mains C/M bus.

To route a Group output to the Main busses on-screen:

- 1 Go to the Outputs page and select the channel fader strip for the Group you want to route to the Main busses.
- 2 Click the Bus Assign buttons on-screen to toggle the bus assignment for the selected Group.



Assigning a Group output to the Main busses from the Output page

Using Inserts on Output Busses

You can use software plug-in inserts and graphic EQ on Mains, Groups (or Variable Groups), Auxes, Matrix mixers, and PQs.

Using Plug-In Inserts on Output Busses

You can insert plug-ins on Output busses directly from the Outputs page.

To insert a plug-in on an output bus:

- 1 Go to the Outputs page and target the bus where you want to insert the plug-in.
- 2 In the Inserts section of the Outputs page, do one of the following:
 - Click one of the four Inserts pop-up menus and choose a plug-in directly from one of the Plug-In Rack submenus.
 - or –
 - Click one of the four Inserts buttons to go to the Plug-In Rack, and route the signal to the plug-in using Plug-In Rack controls.

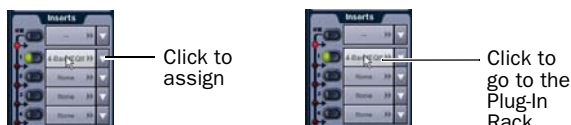

Assigning a Plug-In Insert in the Outputs page

The name of the plug-in insert appears in the on-screen Plug-In Insert button.

 For complete instructions on plug-ins, see Chapter 18, "Plug-Ins."

Using Hardware Inserts on Output Busses

You can insert external processors in the signal chain of Output busses. Signals from these sources are routed to and from analog or digital I/O connectors on the FOH Rack (or Mix Rack FOH I/O).

Assigning Hardware Inserts to Outputs

You can assign hardware inserts to Output busses directly from the Outputs page or from the Patchbay.

To assign a hardware insert to a bus:

- 1 Go to the Outputs page and target the bus where you want to assign the hardware insert.
- 2 In the Inserts section of the Outputs page, do one of the following:
 - Click the Hardware Insert pop-up menu and choose an insert destination directly from the menu.
 - or –
 - Click the Hardware Insert button to go to the Inserts page of the Patchbay, and assign the insert from the Patchbay.

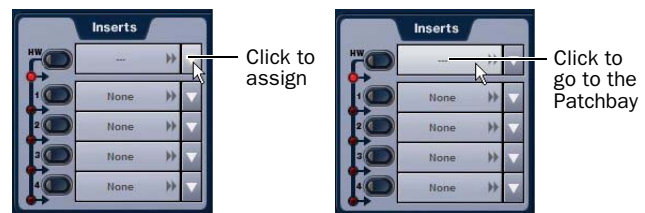

Assigning a hardware insert in the Outputs page

The name of the hardware insert destination appears in the on-screen Hardware Insert button.

Setting the Hardware Insert Location

You can choose the location of the hardware insert in the signal path, relative to the four plug-in inserts, for each channel. A hardware insert does not need to be currently assigned to do this.

To set the hardware insert location:

- 1 Go to the Outputs page and select the channel where you want to set the hardware insert location.
- 2 In the Inserts section of the Outputs page, click the hardware insert indicator so that it lights red.

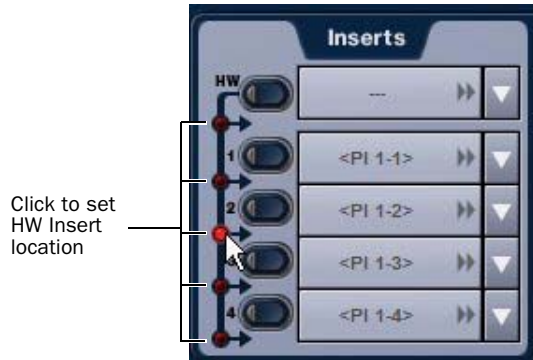

Setting a hardware insert location in the Inputs page

Activating and Bypassing Inserts

After plug-in inserts are assigned to an Output bus, they can be activated and bypassed from the ACS Inserts section of the console or on-screen using the Output page controls.

To activate or bypass an Output bus insert:

- 1 Target the bus by pressing its Select switch.
- 2 Press any of the Plug-In switches, or click the HW In/Out button on-screen. The switch lights when the Insert is activated.

Inserting the Built-In Graphic EQs on Output Busses

A built-in 31-band Graphic EQ can be inserted on any of the Output bus types. A maximum of 24 Graphic EQs are available, depending on how they are configured. For more information on configuring and using Graphic EQs, see “Graphic EQ for Outputs” on page 147.

To insert a Graphic EQ on an Output bus:

- 1 Target the bus by pressing its Select switch.
- 2 In the Outputs page, click the 31-Band Graphic Equalizer tab.
- 3 Click the Graphic EQ pop-up menu and choose an available mono or stereo Graphic EQ. The entire Graphic EQ is displayed on-screen.



Output bus selected (Group 1)

Graphic EQ displayed in the Outputs page

Adjusting Output Controls

Outputs are controlled from the Output faders, encoders and switches.

Output Levels

To control output levels from the Output faders:

1 Press one of the following switches in the Output Fader assignment section:

- Aux 1–8
- Aux 9–16
- Personal Qs
- Matrixes
- Groups
- VCA

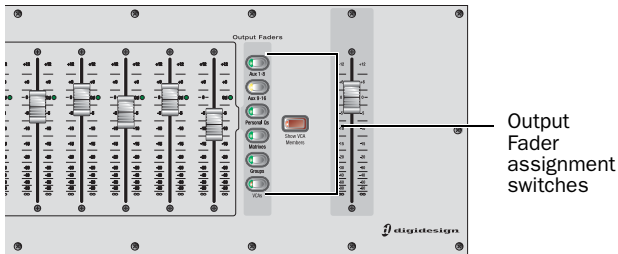

Output Fader controls

2 Move a fader to change the level of its assigned output.

To create a level offset between linked Aux bus or Variable Group bus output faders:

1 Press one of the following switches in the Output Fader assignment section:

- Aux 1–8
- Aux 9–16
- Groups (when in Variable Groups mode)

2 Do one of the following:

- Touch one linked bus output fader while moving the other.
- Hold the Start (Win) key on the keyboard and move one linked Aux bus fader on-screen.

The offset between the faders is maintained until the offset causes a fader to reach its maximum or minimum value.

To control Aux or Group output levels from the Assignable Output Encoders:

1 Press one of the following switches in the Output Encoder assignment section:

- Aux 1–8
- Aux 9–16
- Groups (assigns Variable Groups when in Variable Groups mode)

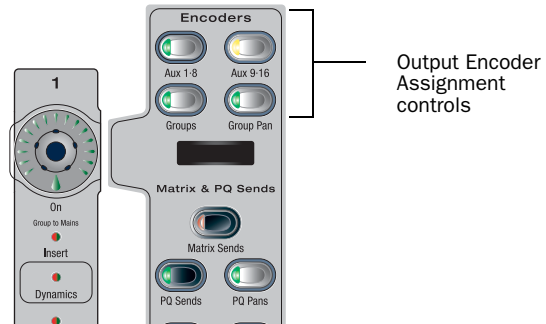

Assignable Output Encoders

2 Turn an encoder to change the level of its assigned output.

Output Polarity (Phase) Invert

The polarity of any output bus signal can be inverted. With stereo outputs (stereo Group busses) only the left channel is inverted.

To invert the polarity of an output bus:

1 Target the bus by pressing its Select switch.

2 Press the polarity inversion (\emptyset) switch in the ACS Input section. The switch lights when the polarity is inverted.

Output Solo

To control the solo status of an output bus:

1 Press one of the switches in the Output section.

2 In the Output section, press an AFL switch to toggle the solo status of the corresponding output bus.

 For more information on Solo bus operation, see Chapter 14, "Solo and Monitor Busses."

Output Mute

To control the mute status of an output bus:

- 1 Bank the Output faders to the desired type of output:
- 2 In the Output section, press a Mute switch to toggle the mute status of the corresponding output bus.

For more information on Mute operation, see Chapter 15, “Muting and Mute Groups.”

Output Delay

A variable delay can be applied to any of the Main busses (L, R and C/M), Aux bus outputs, and Matrix mixer outputs. (Variable Group outputs do not have this variable delay feature.)

To apply delay to an Aux bus:

- 1 Target the Aux bus by pressing its Select switch.
- 2 Press the ACS Delay rotary encoder to engage the delay.
- 3 Adjust the delay value by turning the Delay rotary encoder.

The amount of delay available depends on the type of output, as follows:

- Up to 500 ms for Mains and Matrix mixers
- Up to 250 ms for Aux Sends

Adjusting Main Bus Controls

Mains Bus Output Levels

The Mains bus output levels are controlled from the single Mains Fader located to the right of the Output faders.

The Left, Right, and Center/Mono busses can be controlled independently or in tandem. You can create an offset between any of the Main bus levels, and it will be preserved when controlling any combination of the Main busses. The offset between the busses is maintained until at least one of the busses is minimized or maximized.

Linking Mains

You can link any of the three Mains busses for grouped-control of level and mute.

To link or unlink control of Mains from the console:

- Press the Link switch (Left, Right, or Center/Mono) so that it remains lit for each bus you want linked. If a Link switch is off, that Mains bus will not be affected by the Mains fader or mute.

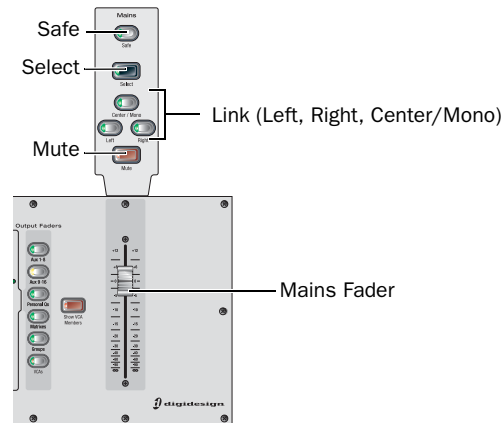

Mains Fader and controls in the Output section

To link control of the Mains on-screen:

- 1 In the Outputs page, click the on-screen channel Link buttons for any combination of Left, Right, or Center/Mono output strips to assign control of the corresponding busses to the Mains Fader.

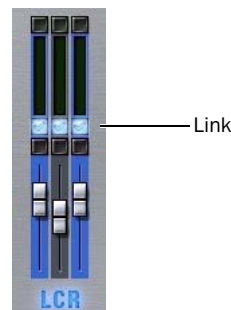

Mains fader Link selectors in the Outputs page

- 2 Move the Mains fader to change the level of the assigned busses.

Mains Bus Mute

The mute status of the Main busses is controlled from the Mute switch located above the Mains Fader. When at least one of the Main busses is muted while others (unlinked) are not, the Mains mute switch flashes.

To control the mute status of the Main busses:

- 1 In the Outputs page, click the on-screen channel Link buttons for any combination of Left, Right, or Center/Mono output strips to assign control of the corresponding busses to the Mains Fader.
- 2 Press the Mute switch to toggle the mute status of the assigned busses.

Mains Bus Delay

A variable delay (from 0 to 500 ms) can be applied to any of the Mains busses.

To apply delay to a Mains bus from the console:

- 1 Target a Mains bus where you want to apply delay by repeatedly press the Select switch in the Mains section (this cycles the through each of the Mains busses). You only have to select one linked bus to apply delay to all linked busses.
- 2 Press the ACS Delay encoder so that its indicator LED lights.
- 3 Adjust Delay by turning the Delay encoder.

To apply delay to Mains bus on-screen:

- 1 Target the bus by clicking its fader on-screen in the Outputs page.
- 2 Click the on-screen Delay In switch to enable delay on the selected bus.
- 3 Adjust the on-screen Delay encoder to the desired value.

Main Bus Center Divergence Options

When the Main busses are set to L–C–R (Left-Center-Right) mode, the Center Divergence setting determines amount of center-panned signal sent to the center output.

- ◆ When Center Divergence is set to 100%, a channel panned to center is sent to the center output only.
- ◆ When Center Divergence is set to 0%, a channel panned to center is sent equally to the left and right outputs only (phantom center).
- ◆ A Center Divergence setting between 0% and 100% sends a center-panned channel to the left, center, and right outputs with the center channel more prominent as the value increases towards 100%.

To set Center Divergence:

- 1 Go the Options > Busses tab.
- 2 In the Panning section, click in the Center Divergence field and drag up/down to increase/decrease the value (or type in a new value).
- 3 Press Enter or Return on your keyboard to confirm the setting.

Main Bus Automatic Delay Compensation

VENUE systems automatically compensate for delays incurred by the use of Groups and insertion of plug-ins in the signal path to the Main busses. Delays are automatically applied to signals arriving at the Main busses from multiple destinations to maintain the proper time alignment.

Monitoring the Mains Mix

You can send the Mains mix (the signal present on the Main busses) to the Monitor bus for routing to the monitor bus for headphones. See “Sending the Main Mix to the Monitor Bus” on page 125.

Direct Outputs

All input channels and output buses feature Direct Outputs.

Available destinations for Direct Outputs include:

- Stage Rack (or Mix Rack Stage) audio outputs
- FOH Rack (or Mix Rack FOH) audio outputs
- Pro Tools recording inputs
- Plug-ins

Each output destination may be fed by only one Direct Output signal (multiple Direct Output signals cannot be routed to a single output).

To route a channel or bus to a Direct Output:

- 1 Target the channel or bus you want to route to a Direct Output by pressing its Select switch.
- 2 In the Directs page of the Patchbay, click the tab for the channel or bus type you are routing.
- 3 Click in the channel grid to route the channel or bus (listed on the left) to an available output (listed across the top).



Assigning a Direct Output in the Patchbay Directs page

- 4 Select the pickoff point for the Direct Output by clicking the letter to the right of the channel or bus name and choosing from the pop-up menu.

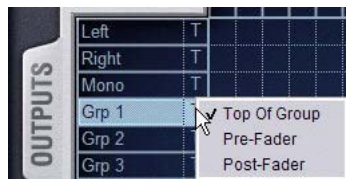

Selecting a Direct Output pickoff point in the Patchbay Directs page

- 5 In the ACS, press the Direct Output encoder so that its indicator LED stays lit (on).
- 6 Turn the Direct Out encoder to set the Direct Output level.

Up to 12 dB of gain can be added to the Direct Output signal. Direct Output level is displayed in the Selected Channel display, and controls are provided on-screen in the Patchbay, Inputs, and Outputs pages.

Direct Output Pickoff Points

The pickoff points for the Direct Output signal are selected in the Directs page of the Patchbay. The following pickoff points are available for each type of channel or bus:

Pickoffs for Direct Outs

Channel Type	Available Pickoff Points
Input	Top of channel Insert return Pre/post fader
FX Returns	Top of return Pre/post fader
Outputs	Top of bus Pre fader Post fader

Configuring Direct Output Pickoff Points

To configure the Direct Output pickoff point for Inputs:

- 1 Go to the Options page and click the Pickoffs tab.
- 2 Under Input Strip Fader Pickoff Point, click Pre-Fader or Post-Fader.

Matrix Mixers

Eight Matrix mixers are available for sending up to eight mono mixes of input channels and busses to any available hardware output or bus-fed plug-in.

Each Matrix is a 12-in/1-out mono mixer with assignable input sources including Group busses or Aux busses, the 3 Main busses (L-C-R or L-R+M) and any of up to 8 user-selectable channels. Matrix input levels are controlled from the Output encoders when a Matrix is selected. Adjacent Matrix inputs can be linked or unlinked.

Odd/even pairs of Matrix mixers can be linked to form stereo Matrix output busses. The master output of each Matrix mixer is controlled from the Output faders.

 See Chapter 11, "Matrix and Personal Q Mixers."

Personal Q Mixers

Eight Personal Q (PQ) mixers are available for sending up to eight discrete stereo mixes of input channels or busses to any available hardware output or bus-fed plug-in. Each PQ is a 12 x 2 mixer with assignable input sources including Group busses or Aux busses, the 3 Main busses (L-C-R or L-R+M) and any of up to 8 user-selectable channels.

Each of these PQ mixers can be remotely controllable by optional PQ Controller units, which allow adjustment of PQ mixer levels from the stage.

 *If no PQ Controllers are used, the PQ mixers are still available for use as stereo Matrix mixers at the console.*

PQ input levels and PQ input pan are controlled from the Output encoders. Adjacent PQ inputs can be linked or unlinked. The master output of each PQ mixer is controlled from the Output faders.

 *See Chapter 11, "Matrix and Personal Q Mixers."*

Assigning and Using VCAs

VCA controls emulate the operation of traditional Voltage Controlled Amplifiers (VCAs). Up to eight VCA faders are available for remote control of input channel, FX return, or output channel fader gain.

 *VCAs control level of the assigned channels only. They do not act as a summing output bus.*

VCAs remotely control the fader gain of each channel assigned to the VCA fader, but do not change the position of the faders on those channels. The accumulated gain of a channel belonging to several VCAs is limited to +12 dB.

Assigning Channels to VCAs

To assign channels to VCAs:

- 1 Press the VCAs switch in the Output faders section.
- 2 Select the VCA you want to target for assignment.
- 3 Press the Multi-Assign switch to the right of the Output section.
- 4 Press the Select switches on the input channels, FX returns, or output channels you want to assign to the VCA.
- 5 Press the flashing Multi-Assign switch to confirm the assignment, or press the Cancel switch to cancel the assignment.

Channel Strips Show VCA Contribution

The *effective gain* of any channel is equal to the combination of its individual channel fader, plus any (all) VCA level changes that affect that channel.

Input and output channels display the net effect of VCA level (effective gain) on-screen. This lets you keep track of what all currently assigned VCAs are doing to channels and busses at all times.

On-Screen VCA Indication

VENUE displays effective gain as a second, transparent fader cap on-screen in the fader displays of both the Inputs and Outputs pages.

Selected Channel When the currently selected channel is under VCA control, the net effect of all its assigned VCAs is shown in the form of a transparent fader cap.

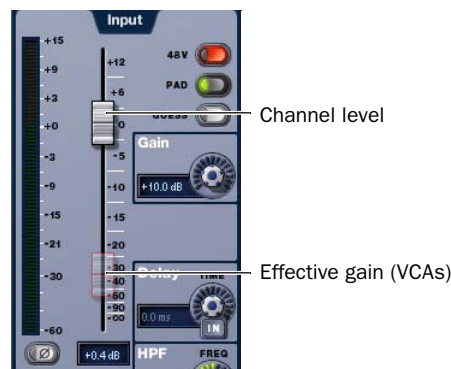

Effective gain (VCA contribution) shown on the selected channel

Inputs and Outputs Pages In the Inputs and Outputs pages, red "ghost" fader caps appear below the fader displays of channels that are currently assigned to one or more VCAs.



Effective gain (VCA contribution) shown in the on-screen fader displays

The opacity of the ghost caps vary with the actual VCA levels:

- Lighter caps indicate smaller amounts of VCA gain.
- Brighter caps indicate larger amounts of VCA gain.

Turning Channel VCA Indication On and Off

By default, channel VCA indication is on. You can turn off VCA indication in the Options > Interaction page.

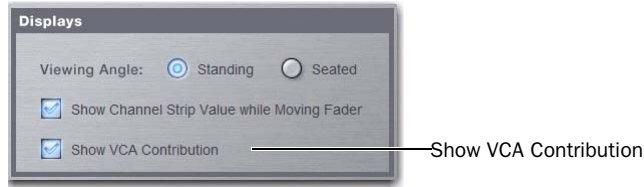

Displays settings in the Options > Interaction page.

To turn channel VCA indication off or on:

- 1 Go to the Options > Interaction page.
- 2 In the Displays section, click to enable (or disable) Show VCA Contribution.

Showing VCA Members

To view VCA membership:

- 1 Select a VCA by doing either of the following:
 - Press the VCA switch to bank the Output faders to VCAs, then press the Select switch on the desired VCA channel.
 - On-screen, go to the Outputs page and click to select the desired VCA. Channels assigned to the VCA are listed by name in the Members list.
- 2 To view VCA assignment on the console, press the Show Members switch.

VCA assignments are shown in each channel strip LCD with a flashing number (the number indicates the VCA to which each channel is assigned).

To exit Show VCA Members mode:

- Press the Multi Assign switch, or Cancel.

Using VCAs

To adjust the levels of VCA members:

- 1 Press the VCAs switch to assign control of the VCAs to the Output faders.
- 2 Move the fader for the VCA whose members you want to adjust.

To solo the members of a VCA:

- Press the Solo switch on the VCA channels whose members you want to solo so that the Solo switch is lit.

Input channel solo mode (PFL or AFL) follows the current setting on the Options > Busses page.

 *Input channel solo mode (PFL or AFL) follows the current setting on the Options > Buses page.*

To mute the members of a VCA:

- Press the Mute switch on the VCA channels whose members you want to mute. The Mute LEDs on channels assigned to the VCA flash to indicate they are implicitly muted by the VCA.

VCA Spill

You can “spill” a VCA to have only its assigned channels banked to the Input section. VCA Spill lets you quickly access only those channels assigned to a specific VCA and immediately focus on those channels, without needing to search through the input fader banks.

To spill a VCA:

- 1 Select the VCA output fader bank.
- 2 Double-press a VCA Select switch to spill its members across the input faders.

The selected VCA Select switch LED flashes, as do the current input Bank (A-D) or FX Return (1-8) switch. Any Bank Safed channels are hidden (though their Bank Safe status is unaltered).

If the VCA contains fewer than 16 members the channels are right-justified within the input fader bank, in order to bring channels as close as possible to the center of the console. Unused channel strips are left blank and inactive.

If the VCA contains more than 16 members, only the first 16 members are shown.

To cancel VCA Spill, do any of the following:

- Press or double-press the Select switch on the currently spilled VCA.
- Press any Bank (A-D) switch.
- Press the FX Returns 1-8 switch.
- Press a GEQ switch.
- In the on-screen dialog, click Exit VCA Spill.

Selecting Other VCAs While Spilled

Selecting another VCA while spill mode is active automatically spills that VCA.

Chapter 9: Groups

This chapter shows how to do the following:

- Configure Group busses
- Route Groups
- Adjust Group bus parameters

Configuring Group Busses

The Output section has 8 available Group busses. Group outputs can be assigned to the Main Output busses, to available bus-fed plug-ins, to Matrix and PQ mixers, and to any hardware outputs on the systems.

Group busses can be globally configured to be mono or stereo as part of the Aux/Group bus configuration. See “Configuring Aux, Group, and Variable Group Busses” on page 76.

Routing Inputs to Group Busses

To route multiple channels to a single Group:

- 1 Press the Groups switch to bank the Output faders to the Groups busses.
- 2 Press the Multi-Assign switch in the Output section for the desired Group. The Multi Assign and output Select switches flash.
- 3 Press the Select switch on the channels you want routed to the selected Group.
- 4 Press the Multi Assign switch again to confirm the action.
– or –
 - Select another Group to confirm the current assignment but remain in Multi Assign mode to assign channels to the newly targeted Group bus.

To route channels to any number of Group busses:

- 1 Target one or more channels.
- 2 In the Bus Assigns section of the ACS, press any of the Group switches so that they are lit.

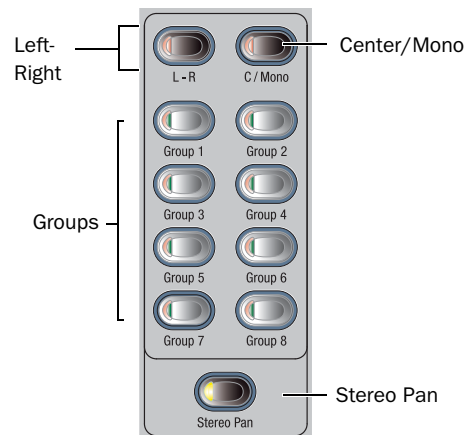

Bus Assign switches

Routing Group Outputs to the Main Busses

You can route Group outputs to the Main busses from the ACS or on-screen.

To route a Group output to Mains from the ACS:

- 1 Press the Groups switch in the Output Fader assignment section to assign control of Group levels to the faders.
- 2 Select each Group that you want to assign to the Main busses by pressing their Select switches.
- 3 In the ACS Bus Assigns section, press the L-R (left and right) or C/Mono (center/mono) switch so that it is lit.

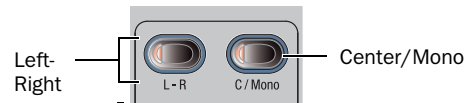

Bus Assign switches

To route a Group output to the Main busses on-screen:

- 1 Go to the Outputs page and select the Group you want to route to the Main busses.
- 2 Click the Bus Assign buttons on-screen to toggle the bus assignment for the selected Group.



Assigning a Group output to the Main busses from the Output page

Managing Group Bus Assignments

To help manage Groups, the following sections explain how you can spill, view, copy (duplicate) and reset Groups and Group bus assignments.

Group Spill

You can “spill” a Group to have only its assigned channels banked to the Input section. Group Spill lets you quickly access only those channels assigned to a specific Group and immediately focus on those channels, without needing to search through the input fader banks.

To spill a Group:

- 1 Select the Group output fader bank.
- 2 Double-press a Group Select switch to spill its members across the input faders.

The selected Group Select switch LED flashes, as do the current input Bank or FX Return switch. Any Bank Safed channels are hidden (though their Bank Safe status is unaltered).

If the Group contains fewer than 16 members the channels are right-justified within the input fader bank, in order to bring channels as close as possible to the center of the console. Unused channel strips are left blank and inactive.

If the Group contains more than 16 members only the first 16 members are shown.

To cancel Group Spill, do any of the following:

- Press or double-press the Select switch on the currently spilled Group.
- Press any Bank (A-D) switch.
- Press the FX Returns 1-8 switch.
- Press a GEQ switch.
- In the on-screen dialog, click Exit Group Spill.

Selecting Other Groups While Spilled

Selecting another Group while spill mode is active automatically spills that Group.

Special Cases with Spill

Faders

If you are touching a fader at the same time as you invoke Group Spill, that fader may be taken off-line. Let go of the fader to bring it back online.

Viewing Group Bus Assignments

You can view Group bus assignments from the Input section of the console or from an on-screen list of Group members.

Viewing Group Bus Assignments in the Input Section

The channel Bus Assign LEDs 1–8 in each input strip light to indicate that channel’s current Group assignments. The Stereo Pan LED lights when at least one bus is being fed as a stereo-linked pair or in true stereo.

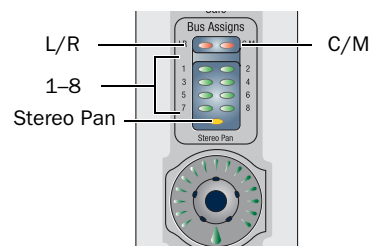

Input channel Bus Assign LEDs

Viewing Group Bus Assignments On-Screen

When a Group bus channel is targeted on-screen, its members are shown in a list on the right side of the Outputs page.

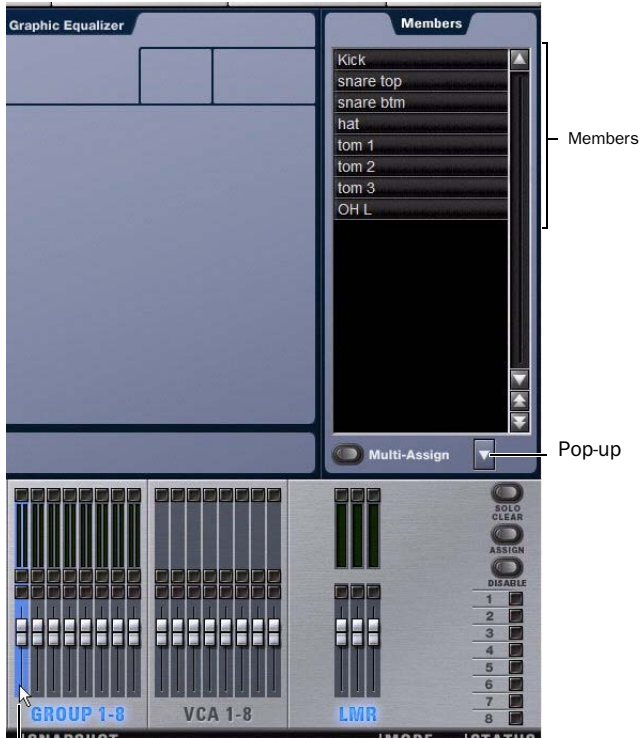

Currently selected output (Group)

Group members shown in the Outputs page

Copying Assignments Between Groups

You can copy the current input assignments from one Group bus to another. If the Groups are stereo, assignments can be copied from other linked busses. This lets you quickly duplicate monitor mixes.

⚠ Copying Group bus assignments overwrites all the assignments on the destination Group bus.

To copy input assignments between Group busses:

1 Target the Group bus that you want to be the destination of the copied assignments by selecting its on-screen channel strip.

2 Click the Input Assign pop-up menu at the bottom of the Members list, choose Replace With Mix From, then choose the Group whose assignments you want to copy to the currently selected bus.

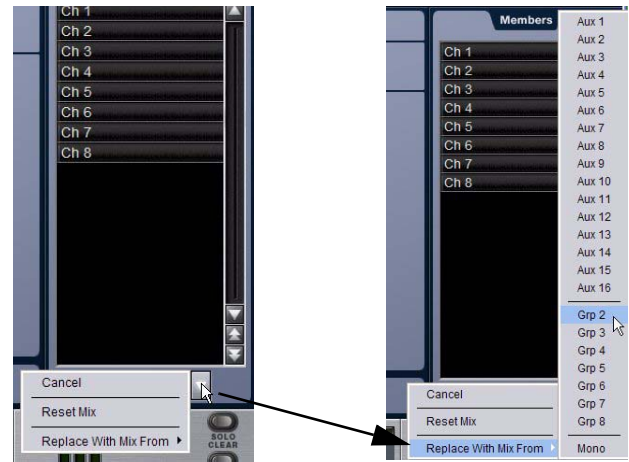

Copying input assignments between Groups

Resetting Group Bus Assignments

You can remove input assignments from a Group on-screen.

To remove an input assignment from a Group bus:

1 Select the Group bus you want to change so that its members are displayed on-screen.

2 In the list of Group bus members, right-click the input assignment you want to remove and choose Unassign.

To remove all input assignments from a Group bus:

1 Select the Group bus you want to change so that its members are displayed on-screen.

2 Click the pop-up menu at the bottom of the Members list and choose Reset Mix.



Removing input assignments from a Group bus

Group Bus Signal Flow Options

Routing Signals to a Mono Group Bus Configuration

When configured as mono busses, the eight Groups can be fed as 8 unlinked mono busses or up to 4 linked odd/even bus pairs.

Unlinked Mono Busses

To use unlinked mono Group busses:

- 1 Make sure the Group busses are configured as mono busses. See “Configuring Aux, Group, and Variable Group Busses” on page 76.
- 2 While routing channels to Group busses, make sure the Stereo Pan switch is off.

The Group switches in the ACS Bus Assigns section light green to indicate mono operation. In this configuration, input signals are handled as follows:

Mono Input Signals Contributing mono signals are summed to the mono Group bus. Any pan information from mono input channels feeding the bus is ignored.

Stereo Input Signals Contributing stereo signals are summed to the mono Group bus with no attenuation. The balance and width information from each stereo input channel is ignored.

Linked Odd/Even Bus Pairs

To use linked mono Group bus pairs:

- 1 Make sure the Group busses are configured as mono busses. See “Configuring Aux, Group, and Variable Group Busses” on page 76.
- 2 While routing channels to Group busses, press the Stereo Pan switch so that it lights yellow.

The Group switches in the ACS Bus Assigns section and the Stereo Pan LED in the channel’s Bus Assign indicator light yellow to indicate stereo operation. In this configuration, input signals are handled as follows:

Mono Input Signals Contributing mono signals are panned across the linked odd/even Group bus pair. Pan information from each mono input channel determines its pan position in the bus pair.

Stereo Input Signals Contributing stereo signals are panned across the linked odd/even Group bus pair. Balance and width information from each stereo input channel determines its contribution to the odd and even sides of the bus pair.

Routing Signals to a Stereo Group Bus Configuration

When configured as stereo busses, the eight Groups can be fed as 8 true stereo busses or (in Expert mode only) as 8 dual mono busses.

Stereo Busses

To use stereo Group busses:

- 1 Make sure the Group busses are configured as stereo busses. See “Configuring Aux, Group, and Variable Group Busses” on page 76.
- 2 When routing channels to any of the Group busses, make sure the Stereo Pan switch is lit yellow.



When working with stereo Groups in Simple Mode, the Stereo Pan switch is always lit to indicate all Groups operate in true stereo.

Dual Mono Busses

Dual mono busses may only be used in Expert Mode. See “Simple and Expert Operational Modes” on page 91.

Adjusting Group Bus Output Controls

Group Bus Output Levels

Group bus levels are adjusted just like other Output busses (bank to Groups, adjust the fader). For more information, see “Adjusting Output Controls” on page 80.

Group Bus Output Pan

Group bus output pan is controlled from the Output encoders.

Groups-to-Mains assignment is displayed by the indicator LED for each Output encoder, when Groups are banked to the Output faders. The Output encoder Pan switch cycles the encoders and LCD to pan, balance and width parameters.

The pan controls adjust pan (when in mono Groups configuration) or stereo balance and width (when in stereo Groups configuration) of the Group output to the Main busses only. The Group outputs in the Patchbay are distinct left and right channels.

To control mono Group output pan:

- 1 Bank the Output faders to Groups.
- 2 Press the Pan switch in the Output encoder section once to assign control of Group pan to the Output encoders.
- 3 Turn a rotary encoder to adjust the pan for the corresponding mono Group.

To control stereo Group output balance and width:

- 1 Press the Pan switch in the Output encoder section.
- 2 Turn a rotary encoder to adjust the balance for the corresponding stereo Group.
- 3 Press the Group Pan switch in the Output Encoder assignment section an additional time to assign Group width control to the Output encoders.
- 4 Turn a rotary encoder to adjust the width for the corresponding stereo Group.

Simple and Expert Operational Modes

When configuring Group busses, you can choose between two operational modes that provide different levels of flexibility: *Simple mode* and *Expert mode*.

Setting the Operational Mode

To switch between Simple mode and Expert mode:

- 1 Put the system in Config mode.
- 2 Go to the Options page and click the Busses tab.
- 3 Under Stereo Group Panning Operation, select the mode you want to use (Simple or Expert).



Setting the Group bus operational mode

Working with Mono Group Busses

When configured as mono busses, Groups can operate in the following modes:

Simple Mode

In Simple mode, either all Groups on a channel are mono, or all Groups on a channel act as bus pairs.

Expert Mode

In Expert mode, any of the 4 bus pairs can be stereo linked individually while leaving the other busses as mono, on a per channel basis.

To set the link status of individual mono Group busses on a channel (Expert Mode only):

- 1 Make sure Stereo Group Panning is set to Expert Mode.
- 2 Select an input channel or FX return whose signal you want to send to a Group bus. To select multiple channels, use the Multi-Select switch next to the input faders.
- 3 In the Bus Assigns section, press the Stereo Pan switch. The switch flashes yellow to indicate bus link mode.
- 4 Press any of the Group switches to link or unlink the bus pairs (1–2, 3–4, 5–6, or 7–8). The Group switch pairs flash yellow to indicate stereo linked, or flash green to indicate mono.
- 5 Press the flashing Stereo Pan switch to confirm the bus link status for the selected channels.

Working with Stereo Group Busses

When configured as stereo busses, Groups can operate in the following modes:

Simple Mode In Simple Mode, all 8 Group busses function only as true stereo busses.

Expert Mode In Expert Mode, any of the 8 stereo Group busses can be set to act as true stereo or as dual mono busses, on a per channel basis.

To set the link status of individual stereo Group busses for a channel (Expert Mode only):

- 1 Make sure Stereo Group Panning is set to Expert Mode.
- 2 Select an input channel or FX return whose signal you want to route to a Group bus. To select multiple channels, use the Multi-Select switch next to the input faders.
- 3 In the ACS Bus Assigns section, press the Stereo Pan switch. The switch flashes yellow to indicate bus link mode.
- 4 Press any of the Group switches (1–8) to set the corresponding bus to stereo or dual mono. The Group switches flash yellow to indicate stereo, or flash green to indicate dual mono.
- 5 Press the flashing Stereo Pan switch to confirm the bus link status for the selected channels.

To use dual mono Group busses (Expert Mode only):

- 1 Make sure the Group busses are configured as stereo busses. See "Configuring Aux, Group, and Variable Group Busses" on page 76.
- 2 Make sure the link status of the Group busses you want to use is set to dual mono.

When routing channels to a dual mono Group bus, the Stereo Pan switch will be off and the Group switch will light green to indicate dual mono operation.

Chapter 10: Aux Sends and Variable Groups

This chapter explains the following Aux Sends operations:

- Configuring Aux Send busses
- Routing to Aux Sends
- Adjusting Aux Send parameters
- Managing Auxes

Configuring Aux and Variable Group Busses

Up to 16 Aux busses are available. The number of available Aux busses is set as part of the overall Aux/Group bus configuration. (See “Configuring Aux, Group, and Variable Group Busses” on page 76.)

When the system is set to Variable Groups mode, the 8 Group busses are replaced by *Variable Group* busses, which operate in much the same way as Aux busses. When set to Variable Groups mode (Var Groups), the 16 Aux and 8 Variable Group busses provide up to 24 busses.

Auxes can be mono, or linked to form stereo pairs. Auxes and Variable Group busses can be fed by input channels and FX returns, and can be assigned to hardware outputs in the Patchbay. Aux Send level controls provide a gain range of $-INF$ to $+12$ dB.

Linking Aux and Variable Group Busses for Stereo Operation

When working with Aux/Var Group busses, you can link odd/even bus pairs and pan input signals into those bus pairs.

To link Aux or Var Group bus pairs:

- 1 Put the system into Config mode.
- 2 Go to the Options page and click the Busses tab.

- 3 Click *Edit*.



Linking bus pairs in the Options > Busses page

- 4 Click the checkboxes above any of the bus pairs to link or unlink each pair.

- 5 Click Apply.

When busses are linked, signals are handled as follows:

Mono Input Signals Contributing mono signals are panned across the linked odd/even bus pair.

- When the Follows Channel Pan option is off, panning of the mono signal to the bus pair is controlled by the Aux Pan control (the even-numbered send).
- When the Follows Channel Pan option is on, the pan information from each mono input channel determines its pan position in the bus pair.

Stereo Input Signals Contributing stereo signals are panned across the linked odd/even bus pair. Stereo width information from the input channel is applied to the bus signal.

- When the Follows Channel Pan option is off, balance of the stereo signal to the bus pair is controlled by the Aux Pan control.
- When the Follows Channel Pan option is on, the balance from each stereo input channel determines its contribution to the odd and even sides of the bus pair.

Selecting Aux Send and Variable Group Pickoff Points

You can specify the pickoff point on input channels and FX returns channels for Aux and Var Group sends. Pickoff points are set for each bus independently. If any busses are linked, the pickoff point is set for the linked bus pair.

Each channel can be sent to an Aux or Var Group either pre- or post-fader. Pre-fade offers several choices of pickoff.

Pre-EQ Post-HPF and pre-EQ, Dynamics and Channel Inserts, pre-Mute, and pre-Fader. The Aux or Var Group send is not affected by the channel mute.

Pre-Mute Post-HPF, post-EQ, Dynamics, and Channel Inserts, pre-Mute, and pre-Fader. The Aux or Var Group send is not affected by the channel mute.

Pre-Fader Post-HPF, post-EQ Dynamics, and Channel Inserts, post-Mute, and pre-Fader. The Aux or Var Group send is affected by the channel mute.

To set the Pre pickoff point for an Aux or Variable Group send:

- 1 Go to the Options page and click the Busses tab.

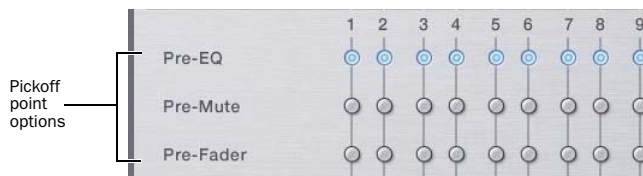

Setting Aux bus pickoff points

- 2 Select a Pre pickoff point for any of the busses or linked bus pairs by clicking the Pre-EQ, Pre-Mute, or Pre-Fader button.

To activate a Pre pickoff point for an Aux or Variable Group send:

- 1 Go to the Inputs page and target the channel with the pickoff point you want to activate.
- 2 Do any of the following:
 - To activate an Aux Send Pre pickoff, click the corresponding Pre button in the Aux Sends section.
 - or –
 - To activate a Variable Group Pre pickoff, click the Var Groups button in the Bus Assign section to display Var Groups, then click the corresponding Pre button.



Activating Pre pickoff for an Aux Send (Inputs page shown)

When the Pre button is lit, the selected Pre pickoff point is used. When the Pre button is off, the pickoff point is Post-Fader.

Classifying Auxes for Snapshots

You can classify Aux Sends and Variable Group sends as *monitor sends* (“Mon”) or as *effects sends* (“FX”) for the purposes of scoping and safing each type separately in snapshots. See “Classifying Aux Sends” on page 200.

Routing Inputs to Aux Busses

You can send signals from any input channel or FX return to any number of Aux Send or Variable Group busses with the input encoders, from the ACS, from the Output section, or on-screen.

To route channels to Aux or Var Group sends using the input encoders:

- 1 Do either of the following:
 - To access Aux Sends on the input channel encoders, press an Encoder assign Aux 1•2 through Aux 15•16 switch.
 - or –
 - To access Variable Groups, press the Stereo Pan switch in the ACS Bus Assigns section. This displays Variable Group Sends on the input encoders and the ACS Aux Send controls.

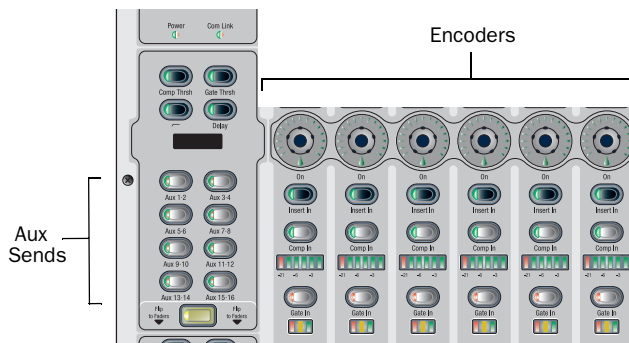

Aux assignment switches for input encoders

- 2 For each channel you want to assign to the selected Aux bus, press its channel encoder so that its “On” indicator LED lights.
 - The first press of an Aux Send encoder assigns level control of the odd-numbered send. The switch lights green to indicate an odd-numbered selection.
 - The second press of an Aux Send encoder assigns level control of the even-numbered send. The switch lights yellow to indicate an even-numbered selection.
- 3 To set the Aux Send level, do either of the following:
 - Turn the encoder on each channel.
 - Press the Flip to Faders switch, then adjust the channel fader.

To route channels to Aux Sends busses using the ACS:

- 1 Do either of the following:
 - To select a single channel, press its Select switch.
 - To select multiple channels, press Select on the first channel, hold the Multi-Select switch (located to the left of the input faders), then press the Select switches on the other channels.
- 2 In the ACS Aux Sends section, press an encoder to enable that send.
- 3 Rotate the encoder to adjust that send level.

To route channels to Aux Sends from the Output section:

- 1 Press the Auxes 1–8 or 9–16 switch to bank the Output faders to those Aux busses.
- 2 Press the Multi-Assign switch for the desired Aux. The Multi Assign and output Select switches flash.
- 3 Press the Select switch on the channels you want routed to the selected Aux Send.
- 4 Press the Multi Assign switch again to confirm the action.
– or –
 - Select another Aux Send to confirm the current assignment but remain in Multi Assign mode to assign channels to the newly targeted Aux bus.

Routing Aux Busses to Outputs and Plug-Ins

Aux and Var Group busses can be routed to hardware outputs and to available bus-fed plug-ins.

To route an Aux or Variable Group output to Mains from the ACS:

- 1 Press an Auxes switch (1-8 or 9-16) in the Output section to assign control of Aux levels to the Output faders.
- 2 Select each Aux that you want to assign to the Main busses by pressing their Select switches.
- 3 In the ACS Bus Assigns section, press the L-R (left and right) or C/Mono (center/mono) switch so that it is lit.
- 4 Move the channel's fader to set the Aux output level.

Like other Output busses, Aux busses also provide Direct Outs, inserts and built-in Graphic EQ capabilities. For details, see the following:

Direct Outs See “Direct Outputs” on page 83.

Inserts See “Using Inserts on Output Busses” on page 78.

Graphic EQ See “Inserting the Built-In Graphic EQs on Output Busses” on page 79.

Adjusting Aux Send Controls

You can adjust Aux Sends from the input encoders, from the ACS, and on-screen.

Using the Input Encoders

To control Auxes using the input encoders:

- Press an Encoder Assign switch Aux 1•2 through 15•16 to bank those Auxes to the input encoders.

To turn a send on or off:

- 1 Press the input encoder for the Aux on the desired channel to toggle that send on/off.
- 2 To adjust send level, turn that encoder.

When Aux busses are linked, input signals are panned across the bus pair. Panning can be controlled from the Input encoders or from the ACS Aux Sends section.

Controlling Aux Send and Variable Group Send Pan

When Aux busses or Variable Group busses are linked, input signals are panned across the bus pair. Panning can be controlled from the Input encoders or from the ACS Aux Sends section.

To control panning of Aux bus or Variable Group bus pairs from the Input section:

- 1 Do one of the following:
 - Press an Encoder assign Aux switch to bank that Aux to the input encoders.
 - Press the Stereo Pan switch in the ACS Bus Assign section to bank Variable Groups on the input channels.
- 2 In the Input Encoder Assignment section, press the Aux switch Aux 1•2 through 15•16 for the bus pair you want to pan.
 - The first press of the Aux switch assigns control of the send level to the encoder. The switch lights green and the encoder display shows the odd-numbered send.
 - The second press of the Aux switch assigns control of the send pan to the encoder. The switch lights yellow and the display shows a “P” before the odd-numbered send.
- 3 With the Aux switch lit, turn the rotary encoder on each Input Channel or FX Return to adjust the send pan.

To control panning of Aux bus or Variable Group bus pairs from the ACS Aux Sends section:

- 1 Bank the Output faders to the Aux 1–8 or Aux 9–16 (for Auxes) or Groups (for Variable Groups).
- 1 Target the bus you want to pan by pressing its Select switch. In a linked bus pair, the ACS Aux Send controls show the following:
 - Odd-numbered rotary encoders control send level
 - Even-numbered rotary encoders control send pan
- 2 Turn the even-numbered rotary encoders in the Aux Sends section to adjust the corresponding send pan.

 You can link the ACS Aux Sends section to follow AFL, letting you immediately access send controls for Auxes and Variable Groups by soloing any Aux or Group output strip. For more information, see “Auxes/Variable Groups Follow AFL and AFL Follows Auxes/Variable Groups” on page 122.

Using Flip to Faders to Access Send Level and Pan Simultaneously

You can use Flip to Faders mode to spill Aux or Variable Group level control to the input faders while retaining control of Send pan from the input encoders.

To access Send level and pan simultaneously:

- 1 Assign the input encoders to Aux Sends or Variable Groups by doing either of the following:
 - Press a Send switch in the Input Encoder Assignment section to assign the encoders to control level for the selected send.
 - Target an Aux or Variable Group bus by selecting it in the Output section.
- 2 Press the Flip to Faders switch, at the bottom of the Input Encoder Assignment section. The input faders now control and display level for the selected send, and the encoders display and control Send pan.

Setting Aux Send Pan to Follow Channel Pan

Panning of the input signal can be set to follow the pan or balance values of the Input Channel or FX Return feeding the Aux bus

To set the Aux Send pan to follow Channel pan:

- 1 Go to the Options page and click the Busses tab.
- 2 On any linked bus pairs, select the Follows Channel Pan option. This setting is applied globally to the corresponding Aux Send.

Managing Aux Bus Assignments

Viewing Aux and Variable Group Bus Assignments

When an Aux bus or Var Group output channel is targeted on-screen, its members are shown in a list on the right side of the Outputs page.

To view input assignments to an Aux or Variable Group bus:

- 1 Go to the Outputs page.
- 2 Target an Aux bus output channel by selecting its on-screen channel fader strip. Input channels routed to the selected bus are displayed in the Members list on the right side of the page.

To go to any assigned input channel from the Outputs page:

- Click the name of the input channel in the Members list.



Aux bus assignments shown in the Outputs page

Resetting Aux and Variable Group Bus Assignments

You can remove input assignments from Aux/Var Group bus output channels on-screen.

To remove an input assignment from an Aux or Variable Group bus:

- 1 Target the bus output channel you want to change by selecting its on-screen channel strip.
- 2 In the list of member input channel assignments, right-click the input assignment to remove and choose Unassign.

To remove all input assignments from a bus:

- 1 Target the Aux bus output channel you want to change by selecting its on-screen channel strip.
- 2 Click the pop-up menu at the bottom of the Members list and choose Reset Mix.

Copying Assignments Between Busses

You can copy the current input assignments from one Aux or Variable Group bus (or Mains) to another bus of either type. If the busses are linked, assignments can be copied from other linked busses. This lets you quickly duplicate monitor mixes.

⚠ *Copying bus assignments overwrites all the assignments on the destination Aux bus.*

To copy input assignments between busses:

- 1 Target the Aux bus that you want to be the destination of the copied assignments by selecting its on-screen channel strip.
- 2 Click the Input Assign pop-up menu at the bottom of the Members list, choose Replace With Mix From, then choose the Aux/Var Group bus whose assignments you want to copy to the currently selected bus.

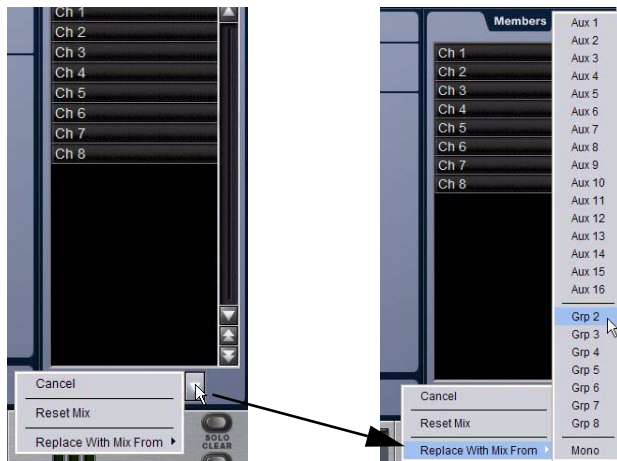

Copying input assignments between Aux busses

Copying Mains Assignments to Aux Busses

You can copy the current Main bus assignments to Aux busses or Variable Group busses to base monitor mixes from a main mix. Assignments to the Main Left/ Right busses can be copied to linked busses, and assignments to the Center/Mono bus can be copied to mono busses.

To copy bus assignments from the Mains to Auxes or Variable Groups:

- 1 Target the bus that you want to be the destination of the copied assignments by selecting its on-screen channel strip.
- 2 Click the Input Assign pop-up menu at the bottom of the Members list, choose Replace With Mix From, then choose the available Main bus (Left-Right or Mono) whose assignments you want to copy to the currently selected bus.

The state of the bus controls follow the state of the corresponding controls on the input channels assigned to the Mains: Channel Mute maps to Bus Send, Channel Pan maps to Bus Pan, and Channel Fader level maps to Bus Send level.

Chapter 11: Matrix and Personal Q Mixers

The Outputs section offers 8 mono Matrix mixers and 8 stereo Personal Q (PQ) mixers for setting up alternate mixes, fill and delay feeds, and cue, monitor or press mixes.

Matrix Mixers

Each of the 8 available Matrix mixers can receive up to 12 channels of input. Input sources can be any combination of Auxes, Groups or Mains busses, or any of the eight available Matrix User Sends. By default, each Matrix mixer has a mono output, but outputs can be linked to form stereo pairs.

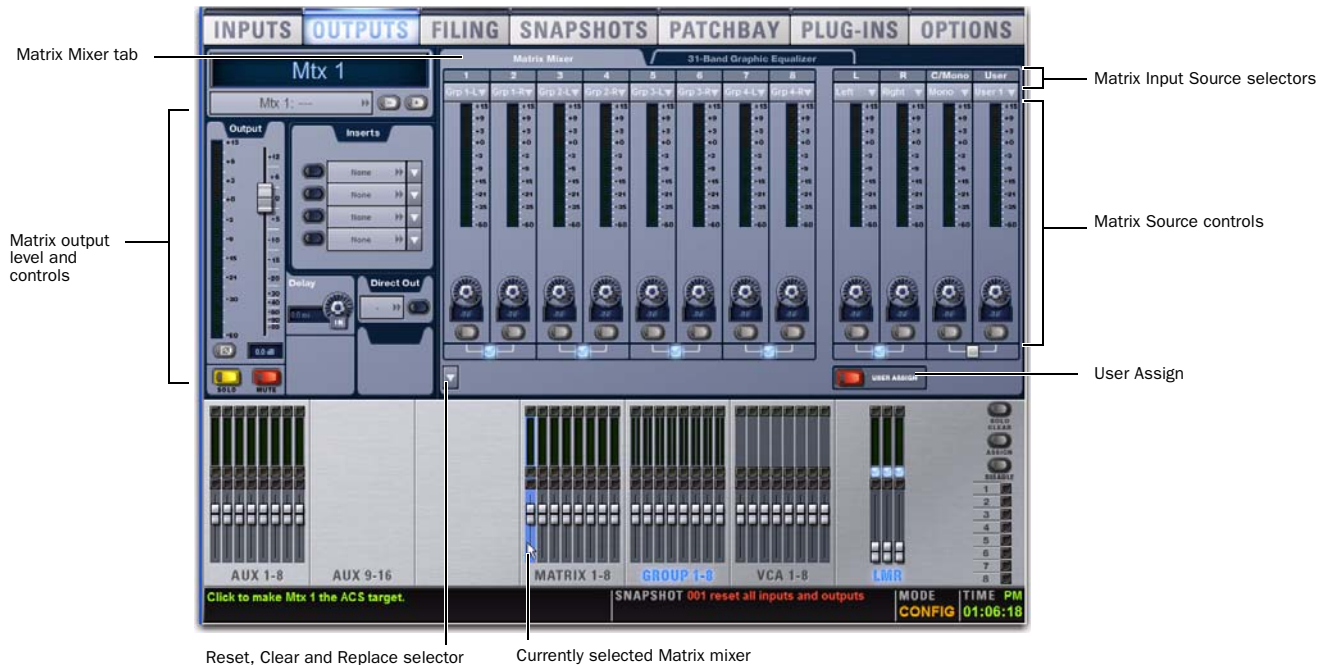

Matrix Mixer in Outputs page

Personal Q Mixers

Each of the 8 available Personal Q (“PQ”) mixers can receive up to 12 channels of input. Input sources can be any combination of Auxes, Groups or Mains busses, or any of the eight available PQ User Sends. Each Personal Q mixer has a stereo output.

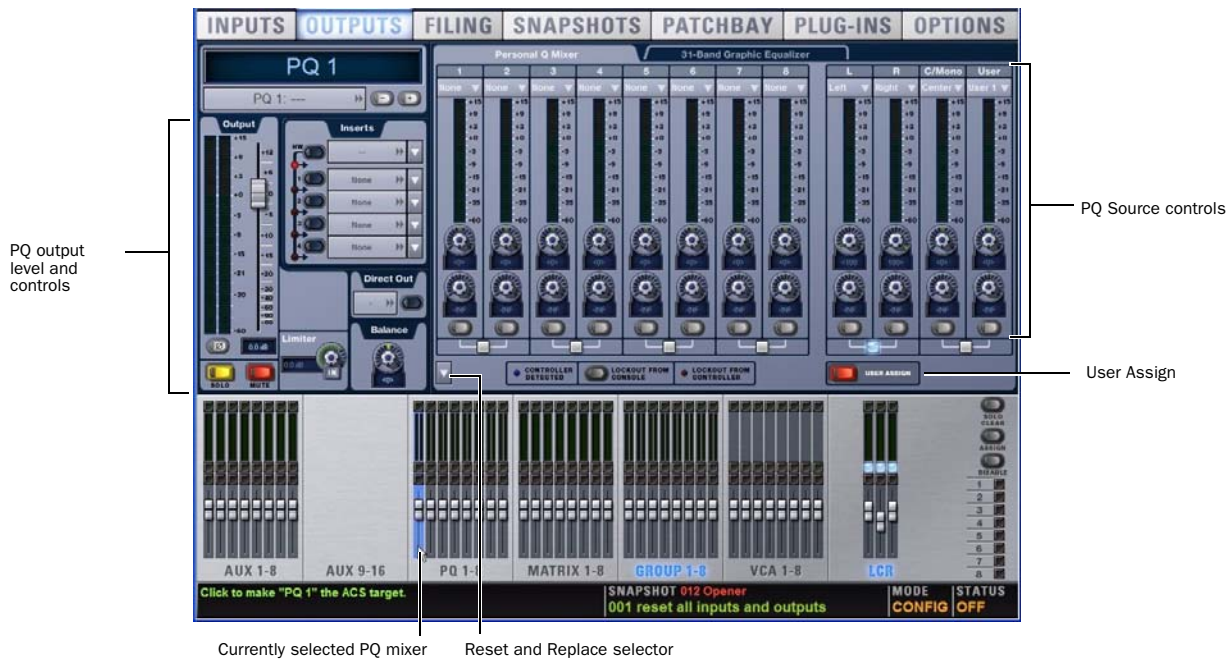

Personal Q Mixer in Outputs page

Personal Q Controller System (Optional)

With the optional Personal Q Controller system, performers can adjust the controls in the Personal Q mixer from a remote location. See the *VENUE Personal Q Guide* for details.

💡 *If no PQ Controllers are used, the PQ mixers are still available for use as stereo Matrix mixers controllable from the console.*

Configuring Matrix and PQ Mixers

The 12 Inputs for each Matrix and PQ mixer can be any combination of these 35 potential sources:

- 24 shared Aux and Group sources
- 3 Mains sources (LCR or LR+M)
- 8 User Input sources

User Inputs can be input channels, FX Returns, physical stage audio or FOH audio inputs, or inputs from Pro Tools playback options. In addition:

- One or more of the 8 available user inputs can be sent to one or more Matrix or PQ mixers.
- Input source assignment and user input assignment can be stored on a per-snapshot basis.
- The input sources for Matrix and PQ mixers are configured as Pre- or Post-Fader in the Pickoffs tab of the Options page.
- Input labels (1–8, Left, Right, C/Mono and User) are only intended as a guide. In use, any input source can be assigned to any mixer input (for example, Left doesn't always have to be assigned to the Left input of a mixer).

Configuring Aux, Group and Mains Pickoffs

To configure Auxes, Groups, and Mains pickoffs for the Matrix and PQ mixers:

- 1 Put the system in Config mode.

 *Configuring pickoff points may cause a momentary loss of audio, and therefore cannot be changed in Show mode.*

- 2 Go to the Options page and click the Pickoffs tab.
- 3 Under Matrix and PQ Sources, configure Aux, Groups and Mains (LCR or LR+M) as pre- or post-fader.

Linking and Unlinking Pairs to form Stereo Matrix Outputs

The eight mono Matrix mixers can be linked in odd/even pairs to form up to four stereo-linked pairs of matrix outputs. A combination of mono and stereo-linked Matrix mixers is possible. Odd-even matrix pairs are linked and unlinked using on-screen controls in the Options > Busses page.

 *Linking Matrixes is accomplished using the same Edit and Apply methods used for stereo linking Auxes.*

To stereo link Matrixes:

- 1 Put the system into Config mode.
- 2 Go to the Options > Busses page.
- 3 In the Matrix section, click Edit.
- 4 Click to enable the Link between any two adjacent (odd/even) Matrixes.
- 5 Click Apply. (Click Cancel to exit Edit mode without changes.)



Editing the link status of a Matrix pair in the Options > Busses page.

When a matrix pair is linked, the even-numbered channel inherits all parameter settings of the odd-numbered channel.

The matrix mixer changes to a stereo matrix mixer:

- A Pan control is added to each matrix mixer input source.
- All input sources are panned center upon linking.

Plug-in assignments to the formerly mono matrix channels are lost, including all snapshot references.

Unlinking Matrixes

To unlink a pair of Matrixes:

- 1 Put the system into Config mode.
- 2 Go to the Options > Busses page.
- 3 Click *Edit* in the Matrix section.
- 4 Click to unlink the desired Matrixes.
- 5 Click Apply.

When a Matrix pair is unlinked the even-numbered channel again inherits all parameter settings of the odd-numbered channel.

Pre-existing plug-in and GEQ routing may be affected when the matrix link state is changed. An alert dialog warning of data loss is shown prior to performing the link or unlink operation. Click OK to complete the link operation, or click Cancel to cancel without changes.

Snapshots

All matrix settings, including Pan but excluding the stereo link status, are stored and recalled with snapshots. The stereo link status of Matrix masters is not snapshottable.

Compatibility

Show files created in previous versions of software preserve all mono matrix settings in working memory and snapshots. Loading a Show file containing stereo-linked Matrixes in a previous version of software preserves all data except Matrix master link status.

Settings

You can copy and paste settings between mono and stereo Matrixes, and use the Replace with Mix command, by right-clicking on the Matrix and choosing Copy, Paste, or Replace with Mix from the menu.

Copy and Paste

Copy/paste only applies to master strip settings (fader, mute, polarity, delay, direct out). Mix parameters and mix sources are handled separately.

Replace

You can use the right-click menu to Replace mixer settings between mono and stereo Matrixes.

From	To	Result
Mono	Mono	All mix parameters and mix sources applied
Mono	Stereo	All mix parameters and mix sources applied; Pans default to center
Stereo	Stereo	All mix parameters and mix sources applied
Stereo	Mono	All mix parameters and mix sources except pan applied

Linking and Unlinking Adjacent Matrix Inputs

Adjacent inputs to Matrix mixers can be linked or unlinked on a per input pair basis. Link status can be specified on a per Matrix basis (for example, inputs 1 and 2 can be linked for Matrix 1, but unlinked for Matrix 2). This gives you the ability to control inputs as either a stereo-linked pair or as independent mono inputs.

- When linked, level and source on/off controls are linked.
- When unlinked, discrete level and on/off controls affect each individual channel.

Stereo inputs (such as stereo groups, Mains LR, and stereo-linked auxes) are linked by default, such as after a Clear Console operation. Adjacent inputs can be linked or unlinked at any time, in Config or Show mode.

To link or unlink inputs to Matrix mixers:

- 1 Go to the Outputs page, and click to display the Matrix mixer.
- 2 Click the checkboxes below any adjacent inputs to link or unlink them. A check mark in the checkbox indicates a linked input source; an empty checkbox indicates unlinked sources.



Link controls in the Outputs page

Relinking and Offsets

When inputs are relinked, their level and on/off state will change as follows:

Level Each channel maintains any offset between the two channels. This offset is not maintained if both linked controls are adjusted beyond their maximum or minimum.

On/Off Each channel maintains its discrete on/off state at the time the sources are relinked. For example, if one channel is on and the other is off the stereo input will maintain these settings after relinking, thus providing a stereo source with one channel on, and the other off. Toggling one channel from Off to On results in both channels switching On; toggling one of the linked channels from On to Off results in both channels switching Off.

Configuring User Inputs

You can assign up to eight User Inputs to be available globally to the Matrix mixers and, separately, up to eight User Inputs to be available globally to the PQ mixers.

Any of the eight User Inputs defined for the Matrix or PQ can be assigned to any mixer input. User Inputs are assigned from the User Assign panel of the Matrix or PQ main page.

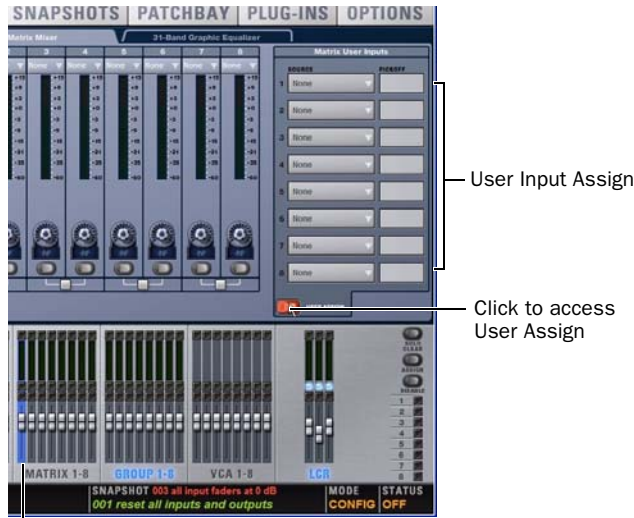

Currently selected Matrix mixer

User Input panel showing assignments for a Matrix mixer

To configure the User Inputs for a Matrix or PQ mixer:

- 1 Go to the Outputs page and click a Matrix or PQ mixer to navigate to that mixer page.
- 2 Click the User Assign button to display the User Assign panel.
- 3 For any of the eight available User Inputs, click the on-screen Source pop-up menu and select an available source. Choices include Channels, FX Returns, Stage and FOH audio sources, and Pro Tools record/playback options (if any).

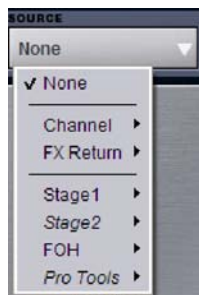

Choosing a User Assign source for a Matrix mixer

- 4 For any assigned User Inputs, click the Pickoff pop-up menu and choose the desired pickoff for that User Input source. Choices include Top of Channel, Insert Return, and Pre/Post-Fader (for Input Channels) or Top of FX Return and Pre/Post-Fader (for FX Returns).

 *The Input Channel Fader Pickoff setting on the Options > Pickoffs page determines globally whether the fader pickoff points are pre- or post-fader.*

- 5 Click the User Assign button again to return to the main Matrix screen.

Assigning Input Sources

To assign input sources to a Matrix or PQ mixer:

- 1 Go to the Outputs page and click to select a Matrix or PQ mixer.
- 2 Click the Input Source selector at the top of each Matrix or PQ channel and select the desired input source. Choices include Auxes, Groups, Mains and any of the 8 available User Inputs.

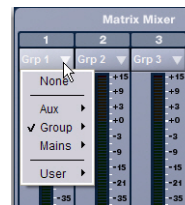

Choosing an Input Source for a mixer

 *To use Input or FX Return channels in a Matrix or PQ mixer, assign them as User Inputs, then assign those User Inputs as input sources.*

Assigning Sources to Multiple Mixers

You can select multiple Matrix and/or PQ mixers simultaneously and assign sources to all selected mixers at the same time.

To assign input sources to more than one Matrix mixer, or more than one PQ mixer, at a time:

- 1 Go to the Outputs page and use Multi-Select (or the Shift key) to select two or more Matrix mixers, or two or more PQ mixers, in the fader display at the bottom of the screen.
- 2 Click the Source selector at the top of a mixer channel (1–8, Left, Right, C/Mono, or User) and select the desired source.

Adjusting Matrix and PQ Mixer Input Controls

Matrix and PQ Mixer Input Levels

Input levels for Matrix and PQ mixers are controlled as follows:

- The levels for the first 8 input sources (or “sends”) of a Matrix or PQ mixer are controlled by the Assignable Output Encoders.
- The levels for the Mains inputs of a Matrix or PQ mixer are controlled by the encoders marked *Left Send*, *Center Send*, and *Right Send*.
- The level for the user-selected input is controlled by the encoder marked *User Send*.

To control mixer input source (“send”) levels:

1 Press the Matrix Sends switch or the PQ Sends switch in the Output Encoder assignment section.

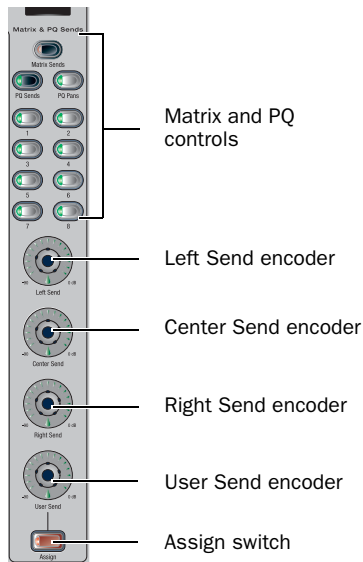

Matrix and PQ mixer controls

2 Press any of the numbered Send switches (1–8) to assign the corresponding Matrix mixer or PQ mixer to the Assignable Output Encoders and mixer Send encoders.

3 For each of the mixer input sources you want to activate, press the encoder knob so that its “On” indicator LED lights.

4 Do any of the following:

- Turn the rotary encoders 1–8 to adjust any of the first eight input sources.
- Turn the Left Send, Center Send, or Right Send encoders to adjust any of the Mains bus feeds to the selected Matrix or PQ mixer.
- Turn the User Send encoders to set the level for the corresponding User Send mixer input.

Matrix and PQ Mixer Input Pan

The Matrix and PQ mixer input pan controls adjust the panning of each mixer input across the stereo outputs of either a linked stereo Matrix mixer or PQ mixer (PQ mixers are always stereo).

To control Matrix send pan:

1 Press the Matrixes switch in the Output fader assign section. The Output fader LCDs turn yellow to indicate stereo-linked Matrixes.

2 Press the Matrix Sends switch to toggle the Output Encoders between its default mode (input or “send” level) and Matrix Pan. When in Pan mode, the LCD displays MTXPAN, and the Matrix Sends switch flashes.

3 Adjust the Output Encoder 1–8 to adjust pan on Matrix inputs 1–8. Adjust the Left Send, Center Send, or Right Send encoders, or the User Send encoder, to set the pan position of the corresponding mixer input.

4 To access inputs 9–12 for the current mixer, press the Next Page switch.

To control PQ send pan:

1 Press the PQ Pans switch in the Output Encoder assignment section.

2 Press any of the numbered Send switches (1–8) to assign the corresponding PQ 1–8 mixer to the Assignable Output Encoders and mixer Send encoders.

3 Turn the rotary encoder knobs 1–8 and the Left Send, Center Send, Right Send, and User Send encoders to set the pan position of the corresponding mixer input.

Resetting Matrix and PQ Mixer Input Controls

You can reset level, pan and stereo link settings for any Matrix or PQ mixer. Input source assignments persist.

To reset a Matrix or PQ mixer parameter to its default value:

- 1 Select one or more Matrix or PQ mixers you want to change.
- 2 Right-click the encoder on-screen and choose Reset.

To reset all Matrix or PQ mixer parameters to their default values:

- 1 Select one or more Matrix or PQ mixers you want to change.
- 2 Click the pop-up menu at the bottom of the mixer area and choose Reset Mix.



Resetting a mix

Clearing Matrix and PQ Mixer Settings

You can clear mixer input assignments to quickly set all the input sources to None.

To clear Matrix or PQ input assignments:

- 1 Select one or more Matrix or PQ mixers you want to clear.
- 2 Click the pop-up menu at the bottom of the mixer area and choose Clear Mix Sources.

Copying Matrix and PQ Mixer Input Settings

You can copy mixer settings from one Matrix or PQ mixer to another mixer of the same type. This lets you quickly duplicate monitor mixes or other signal feeds.

 *Copying mixer settings overwrites all the settings on the destination mixer.*

To copy settings between mixers:

- 1 Select the Matrix or PQ mixer that you want to be the destination of the copied settings so that it is displayed on-screen.
- 2 Click the pop-up menu at the bottom of the mixer area, choose Replace With Mix and Mix Sources From.
- 3 Choose the Mtx (Matrix mixer) or PQ from the sub-menu whose settings you want to copy to the current mixer.

Adjusting Matrix and PQ Mixer Output Controls

Matrix and PQ Mixer Output Levels

Matrix and PQ output levels are controlled by the Output faders.

To control mixer output levels:

- 1 Press the Matrixes or PQ switch to bank Matrix or PQ mixers to the Output faders.
- 2 Adjust the fader corresponding to the output level you want to change.

PQ Mixer Output Limiter

A limiter can be applied to the output of PQ mixers. PQ output limiter controls appear on-screen only. (Matrix mixers do not have output limiters.)

To use a limiter on the output of a PQ mixer:

- 1 Go to the Outputs page.
- 2 Select a PQ channel to display the mixer you want to configure.
- 3 Click the on-screen Limiter In button to engage the limiter.
- 4 Drag the on-screen Limiter knob to set the limiter threshold.

Stereo-Linked Matrix and PQ Mixer Output Balance

PQ Mixers and stereo-linked Matrix mixers provide a balance control for controlling the balance of the mixer output signal across its stereo outputs. (Mono Matrix mixers have mono outputs, so they do not have Balance controls.)

Use the on-screen Balance encoder in the Outputs page of all Matrix or PQ mixers if you need to balance levels.

To control Matrix or PQ mixer output balance:

- 1 Target the stereo-linked Matrix or PQ mixer output channel by pressing its Select switch in the Output Faders section.
- 2 Turn the Pan rotary encoder at the lower left of the ACS to adjust balance for the currently selected mixer output.
 - or –
 - Click and adjust the on-screen Balance encoder in the Outputs page for the currently selected mixer.

Matrix Mixer Output Delay

A variable delay (0–500 ms) can be applied to the output of Matrix mixers. For instructions, see “Output Delay” on page 81.

Delay Compensation with Matrix and PQ Mixers

VENUE automatically compensates for the delay offsets that can arise when combining different signal paths within a Matrix or PQ mixer.

Additional Information about Delay Compensation

- The overall latency through a Matrix or PQ mixer is determined by the path with the highest latency.
- All inputs within a Matrix or PQ mix are guaranteed to be phase accurate, but mixes are not necessarily aligned to each other. This ensures that all mixes are not penalized in the case of one or more exceptionally high-latency signal paths.
- Delay compensation only accounts for a channel's post-insert pickoff. Channels that feed User Inputs and Auxes (pre-insert) will not be fully compensated for.

 See also “Settings for Delay Compensation” on page 55.

Snapshot Data and Parameters for Matrix Mixers

Snapshots can store and recall all source assignments of each Matrix and PQ mixer when the MTX (Matrix) or PQ data type is scoped. In addition, all User Input assignments are stored, letting you reconfigure Matrix or PQ mixers and User Input assignments on a per snapshot basis, if desired.

The following table describes what can be stored and recalled in each snapshot when the MTX and PQ data type is scoped.

Table 12. Snapshot data types and parameters for Matrix and PQ

Snapshot Data Type	Included Parameters (for Each Scoped Channel Strip)
MTX	Mixer Input Sources, User Input Assignments (global to all Matrixes), and pickoffs; Mixer Input level, Mixer Input on/off state and Mixer <i>Input</i> Link state
PQ	Mixer Input Sources, User Input Assignments (global to all PQs) and pickoffs; Mixer input level, pan, and on/off state, Mixer Input Link state, Limiter threshold and Limiter in/out

 *You cannot snapshot link state of Matrix outputs.*

The Recall Safe tab of the Snapshots page provides two data “Mix” data types that let you discretely “safe” source and/or user input assignments to prevent them from being changed with a snapshot recall.

For complete information on VENUE snapshots, see Chapter 21, “Snapshots.”

Working with a PQ Controller

When an optional Personal Q remote control system is connected to a VENUE system, it can be used to adjust the controls in the Personal Q mixers from a remote location.

For complete instructions on connecting and using PQ Controllers, refer to the *Personal Q Controller Guide*, included with the PQ Controller system.

Controller Detection

When a PQ Controller is detected, the Controller Detected indicator lights in the corresponding Personal Q mixer on-screen window.



PQ Controller Detected indicator in PQ mixer

Controller Lockout

Lockout From Console The PQ Controller can be locked out by clicking the on-screen Lockout From Console button in any of the PQ mixers. When this Lockout button is engaged, the PQ Controller cannot adjust PQ mixer controls. The performer using the PQ Controller cannot override this lockout from the controller.

Lockout From Controller Users can lock their PQ Controllers to prevent inadvertent changes to controller settings. When this is done, the on-screen Lockout From Controller indicator lights in the corresponding PQ mixer. This function does not lock out control of the PQ mixer from the console.

Calling the Console Operator from the PQ Controller

To call the console operator from a Personal Q Controller:

- Press the Master Volume encoder knob.

A call message appears on the console display that identifies which PQ Controller is calling. The Call LED on the PQ Controller flashes until the message is cleared from the console display.

Chapter 12: Patchbay

Accessing the Patchbay

To show the Patchbay screen:

- Press the Patchbay switch, located in the View Modes section, or click the Patchbay tab on-screen.

To jump to the Patchbay from the Inputs and Outputs screens:

- Click on the channel routing indicator, right below the channel name display. The screen automatically jumps to the corresponding Patchbay screen (whether an input, output, or bus).



Jump to Patchbay

Overview of the Patchbay

The Patchbay screen lets you patch hardware I/O to input and output channels.

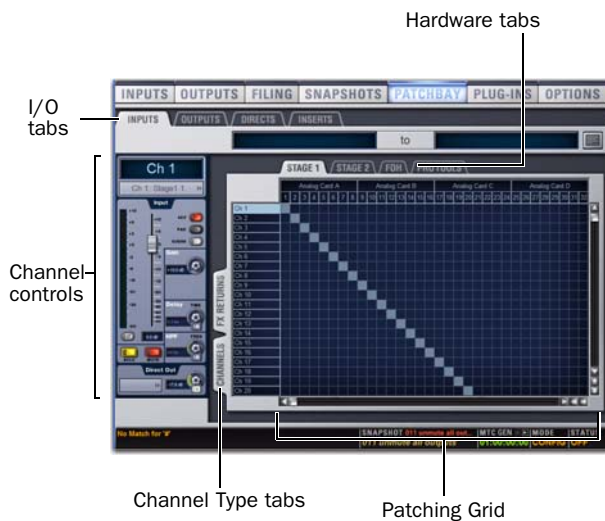

Patchbay page (Inputs tab shown)

The main tools and sections of the Patchbay screen are the following:

Tabs

The Patchbay is navigated using the following tabs.

I/O Tabs

Click to display and patch Inputs, Outputs, or Directs (Direct Outputs). Other options in the Patchbay screen change to reflect the currently selected I/O tab.

Channel Type Tabs

Click these tabs to select and display specific types of channels, as available for the currently selected I/O. The following table shows the available Channel Types for the current I/O.

I/O tab	Channel Types available
Inputs	Channels, FX Returns
Outputs	Groups, Auxes, Matrix, PQ, Mains
Directs	Channels, FX Returns, Outputs
Inserts	Channels, FX Returns, Outputs

Hardware Tabs

Click these tabs to display the hardware inputs and outputs available for the current I/O and Channel Type. These represent the physical inputs and outputs of the system.

Choices include Stage audio inputs and outputs (Mix Rack or Stage Rack), FOH (local) inputs and outputs (Mix Rack or FOH Rack), and Pro Tools playback/record option inputs and outputs, if any. Available hardware inputs and outputs are based on channel type selection, system configuration and hardware device status. See “Unavailable I/O” on page 108.

Patching Grid

The Patching Grid shows hardware I/O across the top, and VENUE channels down the left side. The available channel tabs and choices are determined by the currently selected I/O tab and Channel type(s). The grid squares represent patch points between hardware I/O and VENUE mixing channels.

By default, hardware inputs are routed in a 1-to-1 pattern to input channels. For example, Stage Rack inputs 1–48 appear on Input Channels 1–16 (Bank A), 17–32 (Bank B) and so on.

Channel Controls

These controls mirror the controls for the currently selected channel. For example, when showing Inputs, the Channel controls let you adjust input gain, polarity, phantom power, HPF, Direct Out, and basic level without leaving the Patchbay.

Channel Direct Outs

The channel area in the Patchbay provides access to Direct Out controls.

To adjust Direct Output level from the Patchbay:

- 1 In the Patching Grid, patch the channel Direct Out to an available output.
- 2 In the channel controls, adjust the on-screen Direct Output encoder.



Adjusting Direct Output level from the Patchbay

Visual Indicators and Displays

The Patchbay uses the following visual conventions in all its pages and tabs.

Unavailable I/O

The Patchbay shows hardware tabs for all possible configurations. The Patchbay indicates I/O that is offline or unavailable by graying out the columns beneath that device.

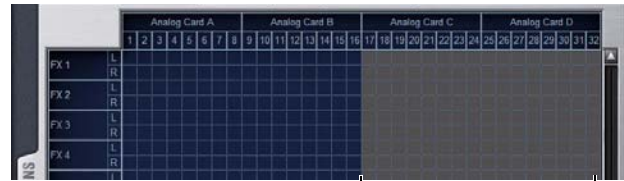

Unavailable I/O

Unavailable I/O (grayed columns)

Unavailable hardware I/O appear grayed out in the patchbay and italicized in all routing pop-up lists. It is possible to make assignments to unavailable hardware I/O.

Assigned I/O

When a hardware connection is assigned, its connection is dimmed in all Patchbay screens. This lets you see which hardware connections are in use without having to switch back and forth between Patchbay screens. You can also use the dimmed column number indicator to jump to the Patchbay tab for the existing assignment (for more information, see “Shortcut for Locating Assignments” on page 111).

Text Display of Patch Source and Destination

Above the grid tabs are “from” and “to” text display fields that display the full text names of hardware I/O and channels.

To view full names of a patch source and destination:

- Place the cursor over a Channel Name.

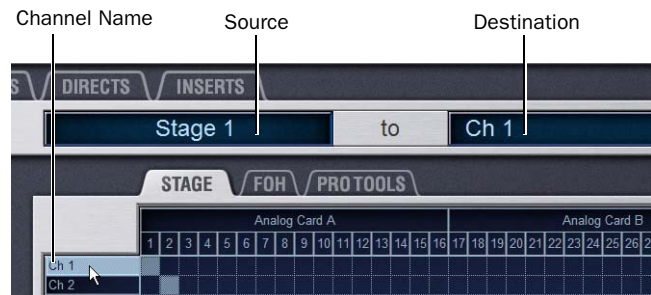

Channel source and destination display

If the channel is already routed, its source and destination assignments appear directly above the Patching Grid. An asterisk at the end of a destination name indicates a multiple output assignment. See “Multiple Input and Output Assignments in the Patchbay” on page 110.

Naming Channels from the Patchbay

Channel names can be changed from the Patchbay. Channel names can be up to 32 characters in length. When displayed on the console, names are abbreviated to fit the display.

To name or rename a channel from the Patchbay:

- 1 Double-click the channel name.
- 2 Type a new name and press Enter on your keyboard.

 When naming channels in the Patchbay, press Tab on the keyboard to go to the next channel and Shift+Tab to go to the previous channel.

Type Text Search

Type Text search lets you use the keyboard for fast navigation to a channel. You can enter the first characters of a channel name or the absolute channel number to target that channel on the ACS.

To search for and select a channel:

- 1 Type the first few letters, full name, or channel number of the channel. For example, type “s” to go to the first channel beginning with the letter s (such as *Snare*).
- 2 Press the Tab key to cycle through and select any other channels beginning with that letter (such as *Snare Top*, *Snare Bottom*, or *Strings*).

 Avoid giving channels names that begin with numbers different from the absolute channel number. When you type a number, VENUE navigates to absolute channel numbers regardless of the channel name.

Navigating the Patchbay

Navigating to Channel Types

The Patchbay uses multiple tabs to access different hardware I/O and channel types. For example, the Inputs screen provides Channels and FX Returns tabs for you to patch these different channel types independently.

Examples

To show Inputs:

- Go to the Patchbay page and click the Inputs tab.

To show a specific type of Input in the Patching grid:

- In the Patchbay page, click the Channels tab, or the FX Returns tab. Shift-Click to select and show multiple types at once.

To navigate to a different hardware source:

- Click the appropriate Hardware tab across the top of the Patching Grid.

Scrolling in the Patchbay

To scroll through the channel list (vertically):

- Move the cursor over a channel name at the left of the Patching Grid, then press the Up or Down Arrow keys on the keyboard.

To scroll through the hardware I/O list (horizontally):

- Move the cursor over a hardware I/O channel at the top of the Patching Grid, then press the Left or Right Arrow keys on the keyboard.

To scroll the Patching Grid, do one of the following:

- Click the up/down or left/right Patching Grid scroll arrows to move square by square.
- Click the up or down Patching Grid double arrows to move screen by screen.
- Right-click in the Patching Grid and drag in any direction.



Scrolling the Patching Grid by right-clicking and dragging

Assigning Channels in the Patchbay

To assign channels in the Patchbay:

- 1 Go to a Patchbay page by clicking the appropriate I/O tab, Channel Type tab, and Hardware tab.
- 2 Place the cursor over the Patching Grid. The cursor changes to a crosshair, and lines extend above and to the left of the cursor location to identify the column and row.
- 3 Click in the row for the channel and in the column for the hardware I/O source.



Routing a hardware input to an Input Channel

- 4 Click and drag vertically, horizontally, or at an angle to assign multiple patch points in a single action.
- 5 Repeat as needed.

Patchbay Click and Drag

You can quickly select a range of crosspoints in the Patchbay grid in one operation with a left-click and drag of the cursor. You can click and drag horizontally, vertically, and at 45-degree angles in any direction.

⚠ You cannot undo changes to the Patchbay grid.

To use click and drag in the Patchbay grid:

- 1 Left-click on the crosspoint defining the start of the range.
- 2 Continue to hold the left-click button, then drag horizontally (to populate a row), vertically (to populate a column), or horizontally and vertically (a 45-degree angle).
- 3 Release the left-click button when the destination crosspoint is reached. All crosspoints along the path are filled in.

The destination crosspoint sets the targeted channel. If the new assignments steal any previous assignments, a warning dialog will ask you to confirm or cancel the reassignment.

SHIFT To suppress the reassignment warning dialog, hold **Default** (on the control surface) or **Alt** (on the computer keyboard) while clicking in the patch grid. For more information, see “Warning when Stealing Inputs or Outputs in the Patchbay” on page 111.

Using the Arrow Keys to Assign Channels

You can use the Arrow keys to assign routing.

To assign channels using the Arrow Keys on the keyboard:

- 1 Place the cursor over the Patching Grid so that the cursor changes to the crosshair.
- 2 Press the Left or Right Arrow keys to move the crosshair to the next or previous hardware I/O column; press the Down or Up Arrow keys to move the cursor to the next or previous channel.
- 3 When the crosshair is over the correct square in the grid, press Enter to assign the patch.

Multiple Input and Output Assignments in the Patchbay

Input sources can be assigned to multiple Input Channels in the Patchbay. Output busses can be assigned to multiple hardware outputs.

Stage inputs assigned to multiple channels share a common preamp gain. Adjusting one channel's gain automatically adjusts all other channels. All other channel functions (such as EQ, dynamics, and panning) remain independent, making it convenient to have a channel appear on one input strip to bus and process it for the house mix, and on another input strip for monitor mixing.

To assign a hardware input source to multiple Input Channels or FX Returns:

- 1 Go to the appropriate Input tab in the Patchbay.
- 2 Click in the Patching Grid to assign the source to the first Input Channel or FX Return.
- 3 Click additional grid squares in the same column to assign the source to additional channels. The selected hardware input is routed to each of the assigned Input Channels or FX Returns.

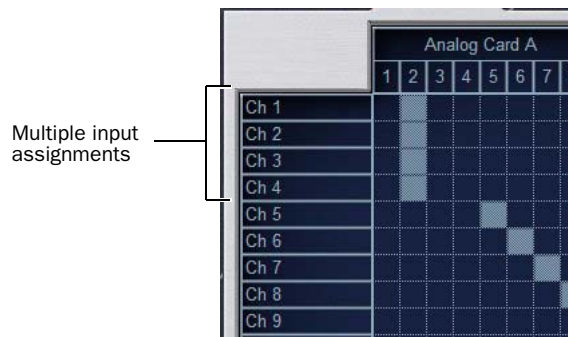

A hardware input routed to multiple Input Channels

To assign an Output bus to multiple hardware outputs:

- 1 Go to the appropriate Output tab in the Patchbay.
- 2 Click in the Patching Grid to assign the Output bus to the first hardware output.
- 3 Click additional grid squares in the same row to assign the same Output bus to additional hardware outputs. An asterisk (*) appears at the end of the displayed destination to indicate the multiple routing.

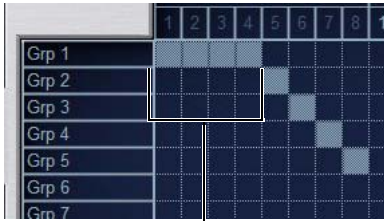

Multiple output assignments

An Output bus assigned to multiple hardware outputs

Choosing the Digital Source (AES or ADAT)

If your system includes a DSI digital input card, do the following to specify the digital source.

To configure a digital input for AES or ADAT:

- 1 In the Patchbay, route a DSI or other digital input to an input channel.
- 2 Click the Inputs tab and navigate to the input channel being fed from the DSI input.
- 3 Click the ADAT button on-screen, in the channel Input controls section. When lit, ADAT input is active; when unlit, AES input is active. The corresponding channel's Source LED on the Stage Rack DSI Card lights to indicate AES or ADAT.

Warning when Stealing Inputs or Outputs in the Patchbay

The Patchbay indicates hardware outputs that are already in use by dimming the column number for that physical output. In addition, a dialog is shown if the patch will steal a hardware input *or* output that is already in use, asking you to confirm or cancel the reassignment.

To confirm a reassignment, do one of the following:

- Click Assign when prompted to confirm the reassignment.
– or –
- Click again on the same patch point.

To cancel a reassignment, do either of the following:

- Click Cancel to leave the patchpoint unchanged.
- Click any other point in the grid (the Patchbay grid remains active, even when the Confirm Assignment dialog is open on-screen).

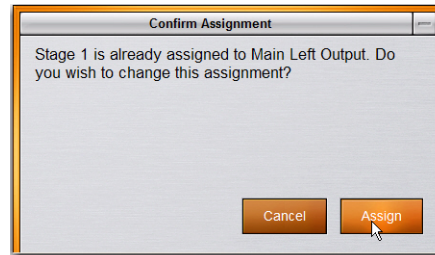

Warning when reassigning an output that is already in use

 To suppress the reassignment warning dialog, hold Default on the console or Alt on the computer keyboard while clicking in the patch grid to change the assignment.

Shortcut for Locating Assignments

Before reassigning in the Patchbay, you may want to double-check the existing assignment to the desired hardware output:

To identify the bus or channels currently assigned to a hardware output:

- Click on any dimmed (already assigned) column number at the top of the Patchbay. The Outputs tab containing the assignment is automatically revealed.

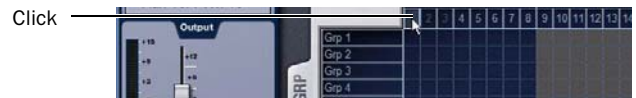

Clicking a column number to "go to" its current assignment

VENUE System Information Export

The System Information Export feature lets you generate an HTML (text) document that details the system's hardware, software and currently loaded Show file configurations. This document can be read by any Internet browser, such as Internet Explorer, Mozilla Firefox or Safari.

 *The patch list can also be exported separately (for more information, see "Patch List Export" on page 113).*

The System Information document can be sent directly to production or rental companies to describe your exact console needs, or it can be re-formatted as desired by copying and pasting into a word processing or spreadsheet application.

To export VENUE System Information:

- 1 Insert a USB key disk into a USB port on the system.
- 2 Go to the Options > System page.
- 3 Click the Info button.



Export VENUE System Information button in Options > System

- 4 Do any of the following:
 - If you have more than one USB key disk connected, make sure the correct USB key disk is selected. If it is not, click Next Disk to cycle through each available disk until the correct one is selected.
 - Click Save to proceed and export system info to the selected USB disk.
 - Click Cancel to dismiss the dialog without exporting.
- 5 Click OK to confirm the export procedure.

You can now remove the USB key disk—from there, you can transfer the exported file to a personal computer for printing, formatting, archiving or distribution.

Standalone Software

When exporting System Info from the Standalone software, the exported System Information file is displayed immediately using the default browser installed on your computer.

VENUE System Information Contents

Exported VENUE System Information is saved as an HTML file, and the file name includes the date and time of the export. Contents include the following (not all data will be generated from the Standalone software):

System Information

Lists the date and time the Info file was generated, as well as the following sections:

FOH Rack Configuration Lists card slot contents for the FOH Rack, or for Mix Rack FOH (local) I/O.

System Configuration Lists information found on the Options > System tab.

Console Lists the current hardware configuration (D-Show Main and D-Show Sidecar(s)) and their Bus ID.

Personal Q Lists Personal Q (PQ) options and status.

Stage Configuration Lists card slot contents for each detected Stage Rack, or for Mix Rack Stage I/O.

Installed Plug-Ins Lists version and other information (as reported by each plug-in) for all currently installed plug-ins, grouped by whether they are Enabled or Disabled. Enabled and In Use plug-ins appear at the top, followed by any remaining enabled (but not In Use) plug-ins. Plug-in information is not available when exporting from the Standalone software.

Show File Information

Lists the name, file path, date and time of the most recently loaded Show file, as well as the following sections:

System Configuration Lists current System Configuration settings as set in the Options > System tab.

DSP Usage Lists the processes assigned to each DSP of each Mix Engine card. Information is sub-divided by Mix Engine as displayed on the Options > Devices tab. This section is not available when exporting from the Standalone software.

Patch List Lists the contents of each Patchbay page. A complete patch list is included in the System Information Export, or a detailed patch list can be exported separately from the Patchbay (see next).

Patch List Export

The Patchbay export generates a patch list in an easily readable format.

To export Patchbay information:

- 1 Insert a USB key disk into any USB port on the console.
- 2 Go to the Patchbay page.
- 3 Click the Export button on the Patchbay page.

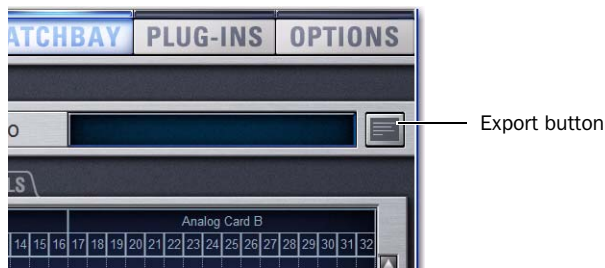

Export Patchbay Information icon

- 4 Do any of the following:
 - If you have more than one USB key disk connected, make sure the correct USB one is selected. If it is not, click Next Disk to cycle through each available disk until the correct one is selected.
 - Click Save to proceed and export Patchbay info to the selected USB key disk.
 - Click Cancel to dismiss the dialog without exporting.
- 5 Click OK to confirm the export procedure. You can now remove the USB key disk and transfer the export file to a personal computer for printing, formatting, and distribution.

 *When exporting a Patch List from the Standalone software, the generated HTML file is automatically opened using your default Internet browser.*

Contents of Exported Patchbay Information

Exported Patchbay information is saved as an HTML file, and the file name includes the date and time of the export. Contents include the following:

Digidesign VENUE Patch List

Show Name, file path, date and time of the last loaded Show file.

Input and Output Patching

The patch list is divided into three sections: Stage, FOH, and Pro Tools.

- Stage inputs show Stage Rack (or Mix Rack Stage outputs) global number 1–96 (as available), input name(s), card slot and number.
- Stage outputs show Stage Rack (or Mix Rack Stage outputs) global number 1-16 (or 32 on expanded systems), output name, card slot and number.
- FOH shows FOH Rack (or Mix Rack FOH/local) inputs and outputs, by the physical input/output name and number.
- Pro Tools inputs and outputs show input/output assignments for Pro Tools HDx- or FWx-equipped systems.
- Unavailable channels are labelled N/A.
- Direct outs are identified uniquely.

Chapter 13: Metering

VENUE provides signal metering on the channels, in the metering section, and on-screen.

Channel Meters

Input and FX return channels provide an input level meter, comp/lim gain reduction meters and exp/gate gain reduction meters.

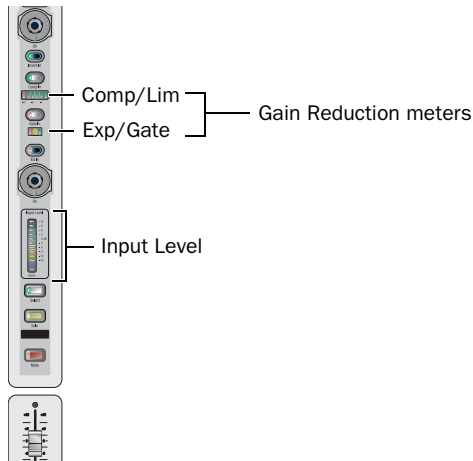

Input channel meters and LEDs

All console channel meters have higher resolution on-screen equivalents that appear in both the targeted channel controls and above the faders in the channel overview.

Meter ballistics and clip margin can be set for channel meters. For more information, see “Metering Options” on page 119.

Input Level Meters

Each Input Channel and FX Return channel strip has a 10-segment bi-color Input Level meter.

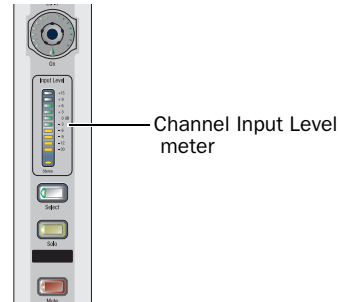

Channel Input Level meter

The 10 bi-color LEDs on the Input Level meters show input levels from bottom to top, according to the following scale:

Channel Input Level meter scale

LED	Level	Color
1 (top)	15 dB	Yellow
2	9 dB	Yellow
3	6 dB	Yellow
4	3 dB	Yellow
5	0 dB	Green
6	-3 dB	Green
7	-6 dB	Green
8	-9 dB	Green
9	-12 dB	Green
10 (bottom)	-30 dB	Green

Dynamics Gain Reduction Meters

Each Input Channel and FX Return channel strip has two gain reduction meters that show the amount of gain reduction applied by the built-in Compressor/Limiter (6-segment meter) or Expander/Gate (3-segment meter).

Compressor/Limiter Meter



Channel Compressor/Limiter gain reduction meter

Channel Compressor/Limiter meter

The 6 LEDs on the Compressor/Limiter meter show gain reduction levels from right to left, according to the following scale:

Channel Compressor/Limiter gain reduction meter scale

LED	Gain Reduction	Color
(none)	0 dB	(none)
1 (right)	3 dB	Green
2	6 dB	Green
3	9 dB	Green
4	12 dB	Green
5	15 dB	Green
6 (left)	21 dB	Red

Expander/Gate Meter



Channel Expander/Gate gain reduction meter

Channel Expander/Gate meter

The Expander/Gate meter works differently depending on which mode the strip is in. The meter is in Gate mode when the ratio is set to its maximum setting (100:1).

Gate When the Gate function is selected, the 3 LEDs on the Expander/Gate meter show the following:

Gate status

LED	Status	Color
1 (right)	Gate open	Green
2	Gate in hold	Yellow
3 (left)	Gate closed	Red

Expander When the Expander function is selected, the 3 LEDs on the Expander/Gate meter show gain reduction levels from right to left, according to the following scale:

Expander gain reduction meter scale

LED	Gain Reduction	Color
(none)	0 dB	(none)
1 (right)	3 dB	Green
2	21 dB	Yellow
3 (left)	> 21 dB	Red

Bank Clip Indicators

The Clip LED at the top of input channels lights when clipping occurs on a hidden fader bank. The channel position of the Clip indication corresponds to the position of the off-bank channel. The Clip LED flashes to indicate momentary clips, and lights solid for sustained clipping.

To locate the clipped channel:

- Press the Bank switches until the Channel Input Level meters show clipping.

For more information, see “Metering Options” on page 119.

Stereo Channel LED

The Stereo LED on input level meters lights to indicate stereo input channels. The stereo channel LED flashes if a 12 dB or greater offset is detected between left and right inputs.

ACS Section Dynamics Meters

The three dynamics gain reduction meters in the ACS section show gain reduction for the built-in Compressor/Limiter, the built-in Expander/Gate, and any applicable Dynamics plug-in on the selected channel.

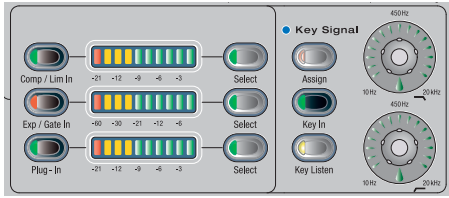

ACS dynamics gain reduction meters

On each meter, the 10 LEDs show dynamics gain reduction from right to left, according to the following scale:

ACS gain reduction meter scale

LED	Gain Reduction	Color
(none)	0 dB	(none)
1 (right)	3 dB	Green
2	6 dB	Green
3	9 dB	Green
4	12 dB	Green
5	15 dB	Green
6	21 dB	Green
7	24 dB	Yellow
8	30 dB	Yellow
9	40 dB	Yellow
10 (left)	60 dB	Red

Meter Bridge

The D-Show Main Unit meter bridge includes meters for the selected channel, the Output section, and the Mains.

All of the 20-segment meters in the meter bridge show levels according to the following scale:

Table 14. Meter bridge 20-segment meter scale

LED	Level
1 (top)	+15 dB
2	+12 dB
3	+9 dB
4	+6 dB
5	+3 dB
6	+1 dB
7	0 dB
8	-1 dB
9	-3 dB
10	-6 dB
11	-9 dB
12	-12 dB
13	-15 dB
14	-18 dB
15	-21 dB
16	-24 dB
17	-30 dB
18	-40 dB
19	-50 dB
20	-60 dB

Selected Channel and Solo Bus Meters

The Selected Channel meters in the meter bridge include two 20-segment bi-color level meters and two 10-segment dynamics gain reduction meters.

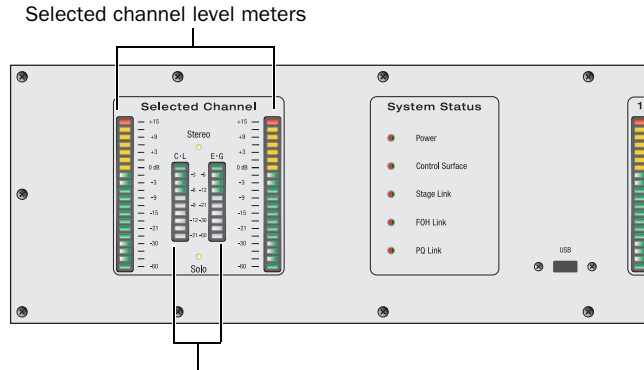

Selected channel gain reduction meters

Selected channel meters in the meter bridge

Selected Channel Level Meters

These meters show mono or stereo levels on the selected channel. The 20 bi-color LEDs show input from bottom to top, according to the scale shown in Table 14 on page 117.

Selected Channel Dynamics Gain Reduction Meters

These meters show gain reduction for the built-in Compressor/Limiter and the built-in Expander/Gate on the selected channel. The 10 LEDs show dynamics gain reduction for the selected channel, from top to bottom, according to the following scale:

Selected channel dynamic gain reduction meter scale

LED	Gain Reduction	Color
(none)	0 dB	(none)
1 (top)	3 dB	Green
2	6 dB	Green
3	9 dB	Green
4	12 dB	Green
5	15 dB	Green
6	21 dB	Green
7	24 dB	Green
8	30 dB	Green
9	40 dB	Green
10 (bottom)	60 dB	Red

Output Section Meters

The eight output level meters in the meter bridge are assignable as a unit for metering of any of the following output types: Groups, Auxes, Matrixes, and Personal Qs.

Stereo Output Metering

With stereo Groups and Personal Qs (which are always stereo), the output level meters in the meter bridge show level for only the highest of the left and right channels.

To see level for both the left and right channels of a stereo output, refer to the on-screen meters, or target the channel on the ACS and use the Selected Channel Level Meters.

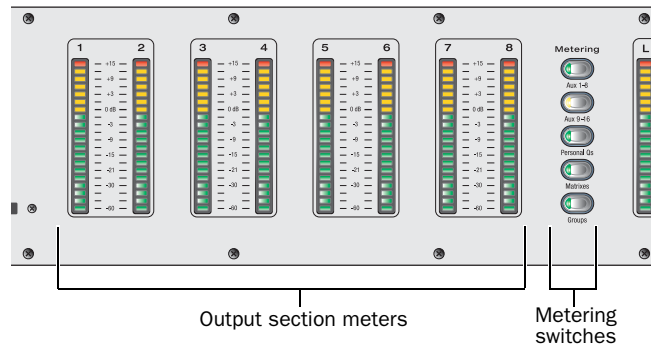

Output level meters in the meter bridge

The 20 bi-color LEDs show input levels from bottom to top, according to the scale shown in Table 14 on page 117.

Selecting Output Meter Display

Output meter display is controlled from the Metering switches to the right of the meters. If no output type is selected, the output meters in the meter bridge follow the output assignment on the Assignable Output Faders.

To select an output type for metering:

- Press the corresponding Metering switch.

To set metering to follow the Assignable Output Faders:

- Press the lit Metering switch to cancel the selection.

Main Output Meters

The three Main output meters in the meter bridge show output levels for the three Main outputs (either in L–C–R or in L–R+M format).

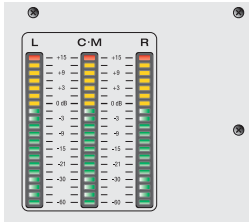

Main output level meters in the meter bridge

The 20 bi-color LEDs show input levels from bottom to top, according to the scale shown in Table 14 on page 117.

Metering on the Solo Bus

Metering Soloed Channels

Solo bus metering depends on the type of channel being soloed.

Single Channels

In PFL, AFL, or SIP modes, a single soloed channel is metered in the same way as if the channel were targeted on the ACS.

Multiple Channels

In PFL or AFL mode, when multiple channels are soloed, the left and right channels of the Solo bus are metered on the Selected Channel meters, pre-Solo Trim control.

In SIP mode, when multiple channels are soloed, the Left and Right Main bus meters are mirrored on the Selected Channel meters.

Dynamics Key Listen

When Key Listen is activated, the left and right channels of the Solo bus are metered on the Selected Channel meters, pre-Solo Trim control.

Solo Clip Indication

When the Selected Channel meters are showing levels of a single soloed channel, the clipping information on the meter bridge LEDs mirrors that on the channel itself.

When the Selected Channel meters in the meter bridge are showing Solo bus levels, the meter LEDs turn red to indicate clipping on the Solo bus.

Metering Options

Meter Display

The following display options can be configured for meters. These options affect all meters on the console.



Metering options in the Interactions tab of the Options page

Meter Ballistics

Meters can be set to operate in the following modes:

RMS Mode (Default) Meters follow the characteristics of a damped analog meter. In this mode, meter response and decay is slower than in Peak mode, providing an average reading of the metered signal. A single LED shows the peak level for the designated Peak Hold Time.

Peak Mode Meters follow the characteristics of a standard peak meter. In this mode, meter response is instantaneous, showing the true peak level of the metered signal.

Peak Hold Time

Peak Hold Time can be set within a range of 0–20 seconds.

To set the Peak Hold Time:

- 1 Go to the Options page and click the Interactions tab.
- 2 Under Meter, enter a value for the Peak Hold Time.
- 3 Press Enter on the keyboard.

Clipping Indication

VENUE meter clip indicators are proximity warnings that show when an input or output signal reaches or exceeds the configured Clip Margin.

Clipping can occur at several points throughout the signal chain. A clip at any one of these points is indicated by lighting the top LED red on the meter. For more information on the location of clip detect points, refer to Chapter 26, “Signal Flow Diagrams.”

Clip Margin

The Clip Margin setting lets you configure the amount of headroom you want before clipping indication begins. Clip Margin is expressed as *dB below maximum* (where maximum is a peak level of +20 dBVU).

Clip Margin can be set within a range of 0 dB to 30 dB below maximum, and is configured separately for inputs and outputs.

To set the Clip Margin:

- 1 Go to the Options page and click the Interaction tab.
- 2 Under Meter, enter values for Input Clip Margin Below Max and Output Clip Margin Below Max.
- 3 Press Enter to confirm the setting.

Clip Hold Time

The Clip Hold Time determines how long a clip indication lasts after the last clipped signal. Clip Hold Time can be set within a range of 0–20 seconds.

To set the Clip Hold Time:

- 1 Go to the Options page and click the Interaction tab.
- 2 Under Meter, enter a value for the Clip Hold Time.
- 3 Press Enter to confirm the setting.

Chapter 14: Solo and Monitor Busses

Solo Bus Modes

Three Solo modes are offered: Pre-Fader Listen (PFL), After-Fader Listen (AFL) and Solo In Place (SIP).

- In AFL or PFL mode, soloing only affects what you hear on the dedicated stereo AFL/PFL Solo (Cue) bus, which feeds the Monitor Bus.
- In Solo In Place mode, soloing only affects what you hear in the Main busses.

Pre-Fader Listen (PFL)

PFL Solo mode sends the signal from explicitly soloed input channels and FX returns to the AFL/PFL Solo (Cue) bus. The signal is post-insert, pre-fader and pre-mute.

Mono input signals are sent to both sides of the Solo (Cue) bus, and the left and right sides of stereo input signals are sent to the corresponding sides of the Solo (Cue) bus.

PFL is the default Solo mode.

After-Fader Listen (AFL)

AFL Solo mode sends the signal from explicitly soloed channels and solo-safe inputs to the AFL/PFL Solo (Cue) bus. Soloing of output busses is always AFL.

In AFL Solo mode, both input and output signals are sent to the Solo (Cue) bus post-fader and post-pan/balance, and are always panned to stereo even if the Main busses are configured in L-C-R mode.

Monitoring Aux and Variable Group Busses with AFL

Linked Aux busses and Variable Group busses use true stereo AFL. When you solo a linked Aux bus, the two busses are heard as a stereo pair on the Solo (Cue) bus.

Mono Aux busses and Variable Group are heard as dual mono on the Solo (Cue) bus.

Solo In Place (SIP)

SIP mode applies to input channels and FX returns only. Solo In Place sends the signal from the soloed channel to the Mains and Monitor busses. Signal is sent post-pan/balance.

⚠ In SIP Solo mode, audio is sent directly to the Main busses. Use this feature with caution.

Selecting a Solo Mode

The Solo mode can be selected from the Solo/PFL section or on-screen.

To select the Solo mode from the console, do one of the following:

- Press the Stereo AFL switch to enter AFL Solo mode.
- Press and hold the Solo In Place switch for at least 2 seconds to enter SIP mode.
- Press a lit Solo mode switch to turn it off. When no switch is lit in the Solo/PFL section, the system is in PFL mode.

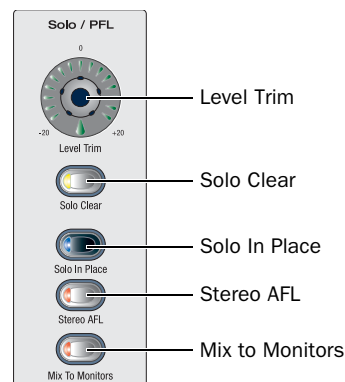

Solo bus controls

To select the Solo mode on-screen:

- 1 Go to the Options page and click the Busses tab.
- 2 Under Solo and Monitor Operations, click the Type pop-up and choose the desired Solo mode.



Choosing the Solo mode in Options > Busses

Solo States and Modes when Loading Shows

Channel Solo States When you load a Show file, all solos are cleared. Solo states are not saved with Show files.

Solo Mode Show files do not open in SIP mode. If you save a Show file while in SIP, when you reopen the Show file, it will open in AFL Solo mode.

Solo Operation Options

Momentary or Latching Switch Operation

Channel solo switches can operate with momentary or latching behavior.

To engage momentary solo on a channel:

- Hold the solo switch for more than one second. Release the solo switch to unsolo the channel.

To latch solo on a channel:

- Press and release the solo switch. Press the switch a second time to unsolo the channel.

Auxes/Variable Groups Follow AFL and AFL Follows Auxes/Variable Groups

You can customize how encoder banking and AFL interact.

Auxes/Variable Groups Follow AFL

When the Auxes/Variable Groups Follow AFL option is selected, soloing an Aux/Var Group bus by pressing its AFL switch assigns level and pan controls for that bus to the input encoders.

- With mono busses, level is assigned to the input encoders. With stereo (linked) busses, level is assigned to the encoders.
- When Flip to Faders is pressed, level is flipped to the faders and pan for the Aux/Var Group bus (even numbered send) is automatically mapped to the input encoders. The pan button flashes while this mode is enabled.

 *If the encoders were already flipped to the faders, flipped status is maintained when an Aux bus is soloed.*

To set Auxes and Variable Groups to follow solo:

- 1 Go to the Options page and click the Busses tab.
- 2 Under Solo and Monitor Operation, select the Auxes/Variable Groups Follow AFL option.



Solo and Monitor Operation settings in the Options > Busses page.

3 Solo an Aux output bus by pressing its AFL switch.

To cancel display of Aux send controls:

- Unsolo the bus, or select any other parameter for the input encoders.

AFL Follows Auxes/Variable Groups

When the AFL Follows Auxes/Variable Groups option is selected, assigning encoders to an Aux/Var Group automatically solos that bus. The AFL Follows Auxes setting is stored and recalled with each Show file. By default, the option is off (not selected).

To set AFL to follow Aux encoder assignment:

- 1 Go to the Options > Busses tab and select the AFL Follows Auxes/Variable Groups option.
- 2 In the Input section, assign encoders to an Aux Send bus.

To cancel (unsolo) in AFL Follows Auxes mode:

- Press the flashing Solo Clear button

 *The Events List can be used to assign the Solo Clear function to a footswitch or any other available trigger.*

Auto Cancel and Input Priority

The Auto Cancel option determines whether Solo switches cancel other soloed channels or are additive (latching). Input Priority determines whether or not soloed inputs replace soloed outputs on the AFL/PFL Solo bus.

To set Solo switch operation:

- 1 Go to the Options page and click the Busses tab.
- 2 Under Solo and Monitor Operations, select the options in any of the following combinations:

Auto Cancel On, Input Priority Off A solo cancels all other solos (inputs and outputs)

Auto Cancel On, Input Priority On An input solo cancels all other soloed inputs; an output solo cancels all other output solos; soloed inputs temporarily replace soloed outputs

Auto Cancel Off, Input Priority Off Solos are additive, and soloed inputs and outputs are heard together

Auto Cancel Off, Input Priority On Solos are additive, and soloed inputs temporarily replace soloed outputs.

Solo Bus Operation

Soloing Channels

Solo operation depends on the type of channel being soloed, and on any selected Solo switch options. In all modes, a channel Solo switch lights to indicate that the channel is soloed.

Input Channels

Pressing a Solo switch on an input channel or FX Return sends signal to the Solo (Cue) bus (when in PFL or AFL modes) or to the Mains bus (when in SIP mode).

In SIP mode only, when a channel is soloed, all other channels that are not soloed or solo safe are implicitly muted. Implicit mutes are indicated by a flashing mute switch.

Output Busses

When the AFL switch in the Output section is pressed, signal is sent to the AFL/PFL Solo bus. This applies to Groups, Auxes, Matrixes, and Personal Qs. Outputs are always AFL.

Soloing Single Channels

To solo a single channel, do one of the following:

- Press the channel's Solo switch so it is lit. The solo switch latches on a momentary press.
 - or –
- Hold the channel Solo switch for more than one second for momentary solo. The channel will automatically unsolo when you release the switch.

Soloing Multiple Channels

To solo multiple channels, do one of the following:

- With the Auto Cancel option enabled, press the Solo switches on multiple channels simultaneously.
 - or –
- Hold Multi-Select (Shift) and press the Solo switches on one or more channels.
 - or –
- With Auto Cancel disabled, press the Solo switches on multiple channels in any sequence. The Solo switches latch on.

Toggling the Solo Status of Multiple Channels

To toggle Solo on multiple channels, do one of the following:

- With Auto Cancel enabled, hold the Multi-Select switch while pressing the Solo switches on channels to toggle.
 - or –
- With Auto Cancel disabled, press Solo switches in any sequence. The Solo switches latch on and off.

Soloing VCAs

When you solo a VCA, its member channels are soloed. If the VCA members include a combination of input and output channels, their solo status follows any Solo switch options. See “Solo Operation Options” on page 122.

To solo the members of a VCA:

- Press the Solo switch on the VCA channels whose members you want to solo so that the Solo switch is lit.

Clearing Solos

Press the flashing Solo Clear switch in the Monitoring section to clear all soloed channels.

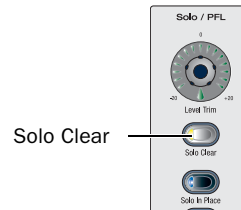

Solo Clear

Solo Bus Metering

When a channel or dynamics key input is sent to the Solo bus, its signal is metered on the Selected Channel meters, temporarily replacing any currently targeted channel. For more information, see “Metering on the Solo Bus” on page 119.

Solo Safing Channels

Solo Safe is a state which prevents a channel from being implicitly muted when any other channel is soloed. Only input and FX return channels can be made solo safe. Solo safed channels are automatically added to any explicitly soloed channels. Solo Safe only applies to SIP and AFL modes. Solo safe status is ignored in PFL mode.

To toggle channel solo safe status, the input switches must be set to Solo Safe mode.

To set Safe switches to control the Solo Safe function:

- 1 Go to the Options page and click the Interaction tab.
- 2 Under Input Safe Switches, select Act as Solo Safes.

To toggle the solo safe status of a channel, do the following:

- Press the Safe switch on the channel.
 - or –
- Click the on-screen Solo Safe button for the channel.



On-screen Solo Safe button

The Safe switch and button flash to indicate the channel is solo safe. When a channel is soloed because of its Solo Safe status, its Solo switch flashes.

Monitor Bus Operation

The Monitor bus outputs signal to both the near-field monitor outputs (FOH Rack) and headphone output on the console. The Monitor bus outputs can also be routed to hardware outputs and to bus-fed plug-ins.

Monitor Bus Switching

The following signals can feed the Monitor bus, listed below in order of priority: Key Listen, Solo (Cue) bus, 2-Track return, COM input, and the Mains mix.

Dynamics Key Listen

Pressing a Key Listen button on-screen sends the key signal from the targeted channel's built-in dynamics processor to the Monitor bus.

Key Listen temporarily overrides the currently enabled Solo bus operation (PFL or AFL), and replaces any other signal on the Monitor bus with the mono key signal.

AFL/PFL Solo Bus

In AFL or PFL mode, signal from any soloed channels is sent to the Monitor bus. When any channel is soloed, the Solo bus overrides the 2-Track return if it is enabled, or the Mains mix if it is currently being sent to the monitors.

2-Track Return

If 2-Track input is enabled, any signal from those inputs is sent to the Monitor bus. If Mix to Monitors is enabled, the 2-Track input overrides it so you can monitor the 2-Track return without having to disable Mix to Monitors.

Mix to Monitors

The Mains mix (the signal present on the Mains busses) can be sent to the Monitor bus.

Assignable Monitor Output

The Monitor bus can be routed to hardware outputs and to bus-fed plug-ins.

A These feeds are in addition to the existing, dedicated Monitor outputs on the FOH Rack and Mix Rack, and are taken post-Monitor Speakers control and post-Monitor bus delay.

Hardware Outputs For routing to hardware outputs, the Monitor (Solo) bus outputs are available in the Mains tab of the Patchbay Outputs page. Monitor bus outputs are assignable to any number of physical outputs on the system. Use this capability to route monitor outputs to multiple cue stations (in-ear mix and wedge mix), or to an outboard analyzer.

Bus-Fed Plug-Ins For routing to bus-fed plug-ins, the Monitor bus appears as a choice in the plug-in routing selector. This lets you route the Monitor bus to a bus-fed stereo plug-in such as an onboard analyzer. Plug-ins can not be inserted on the Monitor bus.

Routing the Monitor Bus to Additional Outputs

To route the Monitor bus to additional outputs:

- 1 In the Patchbay, go to Outputs and click the Mains tab.
- 2 Click in the grid to assign the Monitor output to the desired destination.

💡 Solo In Place, when engaged, is simultaneously routed to the Mains and Monitor busses.

Routing the Monitor Bus to Plug-Ins

To route Monitor output to a bus-fed plug-in:

- 1 Go to the Plug-Ins page.
- 2 Make sure the desired stereo plug-in is installed and assigned to a rack slot.
- 3 Click the Plug-In Input selector at the top of the corresponding rack slot, and choose Bus Outs > Mains > Monitor - stereo.

 *Plug-in outputs cannot be returned to input channels, in order to prevent feedback loops.*



Assigning monitor output to a bus-fed plug-in

Sending the Main Mix to the Monitor Bus

Monitor Output from an L-C-R Main Mix

The stereo Mix to Monitors signal is derived from the L-C-R Main mix by adding a -3 dB signal from the Center channel to the Left and Right monitor channels.

Monitor Output from an L-R+M Main Mix

In a L-R+M Main mix, only the Left and Right channels are heard in the Solo bus.

To send the Main mix to the monitors:

- 1 Do one of the following:
 - Press the Mix to Monitors switch in the Mains section.
 - or –
 - Go to the Options > Busses tab and select the Mix to Monitors option.
- 2 Turn the Monitor Speakers knob or the Headphones knob to adjust the corresponding output level.

Adjusting Solo Bus Level

PFL Solo bus levels can be controlled by the Level Trim knob in the Solo/PFL section, and with the on-screen Level Trim control. The trim amount is adjustable over a range of -20 dB to +20 dB.

Because Level Trim only affects PFL signals, you can easily balance AFL signals or Mix to Monitors with PFL signals, with a minimum of Monitoring level adjustment during a show.

To trim the Solo bus level:

- 1 Solo a channel or press a Key Listen switch.
- 2 Do one of the following:
 - Turn the Level Trim knob to control the amount of signal sent to the Monitor bus.
 - Go to the Options > Busses tab and adjust the Level Trim setting in the Solo and Monitor Operations section.

The following diagrams show the signal flow for PFL and AFL modes.

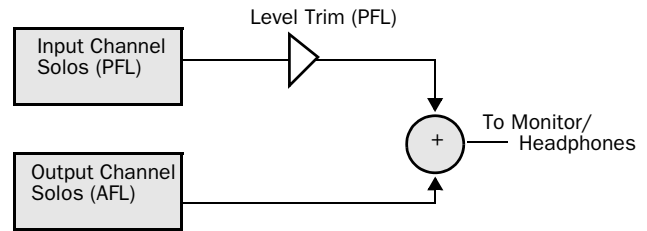

Level Trim in PFL mode

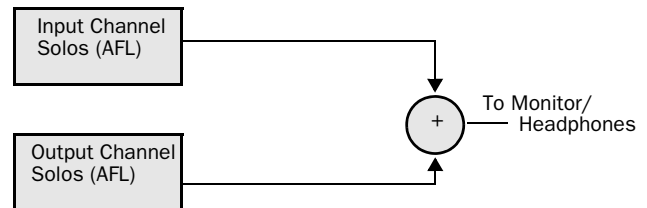

No Level Trim in AFL mode

Adjusting Monitoring and Headphone Level

Output levels for the near-field monitors and headphones are controlled by the corresponding volume knobs in the Monitoring section. You can also use the on-screen controls, or map Cue to the Mains fader.

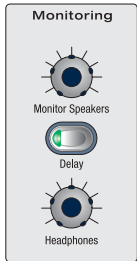

Monitoring controls

Adjusting Monitor Level and Delay

To adjust Solo/Monitor level from the console Monitoring section:

- Adjust the Monitoring or Headphone level, as needed.

 See also "Cue on Mains Fader" on page 126.

To adjust the Solo/Monitor level on-screen:

- Go to the Options > Busses tab.
- In the Solo and Monitor Operations section, adjust the Monitoring encoder.

You can apply an adjustable delay to the monitor outputs and headphone outputs to match the acoustic delay from the main speaker system.

To adjust monitor output delay from the console:

- Press and hold the Delay switch (in the Monitoring section).
- Do one of the following:
 - Turn the Select encoder in the Snapshots & Options section to adjust the delay in fine mode.
 - or –
 - Press and turn the encoder to adjust the delay in coarse mode.

To adjust monitor output delay on-screen:

- Go to the Options > Busses tab.
- Adjust the Delay setting in the Solo and Monitor Operations section. Be sure to click the In button beneath the on-screen encoder to enable Delay. When lit, the Delay setting is applied to the monitor output.

Cue on Mains Fader

The Mains fader can be assigned to control cue (Monitor bus) output level. Enabling the Cue on Mains Fader option lets you adjust solo PFL/AFL level without having to take your hands off the faders. Control of the Mains busses remains available from the Output encoders and on-screen in the Outputs page.

The Cue on Mains Fader setting is stored with the Show file.

To enable Cue on Mains:

- Turn the Monitoring encoder fully counter-clockwise (off).
- Go to the Options > Busses page.
- Under Solo and Monitor Operations, select the Cue on Mains Fader option.



Cue on Mains

The Mains fader now controls Monitoring level. The Mains Select switch flashes quickly.

To exit Cue on Mains (return to normal):

- Go to the Options > Busses page, then click to deselect the Cue on Mains option.

 You can set up an Event to toggle Cue on Mains on or off. See Chapter 22, "Events."

While Cue on Mains is enabled, the Mains busses remain available on-screen, and can be targeted to the ACS.

Adjusting the Mains While Cue On Mains Fader is Enabled

When Cue on Mains Fader is enabled, the Mains output level remains at its last setting and remains accessible on-screen, as follows:

Adjusting Mains On-Screen

You can use the controls in the Outputs page on-screen to select, mute, or adjust the level of any of the Mains busses (L, R and C/Mono). Select a Mains bus on-screen to target it in the ACS, then use the selected channel controls to select, mute, or adjust the level of the Mains busses.

 Mains bus linking/unlinking and Safe controls are only available on-screen while Cue on Mains Fader is enabled.

Talkback, 2-Track and Oscillator Controls

You can assign Talkback microphone input, 2-Track source inputs, and the built-in Oscillator to any Input Channel or FX Return. Talkback, 2-Track, and built-in Oscillator output can be routed to any output busses.

Using Talkback

The Talkback input on the console accepts signal from any dynamic or condenser microphone.

Assigning Talkback Microphone Input

To assign Talkback input to an Input Channel or FX Return:

- 1 Go to the Patchbay > Inputs tab, then click the Channels tab or the FX Returns tab.
- 2 At the top of the channel grid, click the FOH tab.
- 3 Click in the channel grid to assign the Talk input source to an Input Channel or FX Return (listed on the left).



Assigning Talkback input to an Input Channel in the Patchbay

Routing Talkback to an Output

To route Talkback input directly to an output:

- 1 Press the Talkback switch in the Talkback/Osc section so that it is lit.

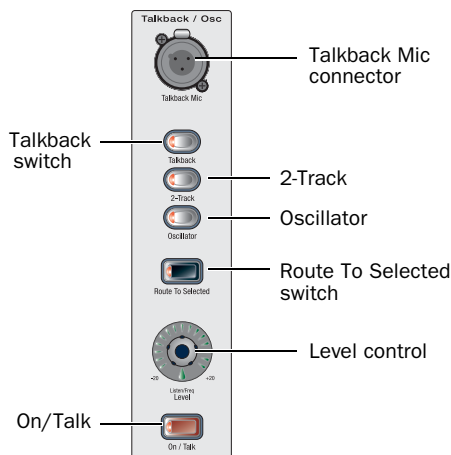

Talkback controls in the Talkback/Osc section

- 2 Press the Route to Selected switch. The switch flashes to indicate Route to Selected mode.

- 3 Press the Select switch on each of the output busses (Auxes, Groups, PQs, Matrixes, or Mains) where you want to send the Talkback signal. The Select switches flash to indicate Talkback assignment.

- 4 Press the flashing Route to Selected switch to confirm the assignment, or press the Cancel switch to cancel the assignment.

To route Talkback directly to an output on-screen:

- 1 Go to the Options > Misc page and click the Route button in the Talkback sections.



Talkback controls in the Options > Misc page

- 2 Go to the Outputs page and click to select the desired output (it flashes briefly).
- 3 In the confirmation dialog that appears, click Route to confirm your assignment or click Cancel to cancel without changing the current routing.

⚠ Signals are routed to output busses post-mute and post fader.

Activating Talkback Input and Setting Level

To activate and set the level for Talkback input:

- 1 Press the Talkback switch in the Talkback/Osc section so that it is lit.
- 2 Activate Talkback by doing one of the following:
 - Press the On/Talk switch in the Talkback/Osc section.
 - Click the on-screen In button in the Talkback section of the Options > Misc page.
- 3 Set the Talkback input level by doing one of the following:
 - Turn the Level knob in the Talkback/Osc section.
 - or –
 - Drag the on-screen Level knob in the Talkback section of the Options > Misc page.

💡 You can designate a footswitch, Function switch or other triggers to control Talkback. For more information, see Chapter 22, “Events.”

Setting Talkback Dim Level

When Talkback is sent directly to an Output bus, the bus program material (minus the talkback signal) is automatically reduced by the amount specified in the Dim Level setting.

To set the Talkback Dim Level:

- 1 Go to the Options page and click the Misc tab.
- 2 In the Talkback section, double-click the Dim Level text box and enter a Dim Level value in the range -60 dB (maximum gain reduction) to 0 dB (no gain reduction).

Activating Phantom Power for Talkback Input

The Talkback input has available $+15$ V phantom power for using a condenser microphone.

To apply phantom power to the talkback mic input:

- On the back panel, move the Talkback Mic Phantom Power switch to the right.

Using the Intercom (“Com”)

The Intercom (“Com”) input on the FOH Rack and Mix Rack can accept input from any compatible dynamic or condenser microphone.

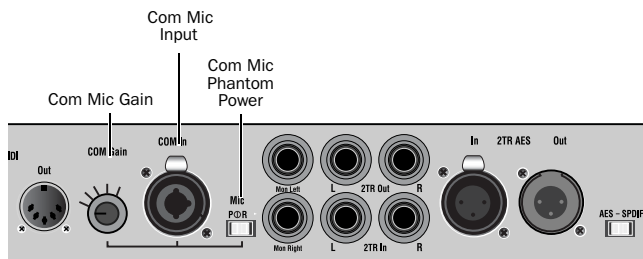

Intercom controls

When activated, the Intercom signal is mixed into the Monitor bus after the source selectors in the Solo/PFL selection, so is audible no matter what source (AFL/PFL, 2-Track, or Main Mix) is sent to the Monitor bus.

The Intercom signal can also be routed to any input or FX return channel.

Routing Intercom Input

To route Intercom input to any input channel or FX return:

- 1 Go to the Patchbay and click the Inputs tab.
- 2 To the left of the channel grid, click the Channels tab or the FX Returns tab.
- 3 At the top of the channel grid, click the FOH tab.

- 4 Click in the channel grid to assign the Com input source (at the top right of the grid) to an Input Channel or FX Return (listed on the left).



Routing Intercom input in the Patchbay

Activating Intercom Input

To activate the Com input so it is mixed with the Monitor bus:

- 1 Route the Intercom input as described in the previous section (“Routing Intercom Input” on page 128).
- 2 Press the Talkback button in the Talkback/Osc section and press the Level encoder to turn COM on/off (its LED ring lights).

Activating Phantom Power for Intercom Input

The Com input has available 15 V phantom power for using a condenser microphone.

To apply phantom power to the Intercom microphone:

- On the back panel of the FOH Rack, move the Com Mic Phantom Power switch to the right.

To set the Intercom microphone input level:

- On the back panel of the FOH Rack, turn the Com Mic Gain knob.

Using 2-Track Inputs and Outputs

Analog and Digital 2-Track Inputs and Outputs are available.

Assigning 2-Track Source Input

To assign the 2-Track inputs to Input Channels or FX Returns:

- 1 Go to the Patchbay > Inputs tab and click the Channels tab or the FX Returns tab.
- 2 At the top of the channel grid, click the FOH tab.
- 3 Click in the channel grid to assign any of the following 2-Track input sources (listed at the top right of the grid) to an Input Channel or FX Return (listed on the left):
 - AL (Analog Left)
 - AR (Analog Right)
 - DL (Digital Left)
 - DR (Digital Right)

Activating 2-Track Input and Setting Level

To feed 2-Track input to the Monitor and Mains busses:

- 1 Go to the Options > Misc screen.
- 2 In the 2-Track section, click the Input Fed to Monitors and Masters pop-up and select Analog 2-Track or Digital 2-Track.

To activate 2-Track input and set level:

- 1 Click the on-screen In button in the 2-Track section of the Options > Misc page.
- 2 Drag the on-screen Level knob in the 2-Track section of the Options > Misc page.



2-Track controls in the Options > Misc page

Routing 2-Track to an Output Bus

To route the 2-Track inputs to an output bus from the console:

- 1 Press the Oscillator switch in the Talkback/Osc section of the Main Unit so that it is lit.
- 2 Press the Route to Selected switch. The switch flashed to indicate Route to Selected mode.
- 3 Press the Select switch on each of the outputs (Auxes, Groups, PQs, Matrixes, or Mains) where you want to route the Oscillator signal. The Select switches flash to indicate Oscillator assignment.
- 4 Press the flashing Route to Selected switch to confirm the assignment, or press the Cancel switch to cancel the assignment.

To route the 2-Track inputs directly to an output bus on-screen:

- 1 Go to the Options > Misc tab.
- 2 Click the Route button in the 2-Track section on-screen. The switch flashes to indicate Route to Selected mode.
- 3 Press the Select switch on each of the output channels (Auxes, Groups, Matrixes, or Mains) where you want to route 2-Track signal. The Select switches flash to indicate 2-Track assignment.
- 4 Click Done in the Route to Selected dialog to confirm the assignment.

⚠ Signals are routed to output busses post-mute and post-fader.

Routing to the 2-Track Outputs

You can route any output bus or Direct Out to the 2-Track outputs.

To route any output bus to the 2-Track outputs:

- 1 Go to the Patchbay and click the Outputs tab.
- 2 To the left of the channel grid, click the tab for an Output bus (Auxes, Groups, PQs, Matrixes, or Mains).
- 3 At the top of the channel grid, click the FOH tab.
- 4 Click in the channel grid to assign an Output bus (listed on the left) to any of the following 2-Track output sources (listed at the top right of the grid):
 - AL (Analog Left)
 - AR (Analog Right)
 - DL (Digital Left)
 - DR (Digital Right)

To route a Direct Output to the 2-Track outputs:

- 1 Go to the Patchbay and click the Directs tab.
- 2 To the left of the channel grid, click the tab for a channel source (Channels, FX Returns, or Outputs).
- 3 At the top of the channel grid, click the FOH tab.
- 4 Click in the channel grid to assign a channel source (listed on the left) to any of the following 2-Track output sources (listed at the top right of the grid):
 - AL (Analog Left)
 - AR (Analog Right)
 - DL (Digital Left)
 - DR (Digital Right)

Routing the Oscillator

The output of the internal oscillator can be routed to Input Channels, FX Returns, or any of the output busses. The Oscillator provides selectable signal type, frequency (for Variable Sine) and signal level, as well as a master on/off switch.

Configuring the Oscillator and Setting Level

To configure the oscillator:

- 1 Go to the Options > Misc page.
- 2 As a precaution, click and drag the on-screen Level encoder down to set Oscillator level to off before you proceed.



Oscillator controls in the Options > Misc page

- 3 In the Oscillator section, click the Signal pop-up and select from the following signal types:
 - 100 Hz Sine
 - 1 kHz Sine
 - 10 kHz Sine
 - Variable Sine
 - Pink Noise
 - White Noise
- 4 If you select Variable Sine, you can set the sine wave frequency with the on-screen frequency control (directly to the right of the Signal pop-up).

To route the Oscillator to an output from the console:

- 1 Configure the Oscillator in the Options > Misc tab.
- 2 Press the oscillator switch in the Talkback/Osc section of the Main Unit so that it is lit.
- 3 Press the Route to Selected switch. The switch flashed to indicate Route to Selected mode.
- 4 Press the Select switch on each of the outputs (Auxes, Groups, PQs, Matrixes, or Mains) where you want to route the Oscillator signal. The Select switches flash to indicate Oscillator assignment.
- 5 Press the flashing Route to Selected switch to confirm the assignment, or press the Cancel switch to cancel the assignment.

To assign the Oscillator signal to an output bus on-screen:

- 1 In the Options > Misc page, click the Route button in the Oscillator section.
- 2 Do either of the following:
 - If you had already selected the desired output, click to confirm the currently displayed Route To mode (in the lower left corner of the screen).
 - or –
 - Go to the Outputs page and click to select an output (it flashes briefly).
- 3 In the confirmation dialog that appears, click Route to confirm your assignment or click Cancel to cancel without changing the current routing.

▲ Signals are routed to output busses post-mute and post fader.

Talkback, 2-Track and Oscillator States When Loading Shows

When you load a Show file, Talkback, 2-Track and Oscillator controls are set to off (deactivated), regardless of their state when the Show was last saved.

Chapter 15: Muting and Mute Groups

Muting

Channels can be muted in three ways: explicitly (lit solid), with the channel mute switch; implicitly (flashing), as a result of another channel being soloed, and as a member of a Mute Group or VCA (flashing).

Mute switches always behave in additive (latched) fashion. Channels can be muted in any sequence, and they will remain muted until they are unmuted.

The following provide some additional information about channels, busses, and muting:

Input Channels and FX Returns Channel mute is pre-fader on input channels and FX returns.

Output Busses Mute operation is post-fader on all types of Output busses.

Mains The mute status of the Main busses is controlled from the Mute switch above the Mains Fader.

Only the linked Mains busses are muted. The Mains Mute switch flashes to indicate not all Mains are muted. For information on linking Mains, see “Linking Mains” on page 81.

VCAs When you mute a VCA, its member channels are muted. The member channel Mute switches flash to indicate they are muted as part of a VCA.

Flashing Mute Indication

A flashing Mute switch indicates the channel is implicitly muted as a result of a Solo or Mute Group activation.

Solo In Solo In Place mode, when a channel or VCA is soloed, all other channels that are not soloed or solo safe are implicitly muted.

Mute Group Members of a mute group are implicitly muted and flash when the mute group is active.

Mute Groups

Channels can be assigned to any of the 8 available Mute Groups. Mute Groups let you mute and unmute multiple channels simultaneously by pressing a single switch.

Any type of channel, including all input and output channels, except VCAs, can be assigned to Mute Groups.

Mute Groups only affect the status of channel Mute switches, and do not affect the on/off status of Aux Sends, output of the Talkback/Oscillator section, or the routing of signals to the monitor outputs.

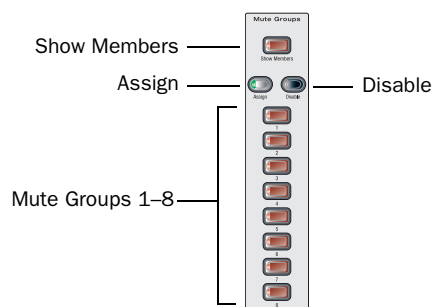

Mute Groups section

Assigning Mute Groups

Mute Groups can be defined from the console or on-screen. Any mixture of channel types can be assigned to a Mute Group. Channels can be assigned to more than one Mute Group.

To assign or remove channels from a Mute Group:

- 1 Press the Assign switch in the Mute Groups section. The Assign switch flashes to indicate Assign mode.
- 2 Press the Mute Group switch (1–8) for the group where you want to assign or remove a channel. This switch flashes to indicate the group is targeted for assignment.
- 3 Press the Select switch for each channel you want to assign or remove from the Mute Group. The Select switches on the selected channels flash.

4 Do one of the following:

- To confirm the Mute Group definition, press the flashing Assign switch or the flashing Mute Group switch (1–8).
- or –
- To cancel the Mute Group definition, press the Cancel switch in the Function section.

To assign or remove members of a Mute Group on-screen:

- 1 Go to the Inputs or Outputs page.
- 2 Click the Assign button in the Mute Groups section (to the right of the on-screen faders). The Assign button flashes to indicate Assign mode.



Mute Group Assign mode

- 3 Below the flashing Assign button, one of the Mute Group buttons 1–8 flashes to show which Mute Group is selected for assignment. If desired, click to select a different Mute Group.
- 4 Click to select the channels you want assigned to the selected Mute Group (click their fader strips to select individual channels; click their on-screen bank numbers to select multiple channels at once).
- 5 Do one of the following:
 - To confirm the Mute Group definition, click the flashing Assign button or the flashing Mute Group switch (1–8).
 - Click the on-screen banner display to show the confirmation dialog, then click Assign.
- or –
- To cancel the Mute Group definition, click the on-screen banner display and click Cancel.

Viewing Members of Mute Groups

You can view Mute Group members in input channels and FX returns.

To view the members of Mute Groups in the Inputs section:

- Press the Show Members switch in the Mute Groups section.

The Bus Assign LEDs 1–8 at the top of each input channel flash in each channel to indicate membership in the corresponding Mute Group. Press Cancel to leave Show Members mode and return the Input section to its previous display.

Using Mute Groups

Mute Groups are activated from the Mute Groups section on the console or from the Mute Group controls on-screen in the Inputs and Outputs pages.

To activate a Mute Group:

- Press a Mute Groups switch 1–8 to mute the members of the corresponding group. The Mute switches of the Mute Group members flash to indicate they are implicitly muted.

To activate multiple Mute Groups:

- Press any number of Mute Group switches 1–8 in any sequence. Mute Groups function in an additive fashion.

To deactivate a Mute Group:

- Press a lit Mute Group switch.

Explicit and Implicit Channel Mute with Mute Groups and VCAs

This section describes the behavior of channel Mute switches when used with Mute Groups and VCAs. Solo/PFL implicit mute behavior is unchanged.

Mute Groups, VCAs and Explicit Mutes

Channels can be muted in three ways:

Explicitly Using the channel Mute switch.

Implicitly As a member of a Mute Group or VCA.

– and –

Implicitly As a result of another channel being soloed.

Using Channel Mute Switches

Any input or output channel implicitly muted by a Mute Group or VCA can be explicitly *un*-muted, explicitly muted, and reset to its implicit mute state by repeatedly pressing a channel Mute switch. Explicitly unmuted or muting a channel in this way does not permanently remove that channel from the Mute Group or VCA.

This feature is useful to temporarily unmute a channel during a line check without having to release the entire Mute Group or VCA.

To cycle through the available Mute modes:

- 1 Activate a Mute Group, or mute a VCA. The Mute switches on all implicitly muted channels flash.
- 2 Press a flashing Mute switch to explicitly unmute the channel. Its Mute switch is now unlit.
- 3 Press the same (now unlit) Mute switch again to explicitly mute the channel. Its Mute switch is now lit solid.
- 4 Press the same Mute switch again to implicitly mute the channel and return it to being controlled by the active Mute Group or VCA. Its Mute switch resumes flashing.

 *Select multiple channels first to be able to toggle all their states at once. The Mute behavior may vary if some, but not all, of the selected channels are members of a Mute Group or VCA.*

Disabling Mute Groups

You can temporarily disable all Mute Group functions. When Mute Groups are disabled, all channels implicitly muted as a result of Mute Group activation are unmuted.

Channels can still be explicitly muted when Mute Groups are disabled. Mute Group assignments are preserved and made available again when Mute Groups are re-enabled.

To disable Mute Groups:

- 1 Go to the Inputs or Outputs pages.
- 2 Click the Disable button on-screen in the Mute Groups section. The Disable switch flashes to indicated disabled state.

To re-enable Mute Groups:

- Click the flashing Disable button in the Mute Groups section.



Mute Group controls on-screen

Function Switches

The D-Show Main Unit provides four Function switches (F keys), labelled F1–4.

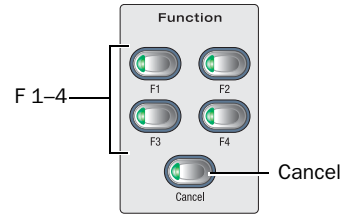

Mute Groups/Function switches (F keys) section

The function and behavior of each Function switch can be customized in the Event List. By default, F1–4 are mapped to Preview mode, Variable Groups mode, channel copy and channel paste, respectively.

For complete information on how to customize these switches, see Chapter 22, “Events.”

Part IV: Processing

Chapter 16: Dynamics

VENUE D-Show systems offer the following dynamics features:

- A built-in Compressor/Limiter and Expander/Gate is available on each input channel.
- Dynamics plug-ins can be used on input and output channels.
- All channels let you inset hardware dynamics processors.
- All built-in and most plug-in dynamic processors support side-chain keying with key filtering.
- Dynamics settings can be copied, pasted, stored and recalled using Snapshots and Presets.

Built-In Dynamics

Each input channel provides a built-in Compressor/Limiter (Comp/Lim), and an Expander/Gate (Exp/Gate). Built-in dynamics are not limited by DSP resources, and can be configured as pre- or post the built-in EQ per channel. Built-in Comp/Lim and Exp/Gate Threshold can be adjusted from the input encoders; all other dynamics parameters can be adjusted using the dedicated Dynamics controls in the ACS, or on-screen.

Plug-Ins

Dynamics plug-ins can be used on input and output channels. When assigned in the plug-in racks, Dynamics plug-ins can be inserted on individual mono or stereo channels or fed by buses. Dynamics plug-ins can be adjusted using the dedicated Dynamics controls in the ACS, or from the on-screen Plug-Ins page. In addition, plug-in presets can be stored and loaded.

 *The Dynamics controls in the ACS provide a unified set of controls for both built-in and plug-in dynamics processing.*

Hardware Inserts

You can insert a hardware Dynamics processor and control its in/out state and insert position on-screen. (See Chapter 19, “Hardware Inserts.”)

Built-In Compressor/Limiter

One built-in Compressor/Limiter (Comp/Lim) is available on each input channel. The Comp/Lim defaults to compression, or can be switched to a limiter by setting the Ratio to its maximum setting. Mono and stereo processing are supported.

Comp/Lim Parameters

Threshold Increases or decreases the threshold level for the built-in Comp/Lim.

Ratio Increases or decreases the ratio for the Comp/Lim. The most extreme clockwise setting (100:1) switches the process into Limiting mode.

Attack Increases or decreases attack time for the Comp/Lim.

Comp Knee Increases or decreases the knee width for the Comp/Lim. A knee value of 0 provides a hard knee setting; 100 provides a soft knee.

Release Increases or decreases release time for the Comp/Lim.

Make-Up Gain Increases or decreases the make-up gain applied by the Comp/Lim.

In/Out Takes the Comp/Lim in or out of circuit (bypass).

Side-Chain Keying Provides side-chain and key listen. Side-Chain features are available on-screen only. For details, see “Side-Chain Keys and Filters” on page 141.

Comp/Lim Gain Reduction Meters

Six-segment gain reduction meters on each input channel indicate Comp/Lim gain reduction from left to right.

Ten-segment gain reduction meters are provided in the ACS for higher resolution metering of the currently selected channel or Dynamics plug-in. (See Chapter 13, “Metering.”)

Comp/Lim Defaults and Ranges

The following table lists the default values and ranges for the built-in Comp/Lim:

Comp/Lim (defaults to Compressor mode)

Parameter	Default	Minimum	Maximum
Threshold	0 dB	-40 dB	+20 dB
Attack	10 ms	100 us	200 ms
Release	100 ms	10 ms	4 sec
Ratio	2:1	1.25:1	100:1
Knee	0 (hard)	0	100
Makeup Gain	0 dB	-40 dB	+20 dB

Built-In Expander/Gate

One built-in Expander/Gate (Exp/Gate) is available on each input channel. The Exp/Gate defaults to gate (Ratio of 100:1, the maximum setting). It can be switched to Expander mode by setting the Range to its minimum setting. Mono and stereo processing are supported.

Expander/Gate Parameters

Threshold Increases or decreases the threshold level for the built-in Exp/Gate.

Ratio Increases or decreases the ratio for the Exp/Gate. The most extreme clockwise setting (100:1) puts the process into Gate mode. Lower settings enable Expander mode.

Attack Increases or decreases the attack time for the Exp/Gate.

Gate Hold Increases or decreases the time the gate holds.

Release Increases or decreases the release time for the Exp/Gate.

Range Sets the maximum range or depth of attenuation of the gate on that channel.

In/Out Takes the Exp/Gate in or out of circuit (bypass).

Side-Chain Keying The Exp/Gate supports side-chain and key listen. For details, see “Side-Chain Keys and Filters” on page 141.

Exp/Gate Gain Reduction Meters

Three-segment gain reduction meters for the built-in Exp/Gate are located in each input fader strip. These provide constant display of gain reduction on all currently banked input channels.

10-segment gain reduction meters are provided in the ACS for metering of the Exp/Gate on the currently selected channel. (See Chapter 13, “Metering.”)

Exp/Gate Defaults and Ranges

The following table lists the default values for the Exp/Gate:

Exp/Gate Defaults (defaults to Gate mode)

Parameter	Default	Minimum	Maximum
Threshold	0 dB	-60 dB	+20 dB
Attack	1 ms	20 us	500 ms
Release	250 ms	10 ms	4 sec
Ratio	100:1 (Gate mode)	1.25:1	100:1
Gate Hold	100 ms	10 ms	4 sec
Gate Range	-20 dB	-80 dB	0 dB

Adjusting Dynamics

The VENUE D-Show Main Unit provides Dynamics controls in input channel strips, the ACS, and on-screen.

Input Fader Strip Dynamics Controls

All Input fader strips provide Threshold level controls, dedicated In/Out switches and gain reduction meters.

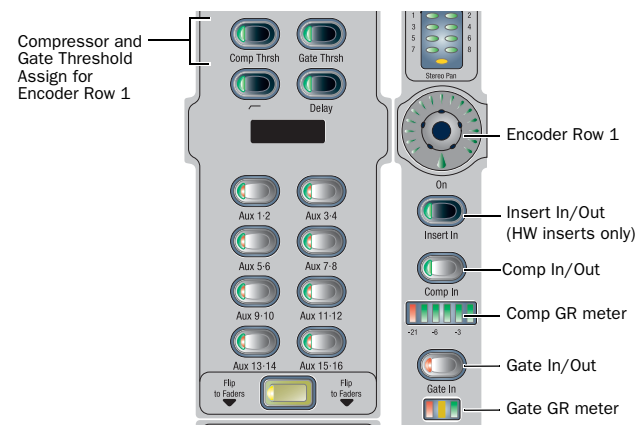

Dynamics controls and displays on input channels

To adjust Threshold from an input strip:

- 1 Press an Encoder 1 Assign switch (Comp/Lim, or Exp/Gate).
- 2 Rotate a channel Encoder 1 to adjust Threshold.

To take the process in/out of circuit:

- Press the Comp In or Gate In switch.

ACS Dynamics Section

The Dynamics controls in the ACS provide a unified, consistent set of controls for both built-in and plug-in dynamics processing for the targeted channel. Its six dual-purpose rotary/switch encoders, three In/Out switches, three Select switches, and dedicated high-resolution gain reduction meters provide a familiar way to adjust and view any type of Dynamics parameters and their settings.

All D-Show-compatible Dynamics plug-ins map their controls to the appropriate ACS encoders and switches.

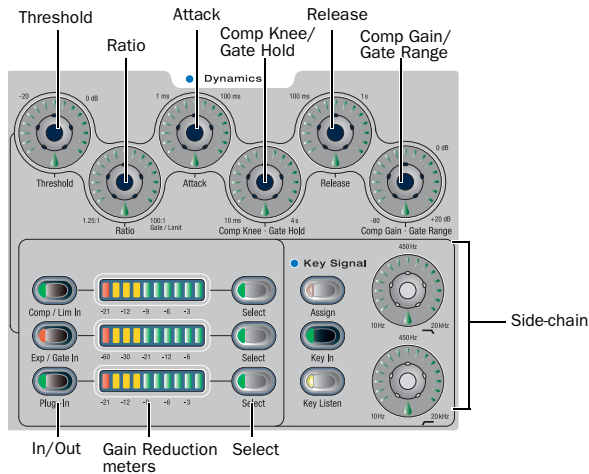

Dynamics controls in the ACS

To adjust Dynamics parameters from the ACS:

- 1 Target a channel by pressing its Select switch.
- 2 Press the Dynamics Select switch for the corresponding process:
 - For the built-in Compressor/Limiter, press the Comp/Lim Select switch.
 - For the built-in Expander/Gate, press the Exp/Gate Select switch.
 - For a Dynamics plug-in, press the Plug-In Select switch.
- 3 Adjust the appropriate Dynamics parameter. (See “Rotary and Switch Functionality” on page 26.)

To take the process in/out of circuit:

- Press the appropriate In/Out switch in the ACS Dynamics section (Comp/Lim, Exp/Gate, or Plug-In).

To reset an entire Dynamics section to its default settings:

- Hold the Default switch while pressing the Comp/Lim or Exp/Gate Select switches in the ACS Dynamics section.

Software Screen Dynamics Controls

The software screen lets you adjust built-in or plug-in dynamics on-screen, with simultaneous access to Comp/Lim and Exp/Gate parameters (including their side-chain settings).

The Inputs screen also provides the Dynamics Graph display. The Dynamics Graph displays a composite response of the compressor and gate that you can use to view and edit built-in Dynamics parameters.

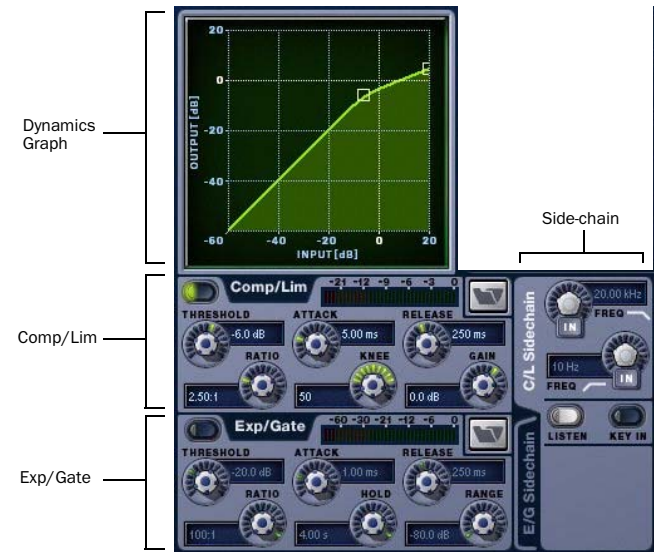

Dynamics controls in the software screen

To adjust Dynamics parameters on-screen:

- 1 Select a channel on-screen.
- 2 Adjust the on-screen controls as needed:
 - For the built-in comp/lim or exp/gate, adjust the parameter on-screen.
 - For plug-ins, click the Insert slot displaying the Dynamics plug-in to go to the Plug-Ins page.

To reset an on-screen Dynamics parameter to its default value, do one of the following:

- Alt-click the control.
 - or –
- Right-click the control and choose Reset.

To reset an entire Dynamics section to its default settings:

- Hold the Default switch and press the Comp/Lim or Exp/Gate Select switches in the ACS Dynamics section.
 - or –
- On-screen, right-click anywhere on the Compressor/Limiter or Expander/Gate sections (but not directly on an encoder or button) and choose Reset.

Using the Dynamics Graph Display

In addition to the on-screen encoders and buttons, you can adjust Dynamics parameters using the Dynamics Graph.

To adjust Dynamics on-screen using the Graph display:

1 Select a channel on-screen, and make sure the Comp/Limiter or the Exp/Gate is in circuit, and targeted in the Dynamics Graph.



Dragging a handle in the Dynamics graph

 If the channel EQ is currently the target of the Dynamics Graph, click anywhere in the on-screen Comp/Limiter or Exp/Gate sections to change the display.

2 Drag handles in the on-screen Dynamics Graph to adjust Threshold and Ratio.

 The Dynamics Graph does not support Fine adjust mode using the Fine switch.

Adjusting Dynamics Plug-Ins

Dynamics plug-ins map their threshold, ratio, attack, release, gain, and filter controls to the corresponding in the ACS. (Dynamics controls on input strips can only control built-in dynamics processors.)

 If more than one Dynamics plug-in is inserted on a channel, only the first Exp/Gate will map to the ACS. You can use the Output encoders in Insert mode to control any additional Dynamics plug-ins on the channel.

To adjust a Dynamics plug-in from the console:

1 Target the channel with the plug-in by pressing the channel Select switch.

2 Press the plug-in Select switch (located next to the ACS gain reduction meters in the Dynamics section), then do one of the following:

- If the plug-in maps correctly, adjust parameters by pressing or turning the corresponding encoders in the ACS Dynamics section.
- If the plug-in does not map to the ACS, press the Insert Mode switch in the Output section. Use the Output encoders to adjust parameters; use the Previous Page and Next page switches to access other parameters.

Channel Modes Affecting Dynamics

Both the Channel Config settings for Input Direct mode and Dyn Pre EQ affect operation of built-in Dynamics.

Dyn Pre EQ

By default, built-in Dynamics processing occurs before built-in EQ processing in the signal chain of input channels. This can be changed on a per-channel basis by toggling the channel's Dyn Pre EQ setting.

To toggle the Dyn Pre EQ setting on a channel:

- 1 Target the input channel by pressing its Select switch.
- 2 In the Channel Config section, press the Dyn Pre EQ switch. (On-screen, click the Dyn Pre EQ button in the (channel) Config section in the upper right corner of Inputs screen.)



Channel Config controls in the Inputs page

When enabled, the Dyn Pre EQ LED lights.

Input Direct Mode

Input Direct mode lets you completely bypass any and all built-in dynamics and EQ, plug-ins and inserts processing on input channels and FX returns.

To toggle Input Direct mode:

- 1 Target the input channel by pressing its Select switch.
- 2 Press the Input Direct switch in the Channel Config section of the ACS. (On-screen, click the Input Direct button in the (channel) Config section in the upper right corner of the Inputs page.)

When enabled, the Input Direct LED flashes.

Dynamics Settings and Presets

Built-in Dynamics settings can be copied and pasted between channels. Settings can also be stored, loaded, and transferred as dynamics Presets.

Copying and Pasting Dynamics Settings

To copy and paste dynamics settings:

- 1 Right-click anywhere in the Comp/Lim or Exp/Gate areas of the on-screen Dynamics section and choose Copy Comp/Lim Settings, or Copy Exp/Gate Settings.



Copying dynamics settings

- 2 Go to the channel where you want to paste the settings.
- 3 Right-click in the Comp/Lim or Exp/Gate areas of the desired channel's on-screen Dynamics section and choose Paste Comp/Lim Settings or Paste Exp/Gate Settings.

To copy and paste all of a channel's built-in Dynamics settings:

- 1 Right-click in the on-screen Dynamics Graph and choose Copy Dynamics Settings.
- 2 Select the channel where you want to paste the settings.
- 3 Right-click in the on-screen Dynamics Graph of the new channel and choose Paste Dynamics Settings.

Presets for Built-In Dynamics

You can store and load settings as presets for built-in and plug-in dynamics processors from the console or on-screen.

To save or load a preset:

- 1 Adjust dynamics settings on a channel (if saving a preset), or select an input channel (to load a preset).

- 2 Click the Comp/Lim or Exp/Gate Presets icon on-screen.



Built-in dynamics Presets buttons

- 3 If necessary, select the appropriate Presets folder by clicking and selecting it from the Folder selector.

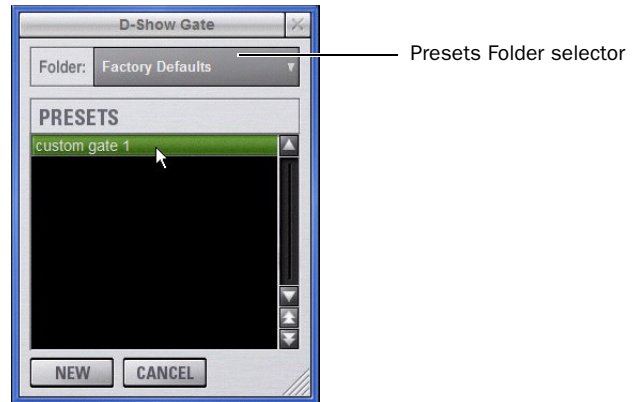

Previewing a preset in the Presets window

- 4 Do one of the following:
 - To preview an existing preset, click its name in the Presets window.
 - To load the currently selected preset, press Enter or click the Close box (X) in the Presets window title bar.
 - To save the current dynamics settings as a new preset, click New and enter a name for the preset file.
 - To cancel without changing settings, click Cancel.

Side-Chain Keys and Filters

The built-in Comp/Limiter and Exp/Gate support side-chain triggering.

Key In/Out

The Key In switch toggles the key signal in or out of circuit for the built-in Comp/Lim or Exp/Gate.

To toggle the side-chain key signal in or out of circuit, do one of the following:

- Click the Key In button in the side-chain controls of the on-screen Dynamics section.

When the Comp/Limiter key is in, it uses its own source channel (Self) as the key source signal. When the Exp/Gate key is in, it can be self-keyed or use any other available channel.

Key Assign

The on-screen Key Assign selectors lets you select the side-chain source for a gate (compressors are always keyed by the channel signal) and its pickoff. The Key Source selector is provided in the Exp/Gate controls.

Key Sources

The Compressor/Limiter is self-keyed. You can use any of the following as the key source for the Exp/Gate:

- Self
- Any Input (Channel or FX Return)
- Any hardware input

You can also specify the pickoff source for the key signal for input channels.

To select the key signal for the Gate on-screen:

- 1 Select an Input Channel.
- 2 Click the E/G Side-Chain tab in the Dynamics section to select the gate.
- 3 Click the Key Source selector and choose an available channel or bus.



Choosing a Key Source

To select a pickoff point for the key source signal:

- Click the Source Pickoff selector and choose a pickoff source for the selected key signal:

Key Listen

The Key Listen button toggles the key onto the Solo (Cue) bus, replacing any currently soloed channel.

Key Listen always overrides the Solo bus (previously soloed channels are suppressed until Key Listen is cleared). Pressing Solo on other channels while Key Listen adds them but they remain suppressed.

Key Listen is also exclusive to itself; pressing Key Listen on a different processor or channel replaces the previous Key Listen with the new Key Listen.

- ⚠ *Key Listen on a Dynamics plug-in does not route the signal to the Solo bus, but to the plug-in output. Use caution.*

To engage Key Listen:

- Click the Listen button in the on-screen Exp/Gate controls.

To disengage Key Listen:

- Click Listen again. The Solo bus reverts to its previous signal. You can press Solo Clear to turn off any engaged Key Listen. Press Solo Clear a second time to clear channel solos, if any.

Side-Chain Filters

Both the Comp/Limiter and Exp/Gate side-chains provide two bands of EQ to band-limit the key signal.

To enable a side-chain filter on-screen:

- 1 Click the C/L Side-Chain or E/G Side-Chain tab in the Dynamics section to select the desired processor.
- 2 Click the LPF or HPF side-chain filter In buttons.

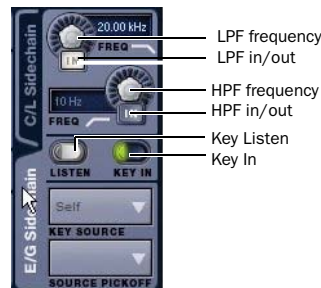

Side-Chain controls in the software screen (Exp/Gate shown)

To adjust a side-chain EQ:

- Turn the HPF or LPF encoder to adjust the frequency. On-screen, the LEDs around the encoder light, and the current frequency value is displayed on-screen.

Dynamics side-chain EQ defaults and ranges

Filter	Default	Minimum	Maximum
HPF	10 Hz, Off	10 Hz	20 kHz
LPF	20 kHz, Off	10 Hz	20 kHz

Side-Chain Limitations

Side-chain Key signals can be routed from these sources:

- Channel pre/post fader pickoff
- FX Return pre/post-fader pickoff
- Channel Insert return (when the channel does not have a hardware insert assigned)

There are no limits to the number of side-chain Key signals.

- ⚠ *Side-chain level may vary dramatically depending on where the Key signal is sourced. The top of channel pickoff can be as much as 18 dB louder than other pickoff points and sources.*

Chapter 17: EQ

The following EQ features are available on VENUE D-Show systems:

- A built-in EQ is available on each input channel and FX return.
- Graphic EQs are available for use on output channels.
- EQ plug-ins can be used on input and output channels.
- All channels let you insert hardware EQ processors.
- EQ settings can be copied, pasted, stored and recalled using Snapshots and Presets.

Built-In EQ

Different types of built-in EQ are available for input channels, FX returns, and outputs.

Input Channels Each input channel provides a high-pass filter plus a built-in four-band parametric EQ. EQ can be set for digital or analog mode. In digital mode only, the four-band EQ provides selectable Bell/Shelf shapes for the Hi and Lo bands. Input channel EQ can be configured as pre- or post-Dynamics on a per-channel basis.

FX Returns Each FX return provides a built-in two-band EQ. FX return EQ can be used in digital or analog mode; in digital mode, the bands can be individually configured for Bell or Shelf modes.

Graphic EQs

Output busses can have a built-in Graphic EQ assigned to them.

EQ Plug-Ins

EQ plug-ins can be used on input and output channels. When assigned in the plug-in racks, EQ plug-ins can be inserted on individual mono or stereo channels or fed by busses. EQ plug-ins can be adjusted using the ACS, using the Output encoders (in Insert mode), or from the on-screen Plug-Ins page. Plug-in presets can be saved and loaded.



The EA controls in the ACS provide a unified set of controls for both built-in and plug-in EQ processing.

Hardware Inserts

You can insert a hardware EQ processor and control its in/out state and insert position on-screen. See Chapter 19, “Hardware Inserts.”)

Built-In EQ Parameters

HPF

Each input channel provides a fourth-order high-pass filter (HPF) with adjustable corner frequency and in/out control. The input HPF defaults to 20 Hz, out-of-circuit.

You can adjust HPF frequency and in/out state from each input strip, from the ACS, or on-screen.

Input Parametric EQ

Input channels and FX returns provide built-in parametric EQ. The following parameters are available in the built-in EQ, and can be adjusted using the EQ controls in input fader strips, the ACS, or on-screen.

EQ In

EQ In toggles the built-in EQ processor (all bands) in or out of circuit on the selected channels. EQ In/Out can be controlled from each input fader strip, from the ACS, or on-screen.

Analog and Digital EQ Modes

The Analog/Digital button toggles the built-in parametric EQ between digital mode and analog mode, on a per-channel basis. Analog/digital mode switching is available on-screen.

Digital Mode A standard digital parametric EQ. Frequency range of 20 Hz to 20 kHz and gain range of +/-18 dB are available on all four bands. Hi and Lo bands can be Bell (default) or Shelf. Digital Q is expressed in Q factor terms in the range 10 (left, a narrow band) to 0.1 (right, a wide band). Digital Mode is the default EQ mode.

Analog Mode An EQ with a response modeled on that of an analog console renowned for its EQ section. Frequency range is limited to match, and the outer bands provide shelving only. Analog Q is expressed in octaves of *bandwidth* in the range 0.1 (left, a tenth of an octave) to 2 (right, two octaves.)



The HPF does not change when the EQ is switched between Digital and Analog mode.

Gain, Frequency, and Q/Bandwidth

Each band of built-in parametric EQ provides the following parameters, as available on input channels or FX returns:

Gain Boosts or cuts the corresponding band. LEDs around the Gain encoder light from the center-point to the right (boost), or from the center-point to the left (cut) to show current Gain.

Freq Sets the center or corner frequency, as follows:

- Freq sets the center frequency for the Hi-Mid and Lo-Mid bands, and for the Hi and Lo filters when in Bell mode.
- Freq sets the corner frequency for the Hi and Lo filters when in Shelf mode. (See “Bell and Shelf Modes for Hi and Lo Filters” on page 144.)

Turning the encoder clockwise increases the frequency for that band; turning it counter-clockwise decreases the frequency. A single LED around the encoder shows the current encoder setting. The available range of each band depends on the EQ mode (Digital or Analog). See “Control Ranges for Built-In Parametric EQ (All Modes)” on page 150.

Q (Q/Bandwidth) Controls Q (in digital mode) or bandwidth (analog mode).

◆ In Digital mode, Q determines Q factor. When the Hi or Lo filters are in Shelf mode, the Q knob determines the Q of the shelf.

◆ In Analog mode, this control changes to a bandwidth control which performs essentially the same function.

Band In/Out Each of the available EQ bands can be taken in or out (bypassed) using their encoder (or on-screen).

◆ On the console, the Gain knob for each band serves as the in/out control by pushing the encoder. The indicator LED lights to indicate band In.

◆ On-screen, a dedicated In/Out switch is located just below each Gain knob.

Bell and Shelf Modes for Hi and Lo Filters

In digital EQ mode, the Hi and Lo filters on input channels and FX returns can be toggled between Bell and Shelf modes.

When in Bell mode, the Hi or Lo filters function as a parametric EQ with variable Q. When in Shelf mode, the Hi module is a high-shelf EQ, and the Lo module is a low-shelf EQ. For instructions on configuring these bands for Bell or Shelf mode, see “Adjusting EQ” on page 144.

Adjusting EQ

You can adjust EQ controls in input channel strips, in the ACS, and on-screen.

Input Fader Strip EQ Controls

Each input strip provides HPF and EQ In/Out controls.

- HPF can be adjusted on each Input Channel using the Encoder 1 HPF assignment switch and corresponding row of encoders.
- The EQ In switch takes the built-in parametric EQs in or out of circuit.

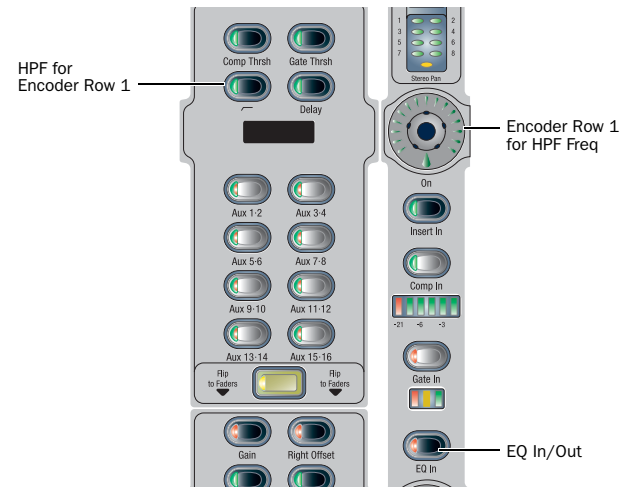

EQ controls and displays on Input Channels

To adjust HPF from an input strip:

- 1 Bank to the channel on the control surface.
- 2 Press the HPF Encoder 1 Assign switch.
- 3 Rotate the appropriate channel Encoder 1 to adjust HPF frequency. Press the appropriate encoder shaft switch to toggle HPF in or out.

💡 *HPF can also be adjusted in the ACS or on-screen.*

To bypass built-in parametric EQ (all bands) from an input strip:

- 1 Bank to the channel on the control surface.
- 2 Press the EQ In switch. When in circuit, the EQ In switch is lit. When built-in EQ is bypassed, the switch is unlit.

ACS EQ Controls

The EQ controls in the ACS provide a unified, consistent set of controls for both built-in and plug-in EQ processing for the targeted channel. One dual-purpose rotary/switch encoder controls the HPF. Twelve dual-purpose rotary/switch encoders control EQ parameters and their settings.

D-Show-compatible EQ plug-ins can map their controls to the ACS EQ section, and all plug-ins can be controlled using the Assignable Output Encoders.

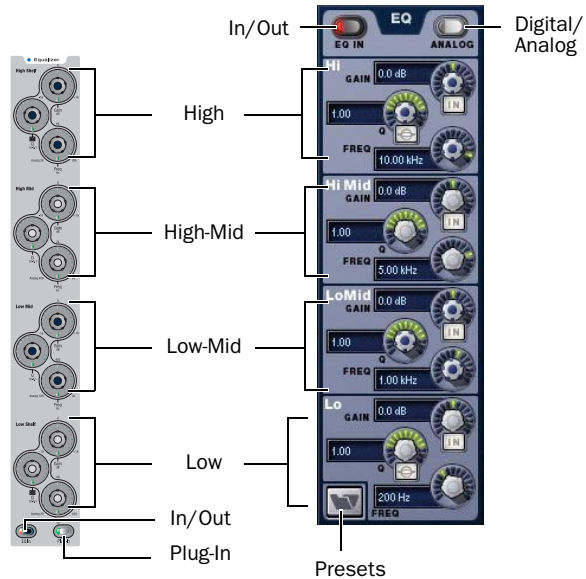

EQ controls in the ACS (left) and on-screen (right) for an Input Channel
FX Returns provide two bands of EQ (Hi and Lo) which can be toggled between Bell and Shelf modes.

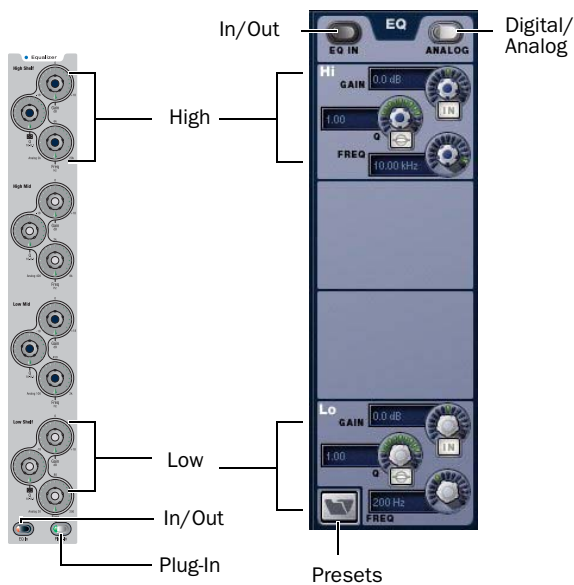

EQ controls in the ACS (left) and on-screen (right) for an FX Return

To adjust EQ parameters from the ACS:

- 1 Target a channel by pressing its Select switch.
- 2 Press the EQ In switch to enable built-in EQ on that channel. (The EQ In switch is provided in the ACS as well as in each input fader strip.)
- 3 Adjust the appropriate EQ encoder.

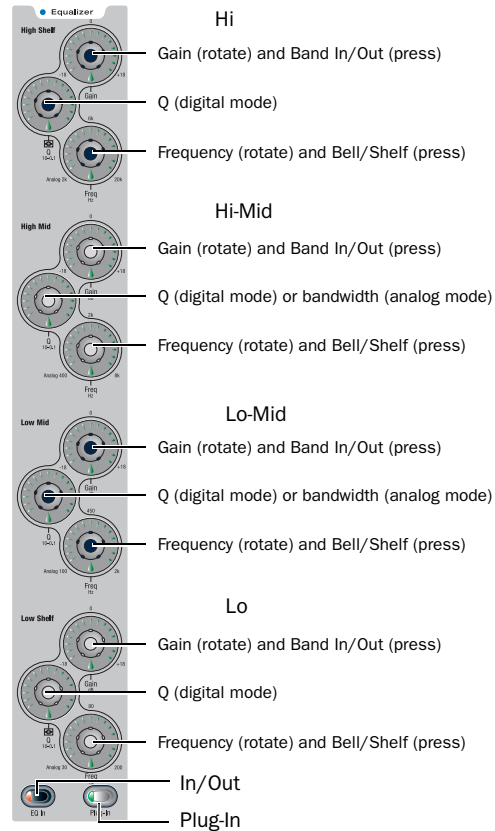

EQ controls in the ACS

To reset an EQ parameter to its default value:

- Hold the Default switch and adjust the control.

To reset the entire EQ section (all bands) on a channel:

- Hold the Default switch and press the EQ In switch.

Software Screen EQ Controls

You can adjust the built-in EQ using dedicated on-screen buttons for band in/out and bell/shelf toggling.

The software screen also provides the EQ Graph display to adjust frequency and gain simultaneously.

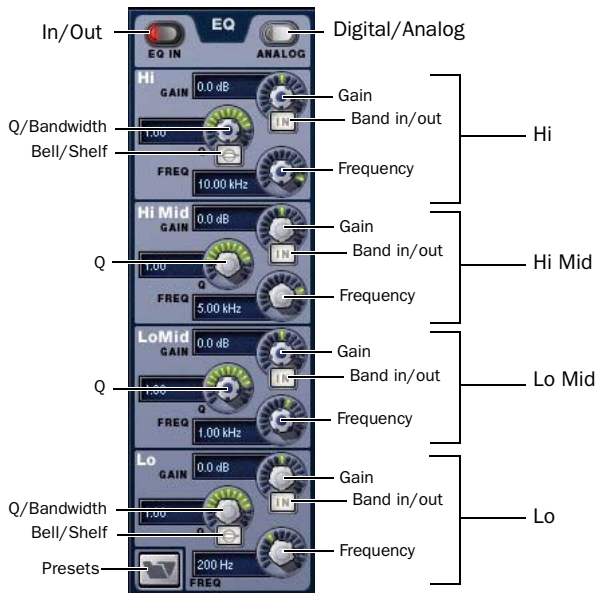

EQ controls in the software screen (4-band Input Channel EQ shown)

To adjust parametric EQ parameters on-screen:

- 1 Select a channel on-screen.
- 2 Click the EQ In switch to put the EQ in circuit.
- 3 Adjust the on-screen controls by doing one of the following:
 - Turn an on-screen knob (Gain, Q/Bandwidth, or Frequency) for each frequency band.
 - Click to toggle any on-screen EQ switch (EQ in/out, band in/out, or bell/shelf).
 - Click a displayed value and type a new value.
 - Drag up or down in a value display to increase or decrease the value.

To reset an on-screen EQ parameter to its default value, do one of the following:

- Alt-click the control (or, hold the console Default(Alt) switch and click the control).
- Right-click the control and choose Reset.

To reset the entire EQ section (all bands) on a channel, do one of the following:

- Right-click anywhere in the EQ section on-screen (but not directly on an encoder or button) and choose Reset EQ Section.
- Hold Default and click the on-screen EQ In button.

Using the EQ Graph Display

The on-screen EQ graph lets you use the mouse to adjust frequency and gain for any available EQ band.

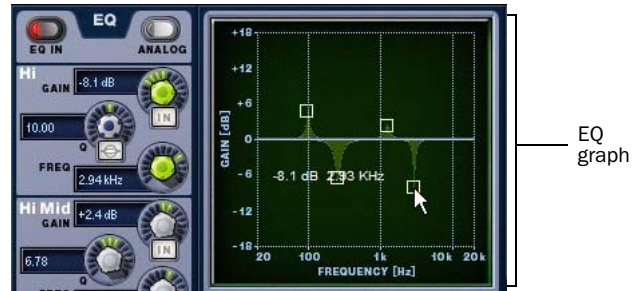

Dragging handles in the EQ graph display

To adjust EQ on-screen using the Graph display:

- 1 Select a channel on-screen.
- 2 Click the EQ In switch to put the EQ in circuit.
- 3 Drag the handles in the on-screen EQ graph display for each EQ band (Lo, Lo-Mid, Hi-Mid, or Hi), as follows:
 - Drag a handle right or left to increase or decrease frequency.
 - Drag a handle up or down to increase or decrease gain.

Adjusting EQ Plug-Ins

EQ plug-ins can map their gain, frequency, and Q/bandwidth controls to corresponding encoders in the ACS.

When a plug-in provides additional parameters beyond those that map to the dedicated EQ encoders, you can use the Output encoders.

 All plug-ins, including EQ plug-ins that do not map directly to dedicated EQ encoders, can be controlled using the Output encoders in Insert mode.

To adjust an EQ plug-in from the console:

- 1 Target the channel with the plug-in by pressing the channel Select switch.
- 2 Press the Plug-In Select switch (near the bottom of the ACS EQ section).
- 3 Do one of the following:
 - If the EQ plug-in maps correctly, adjust parameters by pressing or turning the corresponding encoders in the ACS EQ section.
 - If the EQ plug-in does not map to the ACS controls, press the Insert Mode switch in the Output section. Use the Output encoders to adjust parameters; use the Previous Page and Next page switches to access other pages, bands, and parameters.

 For more information, see Chapter 18, "Plug-Ins."

Channel Modes Affecting EQ

The following features affect operation of built-in EQ.

Dyn Pre EQ

By default, built-in Dynamics processing occurs before built-in EQ processing in the signal chain of input channels. This can be changed on a per-channel basis by toggling the channel's Dyn Pre EQ setting.

To toggle the Dyn Pre EQ setting of an input channel:

- 1 Target the channel whose Dyn Pre EQ mode you want to change by pressing its Select switch.
- 2 Press the Dyn Pre EQ switch in the (Channel) Config section. (Or, in the on-screen channel Config section click the Dyn Pre EQ switch.)



Dyn Pre EQ

Dyn Pre EQ button

When enabled, the Dyn Pre EQ switch LED lights.

Input Direct Mode

Input Direct mode lets you bypass the built-in dynamics and EQ processing, and all inserts on Input Channels and FX Returns.

To toggle Input Direct mode:

- 1 Target the input channel by pressing its Select switch, and make sure the Inputs page is displayed.
- 2 Press the Input Direct switch in the (Channel) Config section. (Or, click the Input Direct button in the channel Config section in the upper right corner of the Inputs page.) When enabled, the Input Direct LED lights.

Graphic EQ for Outputs

A built-in 31-band Graphic EQ can be inserted on Mains, Groups, Auxes, Matrixes, and PQs. The Graphic EQ provides +/- 12 dB of gain and constant Q.

Assigning a Graphic EQ to a mono channel uses one available Graphic EQ. Assigning a Graphic EQ to a stereo channel uses two available Graphic EQs.

Graphic EQs can be adjusted on-screen, or using the input faders on the Main Unit that provide access to four banks of 8 frequency bands each.

Configuring Graphic EQs

To configure the number of Graphic EQs:

- 1 Put the system into Config mode.
- 2 Go to the Options page and click the System tab.
- 3 Click the Edit button on-screen.
- 4 Choose the number of Graphic EQs from the pop-up menu. You can choose to dedicate processing resources to provide 0, 8, 16, or 24 Graphic EQs.

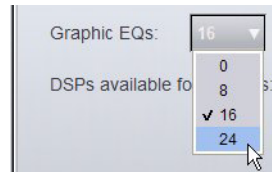

Configuring the number of Graphic EQs

Inserting Graphics EQs on Outputs

To insert a Graphic EQ on an Output bus:

- 1 Target the bus by pressing its Select switch.
- 2 In the Outputs page, click the 31-Band Graphic Equalizer tab.
- 3 Click the Graphic EQ pop-up menu and choose an available mono or stereo Graphic EQ.

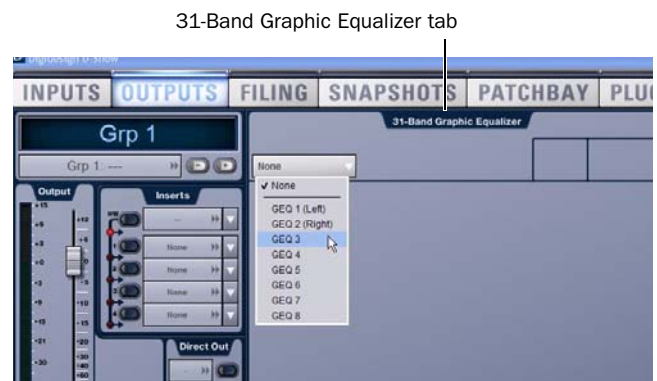

Assigning a graphic EQ (mono)

The 31-Band Graphic EQ appears on-screen.

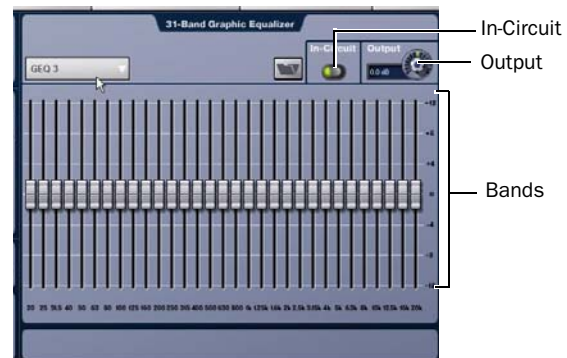

31-band graphic EQ

Graphic EQ Controls

The Input Faders of the Main Unit provide control of Graphic EQ in/out, and targeting of EQ bands. You can also use on-screen controls to adjust graphic EQ parameters.

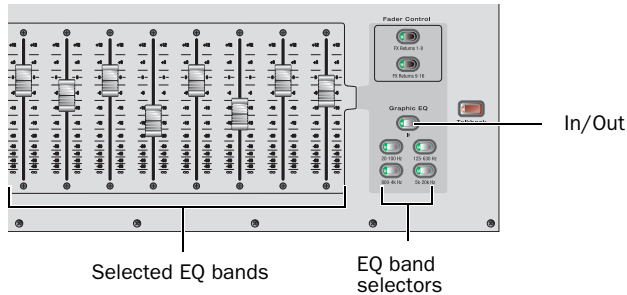

Graphic EQ controls on the control surface

To enable the graphic EQ:

1 Target an Output bus with a graphic EQ assigned. If no graphic EQ is assigned, display the 31-Band Graphic Equalizer tab in the Outputs page and assign one using the Graphic EQ pop-up menu.

2 Press the Graphic EQ In switch, or click the In button on-screen, to toggle in/out status. When enabled, the In/Out switch LED lights.

To set a graphic EQ curve:

1 Press the Graphic EQ band switch or click on-screen to select the appropriate bank of graphic EQ bands: (20 to 100 Hz, 125 to 630 Hz, 800 Hz to 4 kHz, or 5 kHz to 20 kHz).

2 Adjust one of the eight faders controlling the selected graphic EQ bands.

3 Press another Graphic EQ band switch or click on-screen to select another bank of graphic EQ bands and adjust as needed.

To adjust graphic EQ gain:

- Use the eighth fader in the fifth band (5 kHz to 20 kHz), or use the on-screen Output knob.

Resetting Graphic EQ Parameters

To reset a band to its default setting, do one of the following:

- Hold the Default switch and press the Select switch on the fader corresponding to the graphic EQ band.
- Right-click the individual band fader on-screen and choose Reset.
- Alt-click the band on-screen.

To reset the entire graphic EQ to flat:

- Right-click anywhere in the Graphic EQ section on-screen (but not directly on a fader) and choose Reset GEQ Section.

EQ Settings and Presets

Built-in parametric and Graphic EQ settings can be copied and pasted between channels. EQ presets can also be saved and loaded to archive and transfer settings.

Copying and Pasting EQ Settings

To copy and paste an EQ setting:

1 Do one of the following:

- To copy a parametric EQ setting, right-click the on-screen EQ section or EQ graph (not on an encoder) and choose Copy EQ Settings.

– or –

- To copy a Graphic EQ setting, right-click the graphic EQ display (not on a fader) and choose Copy GEQ Settings.



EQ Reset/Reset/Reset pop-up menu

2 Go to the channel where you want to paste the settings.

3 Do one of the following:

- To paste a parametric EQ setting, right-click in the new channel's EQ section or graph and choose Paste EQ Settings.

– or –

- To paste a Graphic EQ setting, right-click in the new channel's Graphic EQ section and choose Paste GEQ Settings.

Presets for Built-In and Graphic EQ

You can store and load EQ settings to disk as Preset files. Presets can be used with built-in and plug-in EQ processors, including the graphic EQ. Preset files can be moved between systems and used for other Shows. Presets can be accessed from the control surface or on-screen.

💡 Check the Factory Presets folder for preconfigured settings.

To save or load a preset:

1 Adjust EQ parameters as needed.

2 Click the EQ Presets icon on-screen. (The Presets icon is available in the Inputs screen EQ section, and in the graphic EQ screen for an output channel).

3 Choose a Presets folder in the Folder display at the top of the Presets window. If necessary, choose the appropriate Presets folder by selecting it from the Folder pop-up menu.

 For more information, see Chapter 20, “Shows and File Management.”



Presets window

Presets icon

EQ Presets window

4 Do any of the following:

- To preview an existing preset, click its name in the Presets window.
- To load the currently selected preset, press Enter or click the Close box in the Presets window title bar.
- To load a preset and close the Presets window, double-click the preset.
- To save the current EQ settings as a new preset, click New and enter a name for the preset file.
- To cancel without changing settings, click Cancel.

To save or load a preset for the Graphic EQ:

1 Go to the Outputs page for the channel on which the graphic EQ is assigned. If necessary, click the 31-Band Graphic Equalizer tab to display the graphic EQ on that channel.

2 Click the Presets icon (above the EQ bands, next to the In-Circuit button).

3 Choose a Presets folder in the Folder display at the top of the Presets window. If necessary, choose a different Presets folder by clicking and selecting it from the Folder pop-up menu.

4 Do any of the following:

- To preview an existing preset, click its name in the Presets window.
- To load the currently selected preset, press Enter or click the Close box in the Presets window title bar.
- To load a preset and close the Presets window, double-click the preset.
- To save the current graphic EQ settings as a new preset, click New and enter a name for the preset file.
- To cancel without changing settings, click Cancel.

Control Ranges for Built-In Parametric EQ (All Modes)

Table 18. Control ranges for built-in parametric EQ

Band	Control	Range (Digital)	Defaults (Digital)	Range (Analog)	Defaults (Analog)
High (Bell/Shelf)	Frequency	20 Hz to 20 kHz	10 kHz	2 kHz to 20 kHz	6 kHz
	Gain	±18 dB	0 dB	±15 dB	0 dB
	Q/Bandwidth	10 to 0.1	1.0	Shelf only	none
High-Mid	Frequency	20 Hz to 20 kHz	5 kHz	400 Hz to 8 kHz	2 kHz
	Gain	±18 dB	0 dB	±15 dB	0 dB
	Q/Bandwidth	10 to 0.1	1.0	0.1 to 2.0 octaves	0.2
Low-Mid	Frequency	20 Hz to 20 kHz	1 kHz	100 Hz to 2 kHz	450 Hz
	Gain	±18 dB	0 dB	±15 dB	0 dB
	Q/Bandwidth	10 to 0.1	1.0	0.1 to 2.0 octaves	0.2
Low (Bell/Shelf)	Frequency	20 Hz to 20 kHz	200 Hz	30 Hz to 200 Hz	80 Hz
	Gain	±18 dB	0 dB	±15 dB	0 dB
	Q/Bandwidth	10 to 0.5	1.0	Shelf only	none

Fader Banks and Graphic EQ Frequency Bands

VENUE D-Show Main Unit Fader Banks and Graphic EQ Frequency Bands

Main Unit Fader Number	17	18	19	20	21	22	23	23
Bank 1 20 to 100 Hz	20 Hz	25 Hz	31.5 Hz	40 Hz	50 Hz	63 Hz	80 Hz	100 Hz
Bank 2 125 to 630 Hz	125 Hz	160 Hz	200 Hz	250 Hz	315 Hz	400 Hz	500 Hz	630 Hz
Bank 3 800 Hz to 4 kHz	800 Hz	1000 Hz	1.25 kHz	1.6 kHz	2 kHz	2.5 kHz	3.15 kHz	4 kHz
Bank 4 5 kHz to 20 kHz	9	10	11	12	13	14	15	16
Freq	5 kHz	6.3 kHz	8 kHz	10 kHz	12.5 kHz	16 kHz	20 kHz	GEQ Output level

Chapter 18: Plug-Ins

This chapter explains how to install and configure plug-ins before a performance, and how to use plug-ins during a performance.

Plug-Ins can be inserted on all channels and bus outputs, or used as bus processors for effects such as reverb and delay.

 For complete information on VENUE-compatible plug-ins, visit the Digidesign website (www.digidesign.com).

Plug-Ins Quick Start

Before a performance, enable Config mode and do the following:

- Install plug-ins (see “Installing and Authorizing Plug-Ins” on page 151).
- Assign plug-ins to racks and rack slots (see “Plug-In Racks” on page 156).
- Assign plug-in input and output routing, including side-chain routing (see “Assigning and Routing Plug-Ins” on page 159).
- View and adjust plug-ins using the console or software screen (see “Adjusting Plug-Ins” on page 162).
- Save and load plug-in settings as Presets, or with snapshots (see “Plug-In Presets and Snapshots” on page 164).

During a performance, do all of the following:

- Enable Show mode to “safe” (lock out) plug-in rack assignments and other plug-in rack operations that could interrupt a performance.
- Patch channels and busses to available plug-ins, re-assign plug-in routing, or re-assign existing side-chain routing.
- Adjust plug-in parameters from the ACS, Output Encoders, or on-screen.
- Save and load plug-in settings as Presets, or within snapshots.

Using Config and Show Modes for Plug-Ins

The current Console mode status (Config or Show mode) determines which plug-in functions are available.

Config mode is required to install plug-ins, assign them to rack slots, and to establish side-chain routing. When in Show mode, any operations that might interrupt audio throughput are locked out and unavailable.

 *Plug-In actions that interrupt audio require Config mode. For more information, see “Config Mode and Show Mode” on page 34.*

Installing and Authorizing Plug-Ins

Plug-ins can be installed and authorized on systems using their installer discs or USB storage devices. (Plug-ins are not able to be installed or adjusted using only the Standalone software.)

 *Because installing plug-ins can interrupt audio throughput, always install plug-ins before a performance.*

Installing Plug-Ins

To install a plug-in:

- 1 Put the system into Config mode.
- 2 If installing from a CD-ROM, insert the installer disc into the system CD-ROM drive.
- 3 Go to the Options page and click the Plug-Ins tab. The following two lists are shown:

Plug-Ins to Install This list shows available plug-in installers. At the top of the list is the Device selector, which provides a pop-up menu of available media sources. Plug-In installers are stored locally after plug-in installation, and appear as available items when Previous Installs is selected from the Device selector. This lets you re-install plug-ins without the original CD-ROM or other media.

Installed Plug-Ins This list shows all plug-ins already installed on the system. The plug-ins shown in plain text are available to process audio. Plug-Ins listed in italics are disabled and unavailable (see “Enabling and Disabling Installed Plug-Ins” on page 154).

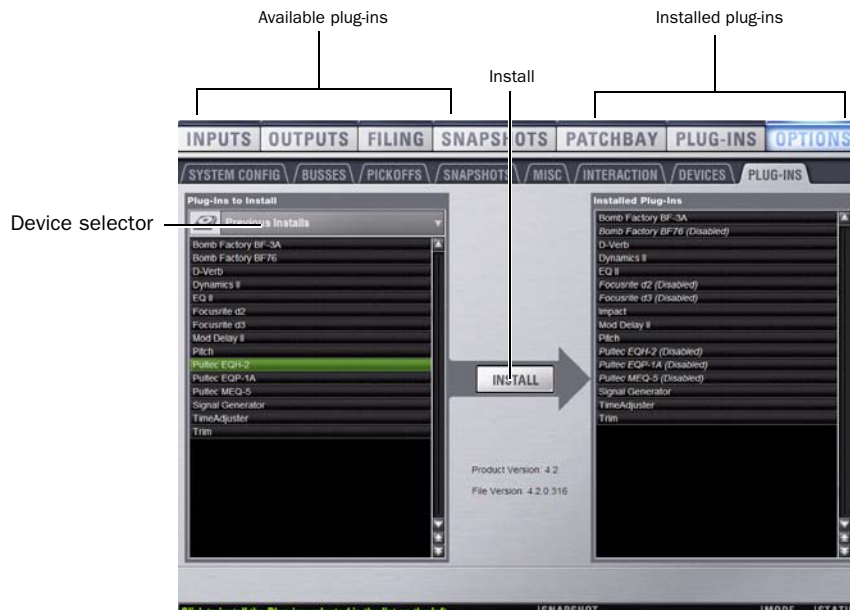

Figure 10. Options > Plug-Ins screen

4 Click the Device Selector pop-up menu and do one of the following:

- Choose Previous Installs to access any plug-in installers after a system update.
- Choose Console to access all factory-installed plug-in installers. after a system update or a full system restore.
- Choose an external storage device, as available, to access plug-in installers loaded in the CD-ROM drive.



Choosing a Device

5 Select a plug-in from the Plug-Ins to Install list on the left by doing any of the following:

- Click to select a single installer.
- Shift-click to select multiple contiguous installers.
- Control-click to select or deselect installers one at a time.

6 Click Install to install the selected plug-ins. Once installed, the plug-in appears in the Installed Plug-Ins list on the right.

7 Repeat as necessary to re-install all plug-ins needed on the system.

Installing Plug-Ins Manually

If a plug-in does not appear in the Plug-Ins to Install list, it may not have a fully compatible VENUE installer and must be manually installed. This is required the first time you install the plug-in, and whenever you need to re-install a plug-in (such as after using the System Restore CD to update or reset the system).

 A plug-in without a VENUE installer may still be compatible. Consult the plug-in manufacturer for compatibility information.

To install a plug-in manually:

- 1 Make sure all sound systems are shut down or muted.
- 2 Insert the plug-in installer disc into the CD-ROM drive.
- 3 Go to the Options page and click the System tab.
- 4 Hold the Ctrl key and click Shutdown Console on-screen. Follow on-screen directions to exit to the Desktop.
- 5 Copy the plug-in installer to the partition named User Data.
- 6 Launch the plug-in installer application and follow any on-screen directions. If prompted, do not restart the system from a plug-in installer. (Doing so will not harm the system, but will take longer, especially if you have multiple plug-ins to install manually.)
- 7 Quit the installer application and eject the installer disc.
- 8 Click the Return to D-Show shortcut on the desktop to re-launch the VENUE D-Show software.
- 9 Go to the Options page and click the Plug-Ins tab. Verify that the manually installed plug-in appears in the Console list of available plug-ins.

Authorizing Plug-Ins

After installing a plug-in, the system re-creates the list of available plug-ins. Whenever the racks initialize, the system checks authorizations for all installed plug-ins. If no previous authorization for a plug-in is recognized, you will be prompted to try a demo version, or authorize the full version of the plug-in.

VENUE D-Show software supports challenge/response and iLok USB Smart Key authorization, including pre-authorized iLoks and iLok Authorization cards.

Challenge/Response Challenge/response authorization is only valid for the single system the plug-in is currently installed on. Challenge/response codes can be communicated using any computer with Internet access.

 *It is not possible to connect a VENUE system to the Internet directly.*

iLok USB Smart Key Plug-Ins supporting web authorizations through iLok.com can be authorized for your iLok Smart Key from any computer with Internet access. This lets you take your iLok and your plug-in authorizations anywhere, to use plug-ins installed on any system.

 *VENUE systems provides multiple USB ports that can be used to connect an iLok. For more information, see Chapter 2, "Configuring and Connecting D-Show."*

To authorize a plug-in:

1 When a plug-in authorization dialog appears, do one of the following:

- To try a demo of the plug-in, click Try.
- or –
- To have the system recognize the required authorization on your iLok, click Authorize. Insert your iLok Smart Key into any available USB port when prompted.

 *Do not choose Internet Activation. Use Challenge/Response or an authorized iLok Smart Key for plug-in authorization.*

2 Follow the instructions on-screen to complete the software authorization process.

Managing Plug-Ins on the System

To keep your system up to date and running smoothly, always the current recommended versions of your plug-ins.

Use the following features to check and maintain plug-in compatibility, to disable plug-ins, and how to remove and delete plug-ins and their installers.

Plug-in Version Checker

VENUE D-Show software includes a comprehensive database of plug-in version and compatibility information that can help you maintain current versions of all your plug-ins. It also lets the system warn you when you are about to downgrade a plug-in (install an older version over a newer version).

 *See the VENUE plug-in pages on the Digidesign website (www.digidesign.com) for the most up to date information.*

To view plug-in version information:

- 1 Go to the Options > Plug-Ins page.
- 2 Select a single plug-in from the Plug-Ins to Install or Installed Plug-Ins list (version information is not shown for a multi-selection).

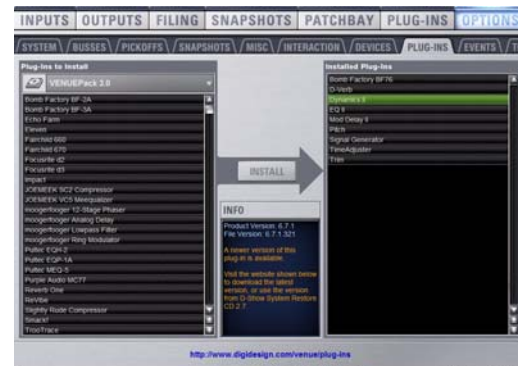

Info about a recommended update in Options > Plug-Ins

The Info pane shows details about the currently selected plug-in, including whether a newer version of the plug-in is available and whether it is a recommended update or a critical update.

If you choose to install a plug-in for which there is a known or recommended update, the system asks you to confirm.



Dialog shown when attempting to install a plug-in that has a known newer version.

A similar dialog appears when attempting to replace an installed plug-in with an older version of the same plug-in. Follow the instructions on-screen to install anyway, or cancel.

Using System Info to View Plug-in Version Information

Plug-in version information is included in exported System Info data. The Plug-in sections of the exported System Info file show critical and recommended updates, with links to sites to download or check for newer versions.

To use System Info for Plug-In Version Maintenance:

- 1 Insert a USB key disk into an available USB port.
- 2 Go to the Options > System page.
- 3 Click the Info button.

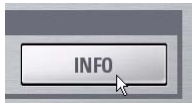

Export VENUE System Information button in Options > System

- 4 Do any of the following:
 - If you have more than one USB key disk connected, make sure the correct USB key disk is selected. If it is not, click Next Disk to cycle through each available disk until the correct one is selected.
 - Click Save to proceed and export system info to the selected USB disk.
 - Click Cancel to dismiss the dialog without exporting.
- 5 Click OK to confirm the export procedure.
- 6 Remove the USB key disk.

You can now transfer the exported file to a personal computer for printing, formatting, archiving or distribution. If viewing the System Info document from a computer with internet access, use the included links to check for plug-in updates.

Automatic Plug-ins Cleanup During Show Load

Plug-ins are verified while Show files are loaded to streamline plug-in lists and menus. Unused plug-ins (plug-ins that were once installed but subsequently uninstalled or disabled) are identified, and will appear in lists and menus *italicized*.

At any time, the plug-in lists can be reset manually using the Remove Unavailable Plug-ins command. This command results in the following:

- Plug-ins that are not available and not in use in the rack are automatically filtered from plug-in menus when the show file is stored. This filtered list is saved with the Show file.
- Plug-ins that are not available but are in use remain in the rack and display a warning icon in their rack slot, and are listed *italicized* in plug-ins menus.

Enabling and Disabling Installed Plug-Ins

The Installed Plug-Ins list shows Disabled plug-ins in *italics*. Plug-Ins can be manually disabled and enabled to manage DSP resources, troubleshoot possible conflicts, and to manage plug-in availability.

To globally disable or enable a plug-in:

- 1 Click to select the plug-in name in the Installed Plug-Ins list, at the right of the Options > Plug-Ins tab.
- 2 Right-click the plug-in and select whether to disable or enable the selected plug-in.

If assigned to any rack slots, the plug-in will be displayed as unavailable and inactive.

Removing and Deleting Plug-Ins and Installers

Removing a plug-in “uninstalls” the plug-in from the racks, but its installer remains in the Previous Installs cache, making it easier to reinstall the plug-in at a later time without requiring the installer CD or other media. (See “Removing Plug-Ins” on page 154.)

Deleting a plug-in completely removes it and its installer from your system. (See “Deleting Uninstalled Plug-Ins” on page 155.)

The list of plug-ins you see in VENUE D-Show software is updated automatically each time you load a Show file to keep plug-in lists and menus uncluttered.

You can also remove or delete plug-ins and/or their installers manually.

 *Installing, uninstalling, and deleting plug-ins are not supported using the Standalone software.*

Removing Plug-Ins

To uninstall a plug-in from the system but leave its installer available:

- 1 Put the system in Config mode.
- 2 Go to the Options page and click the Plug-Ins tab.

3 Right-click the specific plug-in name from the right-hand list and choose the Uninstall option for the selected plug-in.

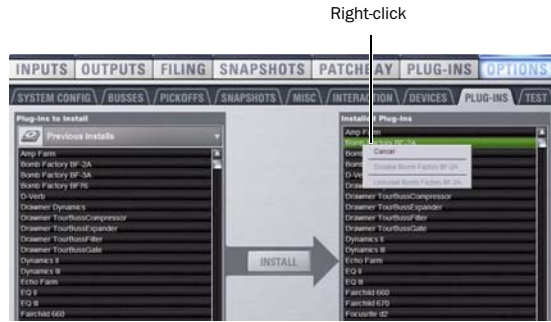

Uninstalling a plug-in

Removing Unavailable Plug-ins from the Racks

Unavailable plug-ins can be removed from rack slots using the Remove Unavailable Plug-Ins command.

To manually remove unavailable plug-ins:

- 1 Put the system in Config mode.
- 2 Make sure the plug-in rack is fully initialized (the Status indicator displays OK).
- 3 Click the Plug-In selector in any rack slot and choose Remove Unavailable Plug-Ins. This menu item is only available when one or more unavailable plug-ins are present in the rack.
- 4 Click Remove to proceed, or click Cancel. If you proceed with the removal:
 - All unavailable plug-ins are removed from the rack.
 - Italicized entries for unavailable plug-ins are removed from all plug-in menu lists.
 - All references to unavailable plug-ins are removed from the Insert Processing section of all affected channels, and the insert point plug-in is set to None.
 - All references to unavailable plug-ins are removed from all snapshots.

The new, updated list of available plug-ins is subsequently saved to the Show file.

History File and Removing Plug-ins

A History file is written immediately before removing unavailable plug-ins from the rack, letting you recall that History file to revert the system to its state prior to removing plug-ins.

Reinstalling a Removed Plug-in

To reinstall a removed plug-in:

- 1 Put the system in Config mode.
- 2 Go to the Options page and click the Plug-Ins tab.

3 Click the Device selector and choose Previous Installs.

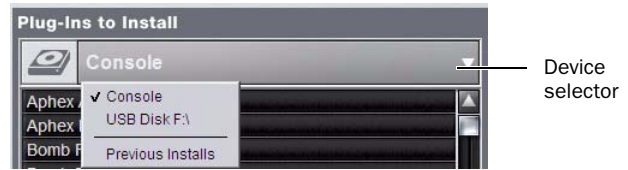

Choosing a Device

4 Select the plug-in and choose Install. If the desired plug-in is not listed, it must be re-installed from the original CD-ROM or other media.

Deleting Uninstalled Plug-Ins

Once a plug-in is uninstalled, its installer can be deleted from the system. (Plug-ins which are currently installed cannot be deleted).

To completely remove a plug-in and its installer:

- 1 Put the system in Config mode.
- 2 Go to the Options page and click the Plug-Ins tab.
- 3 Select Previous Installs from the Device selector.
- 4 Right-click the plug-in name and choose the Delete option for the selected plug-ins. The plug-in is removed from the system, and the stored plug-in installer is removed from the Previous Installs list.

Overview of Working with Plug-Ins

The Plug-Ins screen displays the plug-in Racks, where the majority of plug-in features are located.

To access the Plug-Ins page:

- Press the Plug-Ins switch in the View Mode section (or click the Plug-Ins tab). By default, the Plug-Ins page displays all four racks, which are empty until plug-ins have been assigned. (See also “Jump To” Plug-Ins” on page 163.)



Plug-In racks (no plug-ins assigned)

You populate the racks by *assigning* plug-ins in rack slots. During a performance, plug-ins that have been assigned in rack slots can be inserted on channels and routed to/from busses on-screen. Plug-in parameters can then be adjusted from the console as well as on-screen.

Plug-In Racks

The Plug-Ins page provides four plug-in racks. Each of the four racks has 25 slots into which you can load a plug-in. The four different racks can be viewed all at once, individually, and in varying zoom levels.



Figure 11. Plug-In racks and rack slots, Main view, with custom rack names shown.

Naming Plug-In Racks

By default, the racks are named Rack 1, Rack 2, Rack 3, and Rack 4. You can rename each rack as needed.

To rename a plug-in rack:

- 1 Double-click the rack name to highlight it on-screen.
- 2 Type a new name and press Enter. To return a rack to its default name, leave the name blank and press Enter.

 *Plug-Ins can be placed in any rack slot. Use the different racks to organize processing functions such as Dynamics, EQ, Reverb, or Group Inserts.*

Rack Views

The Plug-Ins page can be displayed in Full or Zoom views, with the option to display either view in Mini-view mode.

Full View

The default view of the rack screen is Full view, in which all four racks are shown (see Figure 11). This screen provides access to all rack slot controls, and shows an icon representing each assigned plug-in. This lets you quickly see what plug-ins are available, and adjust their routing.

Zoom View (Plug-In View Mode)

In Zoom view, a single rack remains on-screen to the left, and the rest of the screen displays the targeted plug-in.



Zoom view, with a plug-in window open on-screen

To toggle Full or Zoom view modes, do one of the following:

- Press the Plug-Ins switch (in the View Modes section), or click the View toggle switch (upper right corner of the rack).

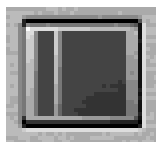

Zoom/Full view toggle

– or –

- Double-click a plug-in icon in any rack view to open that plug-in window in Zoom view.

 *VENUE provides other ways to jump to a plug-in view. For more information, see “Jump To” Plug-Ins” on page 163.*

Mini-View Mode

Mini-view mode is an option available in Full and Zoom modes in which the rack slot displays are minimized and plug-in icons are hidden, to let you see more of the racks at one time. You can still bypass, route, and work with plug-in snapshot controls in Mini-view mode.

To toggle mini-view on or off:

- Click the Mini-view icon (upper left corner of the rack view).

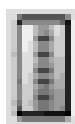

Mini-view

Identifying Rack Slots

The racks indicate which plug-in is currently targeted by highlighting its rack slot controls in blue.

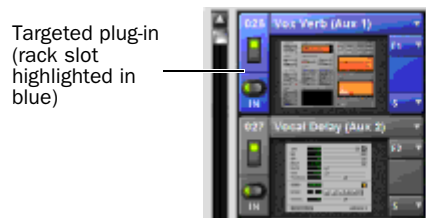

Highlighted rack slot indicating targeted plug-in

Within each rack slot, color outlines appear around each plug-in to indicate the type of plug-in currently targeted on the control surface. The following colors are used:

Outline Color Coding of Rack Slots

Color Outline	Indication
Green	An EQ plug-in is mapped to the console
Blue	A Comp/Lim plug-in is mapped to the console
Yellow	An Exp/Gate plug-in is mapped to the console
Red	A plug-in is mapped to the Assignable Output Encoders (Insert mode)

Display of Unavailable or Inactive Plug-Ins

It is possible for a plug-in to be displayed in a rack slot but be unavailable for channel and bus processing. This can occur in any of the following circumstances:

- There is not enough DSP available for the plug-in.
- The assigned plug-in is part of the show file but is not installed on the current system.
- The plug-in has been disabled manually.

Unavailable Plug-Ins

When a plug-in cannot be used due to insufficient DSP resources, because it is disabled, or because it is not installed, a warning icon appears in front of that plug-in. The plug-in icon is dimmed, and the rack slot Power switch has a yellow LED.



Unavailable plug-in

Indication of an unavailable plug-in

For more information, see “Installing and Authorizing Plug-Ins” on page 151.

Inactive Plug-Ins

When a plug-in has been manually made inactive, the plug-in icon is greyed out. Plug-Ins can be made inactive manually, letting you retain their assignment and settings in the rack while freeing up their DSP resources for other tasks.

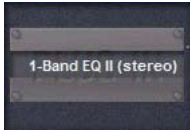

Indication of an inactive plug-in

For more information, see “Active and Inactive Plug-Ins” on page 160.

Scope Indication in the Plug-Ins Page

The Plug-In Rack provides visual indication whenever a plug-in is scoped in the currently targeted snapshot. The Snapshot pop-up menu turns red whenever that plug-in is scoped by the currently targeted snapshot.



Scoped (Snapshot menu red)

Indication of a scoped plug-in

For more information, see “Plug-In Presets and Snapshots” on page 164.

Rack Slots

Each rack provides 25 plug-in slots. You can assign any installed plug-in to any available rack slot.

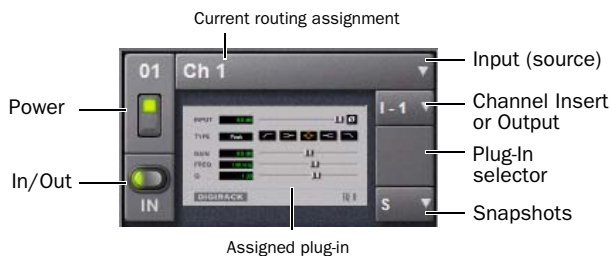

A rack slot and its controls, with an assigned plug-in shown

Each rack slot provides the following controls to select and manage plug-ins:

Power (Config Mode Only)

Power turns the rack slot on or off. When off, the plug-in consumes no DSP.

In/Out (bypass)

The In/Out switch takes the rack slot in or out of circuit (bypasses the slot and any plug-in assigned to it).

Input

The Input pop-up menu determines plug-in input (source). Use this menu to designate the plug-in as a channel insert or a bus processor by choosing from the Inserts or Bus sub-menus. For more information, see “Routing Plug-Ins” on page 160.

Once a plug-in has been routed, its input source is displayed in the Input area of each rack slot, as follows:

- If the plug-in is being used as an insert, the channel or bus name and number is shown, for example, *Kick (Ch 1)* or *Aux 1 (1–2)*. The Channel Insert/Bus Output selector automatically switches to Channel Insert mode, showing the insert point occupied by the plug-in.
- If the plug-in is on a bus, the selected bus source is shown in the Input selector, for example, *Aux 1* or *Grp 1*. The Channel Insert/Bus Output selector can be used to assign the output routing of the plug-in to a channel or bus.

Channel Insert or Bus Output

The Channel Insert/Bus Output pop-up menu displays different choices depending on whether the plug-in is being used as a channel insert, or as a bus processor, as follows:

- If the plug-in is being used as a channel insert, the Channel Insert selector shows the four insert points on that channel (1–4). The letter “I” is shown before the insert number (for example, I-1 indicates the current plug-in is inserted into the first insert position on its channel).
- If the plug-in is being used as a bus processor, the menu becomes the Output selector used to select the destination for plug-in output.



Channel Insert

Bus Output

A mono plug-in inserted on a channel (at left) and a stereo plug-in assigned as a bus processor (at right)

Plug-In Selector

The Plug-In selector displays a list of available plug-ins to load into that rack slot. Plug-Ins are arranged by process type (such as EQ, Dynamics, and Delay). For more information, see “Assigning and Routing Plug-Ins” on page 159.

Snapshots Menu

The Snapshots menu provides tools to manage snapshot-related plug-in features from within the Plug-Ins screen. Using the Snapshots menu, you can quickly check to see which existing snapshots refer to the current plug-in, as well as create, update, or remove snapshots.

Side-Chain Selector

The Side-Chain selector appears near the top of the Rack view when you select a plug-in that supports side-chain or “key” input. In Config mode, the Side-Chain selector lets you establish a side-chain routing to the plug-in. Once established, you can route and re-route side-chain signals in both Config and Show mode. For more information about side-chain signals, see “Side-Chain Routing” on page 161.

Assigning and Routing Plug-Ins

Before you can use a plug-in as a channel insert or bus processor the plug-in must be assigned to a rack slot.

 Before a plug-in can be assigned, it must be installed. See “Installing and Authorizing Plug-Ins” on page 151.

Assigning Plug-Ins to Rack Slots

To assign a plug-in:

- 1 Put the system into Config mode.
- 2 Go to the Plug-Ins page.
- 3 Click the Plug-In selector on an empty rack slot (or on an already assigned rack slot to change a plug-in assignment.)
- 4 Choose an available plug-in from the Plug-In selector sub-menus. Only plug-ins that are installed will be available.



Plug-In selector menus

If the plug-in is not installed or there are insufficient DSP resources available, the plug-in will appear as unavailable, or inactive.

 Place the cursor over the plug-in to display a Tool Tip that explains why the plug-in is unavailable or inactive.

Plug-In Formats

Plug-Ins inserted on channels must be symmetrical (in other words, mono in/out or stereo in/out). Plug-Ins on busses can be asymmetrical (mono-in/stereo or multichannel out).

Mono Can be used as inserts only in mono strips or mono Auxes, mono Groups, or Matrix busses or on the C/M bus.

Stereo Can be used as inserts in stereo strips, stereo-linked Auxes, stereo Groups, PQ busses (which are always stereo) and across the L–R busses.

Other (Mono In/Stereo Out) Can be used on busses for delay, reverb, and similar processing.

Moving and Copying Plug-Ins

(Config Mode Only)

To move or copy a plug-in in the rack, drag the plug-in icon to a new rack slot. A pop-up menu appears offering three choices: Cancel, Copy Plug-In Here, or Move Plug-In Here.

Moving a Plug-In

When you move a plug-in from one rack slot to another, the plug-in type, in/out state, power on/off, current plug-in settings, and routing are maintained. In addition, all associated snapshots are updated to reflect the new rack position.

Copying a Plug-In

When you copy a plug-in to a new rack slot, the source plug-in type, in-circuit state, active state, and current plug-in settings are copied to the destination rack slot. However, the source plug-in routing is not copied. In addition, plug-in snapshots are not copied.

Overwriting An Existing Plug-In

When either moving or copying, if there is an existing plug-in in the destination rack slot, that plug-in is deleted. When the plug-in in the destination rack is deleted, any routing or references to the deleted plug-in in existing snapshots will be automatically cleared.

Active and Inactive Plug-Ins

To toggle the active/inactive state of a plug-in:

- Click the appropriate rack slot Power switch. When active, the Power switch is lit green. When a plug-in is unavailable (and inactive), the Power switch is lit yellow.



Indication of an inactive plug-in

Routing Plug-Ins

After a plug-in has been assigned to a rack slot, you can specify its routing. Plug-In routing determines whether the plug-in is used as a channel insert or as a bus processor.

Using Plug-Ins as Channel Inserts

Each channel provides four slots for channel inserts. Signal from the channel is routed to the insert and returned to the same channel. You can assign plug-ins to specific channel insert points from the Plug-Ins screen or from the Input screen.

To insert a plug-in on a channel from the Inputs or Outputs page:

- Go to the Input or Output screen.
- Click the first available Channel Insert selector and choose an available plug-in from the rack sub-menus. All currently available plug-ins of a compatible mono/stereo format are listed in the sub-menus. Plug-Ins that are unavailable are listed in *italics*. Plug-Ins that are already assigned as channel inserts are shown with their insert assignment.

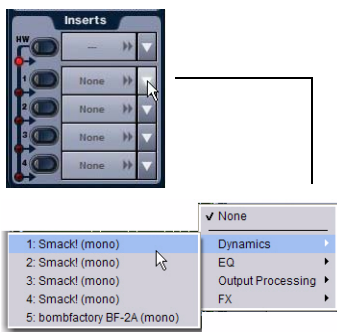

Clicking the Channel Insert selector (top)

- The plug-in appears in the Inserts list for that channel.
- To open the window for an inserted plug-in, click its name in the channel Inserts list.

To insert a plug-in on a channel from the Plug-Ins page:

- Make sure the plug-in is already assigned to a rack slot. (See “Assigning and Routing Plug-Ins” on page 159.)
- Click the Input (source) selector in the rack slot and choose a channel from its Inserts sub-menu.

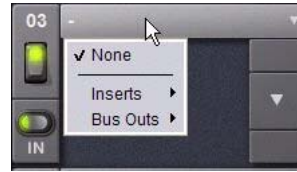

Inserting a rack slot on a channel from the Plug-Ins page

The rack slot automatically identifies and connects to the first available insert slot (1–4) on the selected channel. The Channel Insert selector shows the current insert position.



Channel Insert selector for a plug-in rack

If no insert slots are available on the channel, the selector displays a question mark.

Using Plug-Ins as a Bus Processor

Plug-Ins can be used on busses for send-and-return processing with effects such as reverb and delay. A plug-in is configured for bus processing by assigning an Aux, Group, Matrix, PQ or Mains bus (including Monitor output), or an input channel Direct Out, as the plug-in input source, then assigning the output of the plug-in to an input channel or FX return, or to a hardware output, as follows:

- Return bus-fed plug-ins to an input or FX Return to establish an effects send-and-return path.
- Route bus-fed plug-ins to a hardware output for specialized processing needs (such as feeding an external crossover).

You assign plug-ins for bus processing in the Plug-Ins screen.

To use a plug-in as a bus processor:

- Go to the Plug-Ins screen.
- Make sure the plug-in is installed and assigned to a rack slot.



A plug-in assigned to a rack slot

3 Click the Plug-In Input selector at the top of the corresponding rack slot, and choose an available bus from the Input sub-menus.

Plug-in Input selector



Assigning plug-in Input source to a Group bus

4 Click the Plug-In Output selector and choose a destination channel or bus.

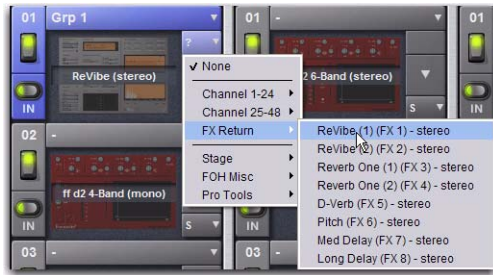

Assigning plug-in output

When a bus-fed plug-in has both its input source and output assigned, it appears similar to the following in the rack:



A bus-fed plug-in in the rack

Routing Channel Direct Outs to Plug-Ins

You can route input channel Direct Outs to plug-ins. This lets you directly feed plug-ins from individual channels to preserve Aux busses for other uses, with control over send level using the channel Direct Out level control.



Assigning a channel Direct Out as a plug-in input source in the Plug-Ins page

When a channel Direct Out is routed to a plug-in, it follows the one global pickoff setting for that specific Direct Out (as set in the Patchbay), and is applied in addition to any other assignment made for that Direct Out. This makes it possible to use a channel's Direct Out to route that channel to both a Pro Tools recording option and to a plug-in.

Side-Chain Routing

VENUE systems support side-chain (key) processing for plug-ins that support side-chain triggering.

⚠ Side-chain routing is not stored in snapshots.

The Side-Chain selectors appear across the top of the plug-ins screen. You must be in Config mode to establish or remove a side-chain assignment. Once established, side-chain routing can be changed (but not added or removed) in Show mode.



Click to select Key (side-chain) source
Click to specify side-chain pickoff

Side-Chain controls

To assign side-chain routing to a plug-in:

- 1 Select a plug-in that supports side-chain processing.
- 2 Put the system into Config mode to display the Side-chain tools.
- 3 Choose the side-chain source signal from the Key Source pop-up menu.
- 4 Choose the pickoff point (tap) for the side-chain signal from the Source Pickoff pop-up menu.

Adjusting Plug-Ins

Plug-Ins can be selected and adjusted from the console or on-screen.

On the Console

The VENUE D-Show Main Unit provides plug-in controls in the ACS and in the Assignable Output Encoder sections for real-time interaction with plug-ins.

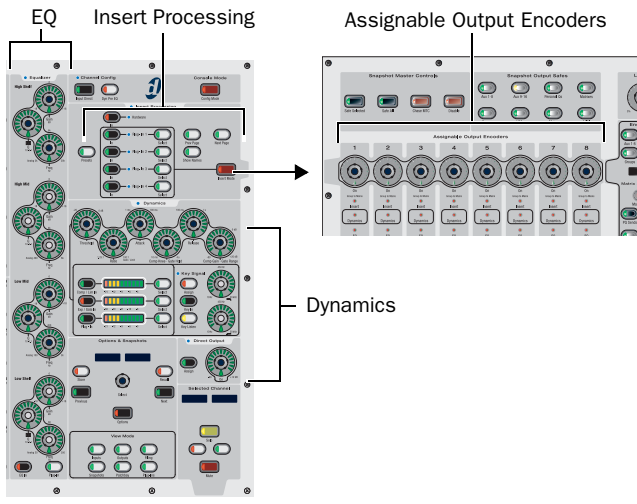

Plug-In controls on the control surface

Insert Processing

The Insert Processing section of the ACS lets you bypass, select, and target plug-ins inserted on the currently selected channel.

Dynamics

Dynamics plug-ins can be selected and adjusted in the Dynamics section in the ACS. (Dynamics and EQ plug-ins can be targeted on the ACS and Output encoders simultaneously).

EQ

EQ plug-ins can be selected and adjusted with the controls in the EQ section in the ACS. (EQ and Dynamics plug-ins can be targeted on the Output encoders and ACS simultaneously).

Output Encoders

The Output encoders can be placed into Insert mode to adjust any selected plug-in. Plug-in parameters map to the eight encoders and their switches; additional parameters are accessed with the Previous Page and Next Page switches.

To adjust a plug-in from the console:

- 1 Select the channel or bus on which the plug-in is inserted. To select a bus processing plug-in, bank to and select the FX Return or other channel assigned as the plug-in output.
- 2 In the Insert Processing section of the ACS, press the Select switch for the plug-in so that its switch is lit.
- 3 Press the Insert Mode switch, located near the Output encoders. The first page of plug-in parameters is mapped to the eight Output encoders.
- 4 To reset a parameter to its default value, hold the Alt key while rotating or pushing an encoder.
- 5 To adjust with greater resolution, hold the Ctrl key while rotating an encoder.
- 6 Press Previous Page or Next Page to bank to other plug-in parameters.

Display of Plug-Ins in Insert Mode

While in Insert Mode, the Output LCD displays the value and name of the 8 currently banked plug-in parameters in the upper and lower row, respectively, for each parameter.

In this default Insert Mode view, adjusting an Output fader temporarily shows fader level in the lower row of the Output LCD for that channel, replacing the parameter name display.

Alternate Insert Mode View

You can use an alternate view to have Insert Mode display parameter values in the upper row and the associated bus name in the lower row.

To view values and bus names for the Output encoders in Insert Mode:

- Press Default/Alt+Insert Mode.

Using the Source Switch

The Source switch toggles Input displays to show the names of bus-fed plug-ins routed to a channel. Use the Source switch to quickly identify which FX Returns or other channels are being used as plug-in returns.

To view encoder values and bus names for Input or FX Return channels:

- Press the Source switch, located in the Display section to the left of the input Mute/Solo/Select switches.

Bypassing Plug-Ins

To bypass a plug-in from the console:

- 1 Select the channel on which the plug-in is inserted.
- 2 In the Insert Processing section of the ACS, press the In/Out switch for the plug-in to toggle it in-circuit/out-of-circuit. When the switch LED is lit, the plug-in is in-circuit. When unlit, the plug-in is out-of-circuit (bypassed).

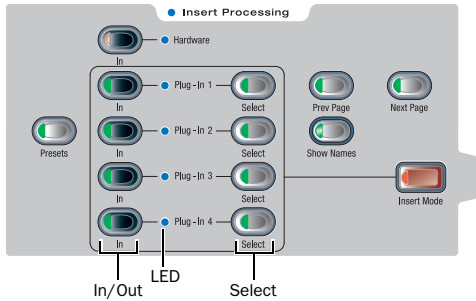

Insert Processing section

To bypass a plug-in on-screen:

- 1 Select the channel on which the plug-in is inserted.
- 2 In the Inserts section of the Inputs or Outputs page, click the In/Out switch for the plug-in to toggle it in-circuit/out-of-circuit. When lit, the plug-in is in-circuit. When unlit, the plug-in is out-of-circuit (bypassed).

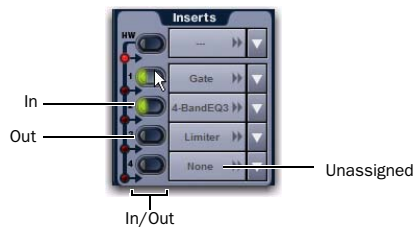

LED indication of in circuit and out of circuit (bypassed) inserts

Plug-ins On-Screen

The software screen can be used to patch, route, or re-route plug-ins during a performance, even while in Show mode.

 *Plug-Ins must be installed on the system and assigned to a rack slot to be available while mixing. See “Assigning Plug-Ins to Rack Slots” on page 159.*

“Jump To” Plug-Ins

The Input and Output screens let you “jump to” a specific plug-in insert to adjust it on-screen.

To jump to a plug-in insert from the Inputs or Outputs screen:

- 1 Select a channel to show it in the Inputs or Outputs page.
- 2 Click the plug-in name shown in the channel Insert section.



Jumping to a plug-in on a channel insert

To jump to a plug-in on a bus:

- 1 Bank to the FX Return or other channel type assigned as the plug-in output, or bank to the output feeding the plug-in.
- 2 Select the channel to display it in the Inputs or Outputs screen.
- 3 Click the routing displayed beneath the Channel Name.



Jumping to a plug-in on an FX Return

Plug-In Screens and Channel Selection

When jumping to a plug-in, display depends on the type of plug-in routing, as follows:

Channel Inserts If the Plug-Ins screen is in Zoom view while you select a channel, the last selected plug-in for that channel is automatically selected and displayed in the Plug-Ins screen.

Bus-Fed Plug-Ins If no plug-ins are inserted on a channel (such as when returning a bus-fed plug-in to an FX Return) the plug-in feeding that FX Return is displayed.

Pinning a Plug-In View

It is possible to decouple the plug-in view from the console for consistent and constant access to a single plug-in on-screen, while still being able to select and adjust other plug-ins from the console. This capability is useful any time you want to always display an important plug-in (such as an analysis plug-in or primary EQ).

To pin a plug-in view:

- 1 Bring the desired plug-in into the main plug-in view (use the channel Select and Insert Mode switches, or double-click the desired plug-in in the rack).
- 2 Click the Push-Pin icon in the upper-right of the screen (the icon is located just to the left of the Presets and View Toggle icons).
 - When enabled, the Push-Pin icon appears lit. This indicates that the current plug-in will remain on-screen and will not lose focus, even if another channel is targeted.
 - When not enabled, the Push-Pin icon appears unlit. Plug-in view follows control surface selections.



Push-Pin plug-in view icon

Plug-In Presets and Snapshots

You can save and load plug-in Presets files to import, export, and transfer plug-in settings files.

Snapshots can also be used to automate changes to plug-in routing and settings.



Presets can be applied to multiple Shows, while snapshots apply only to the Show file in which they are stored.

Presets

Presets are files that you can create to save, load, archive and transfer custom plug-in settings. You can then create your own Preset folders to organize Preset files. Preset folders and files can be transferred using the Filing Page.

To create a custom Presets folder:

- 1 Go to the Filing page and click the Transfer tab.
- 2 Click the Preset Folders icon.
- 3 Click the New button at the left of the screen.
- 4 Do one of the following:
 - To leave the folder at its default name, press Enter.
 - or –
 - Type a new name and press Enter.

To save a Preset:

- 1 Adjust the plug-in parameters as desired.
- 2 Click the Presets icon in the Plug-Ins screen.
- 3 In the Presets window, click New.
- 4 Enter a custom name for the Preset.

To load a Preset into a plug-in:

- 1 Make sure the presets are already transferred and available on the current system. (Many plug-ins come with factory presets that will be installed along with the plug-in.)
- 2 Select the channel containing the plug-in, and target the desired plug-in (press the Insert Mode switch, or click the plug-in on-screen).
- 3 Click the Presets icon in the Plug-Ins screen.
- 4 Single-click a preset name in the Presets list to preview it. With the Presets list displayed, do any of the following:
 - To scroll through the list, press Up or Down arrow keys on your computer keyboard.
 - To load a preset and close the Presets list, double-click a name in the Presets list.
 - Click Cancel to close the Presets list without changing settings.

Snapshots

Snapshots can automate plug-in settings, including routing, and in/out state. (Side-chain routing is not supported in Snapshots.)

Snapshots can also store and recall tempo, to synchronize delay and echo plug-ins that support Tempo Sync.



Snapshots do not store or recall Presets. Snapshots store plug-in settings at the time the Snapshot is created or saved.

Each rack slot in the Plug-Ins screen provides a Snapshot menu, with shortcuts for common snapshot-related tasks:

- Create a new snapshot
- Add one or more plug-ins to the MIDI/Plug-Ins list, and automatically re-scope the snapshot to include plug-ins
- Remove plug-ins from one or more snapshots

Snapshots Containing this Plug-In Lists all currently loaded snapshots referencing the plug-in, in sequential order. Choose a snapshot to load it. (This menu option is useful for targeting snapshots while editing plug-in racks.)

Create New Snapshot Containing this Plug-In Adds a new snapshot to the snapshot list in which only plug-ins are scoped. This snapshot is inserted immediately after the currently targeted snapshot, which may not necessarily be the last snapshot. The snapshot is named to reflect the plug-in rack position, for example: “PI 1-1: Reverb One” is a Reverb One plug-in assigned to rack 1, slot 1.

Add (or Update) this Plug-In to Snapshot Adds a plug-in reference, with current settings, if the currently targeted snapshot does not already reference this plug-in. If the currently targeted snapshot already references this plug-in, the choice is Update (see next). If multiple snapshots are selected, this command changes to “Add Plug-In to Selected Snapshots” for batch-assignment.

Update this Plug-In in Snapshots Updates snapshots with current settings, if the currently targeted snapshot (or currently selected snapshots) already references this plug-in.

Remove this Plug-In in Snapshot Removes reference to this plug-in in the currently targeted snapshot, or from all currently selected snapshots.

 See Chapter 21, “Snapshots.”

Plug-Ins and VENUE D-Show Standalone Software

You can use VENUE D-Show Standalone software to preconfigure plug-in routing and in/out state, with the following limitations:

- Plug-Ins cannot be installed in the Standalone Software.
- A Show file must be transferred from a console on which plug-ins were previously installed.

Once a Show file containing plug-ins has been transferred to the standalone software, the following rules apply:

- Plug-Ins can be placed in racks and routed in Standalone mode.
- Snapshots can be created, loaded, and stored.
- Plug-In settings cannot be adjusted.
- Plug-In Presets cannot be saved or loaded.

Plug-In DSP Usage

Plug-Ins utilize DSP resources when they are assigned to a rack slot, and that rack slot is powered on. You can turn off unused plug-ins to reclaim their DSP by making them inactive, or by removing them from the system.

Plug-In availability is limited to the available DSP resources.

The amount of DSP available for plug-ins also varies with the current system configuration settings for Input Channels, FX Returns, and graphic EQs. Higher number of Input Channels leave fewer DSP resources for plug-ins, as shown in the Options > System Config screen.

Initializing the Plug-In Racks

The racks are initialized (or re-initialized) whenever the system is first powered on, whenever the FOH Rack is restarted, after installing a plug-in, and after disabling or re-enabling a plug-in.

While the racks are initializing, they are offline and do not process audio. Avoid performing any Filing or Transfer functions until the racks are finished initializing. Rack status is displayed on-screen in the banner display.

Plug-In Levels

VENUE systems display levels in meters in dBVU, with 0 dBVU = +4dBu analog out = -20dBFS.

Internally, VENUE systems provide up to 48-bit processing for built-in EQ and dynamics. Plug-Ins provide up to 24-bit processing, with level matching circuitry and logic ensuring maximum fidelity and sonic performance throughout the entire signal path. Due to variances in how plug-in metering is implemented by different manufacturers, performance may vary with regard to plug-in gain reduction meters and their relative levels.

When using side-chain routing, be aware of potential level differences between Input Channel pickoff points. For more information, see “Side-Chain Keys and Filters” on page 141.

Plug-In Latency and Processing Delay

Plug-In latency includes processing delay of the plug-in itself plus routing delay, as follows:

- Instance delay: 2 samples per plug-in
- DSP routing delay: 3 samples

Viewing Plug-In Latency

Cumulative channel processing delay can be viewed by right-clicking the Inserts area of the selected channel. The cumulative delay includes latency reported by all inserted plug-ins, signal routing and the known hardware insert delay, if applicable.

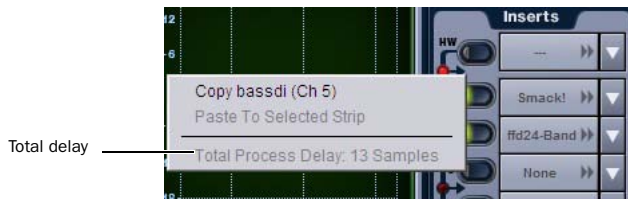

Viewing cumulative delay by right-clicking the Inserts section

Individual plug-In processing delay can be seen by right-clicking the plug-in icon in the rack. Use the number reported when calculating latency for manual delay compensation.

Examples

If there is only one plug-in on a channel, the total delay will be the amount of plug-in latency + 2 + 3. (2 samples for the one plug-in instance, plus 3 samples for the DSP routing to the racks and back.)

If you have two plug-ins on a channel or bus, the delay will be plug-in #1 latency + 2 + plug-in #2 latency + 2 + 3. If plug-in #1 has 12 samples of latency, and plug-in #2 has 15, total latency will be 34 samples (12 + 2 + 15 + 2 + 3).

Chapter 19: Hardware Inserts

FOH Rack (and Mix Rack FOH I/O) let you route signals to and from external devices as hardware inserts. Hardware inserts can be used on input channels, FX returns, Groups, Auxes, Matrixes, Personal Qs, and Mains.

FOH Racks (and Mix Racks) provide 8 analog hardware insert channels. Up to 16 analog and 8 digital hardware inserts can be used with an expanded FOH Rack (requires an I/Ox expansion option).

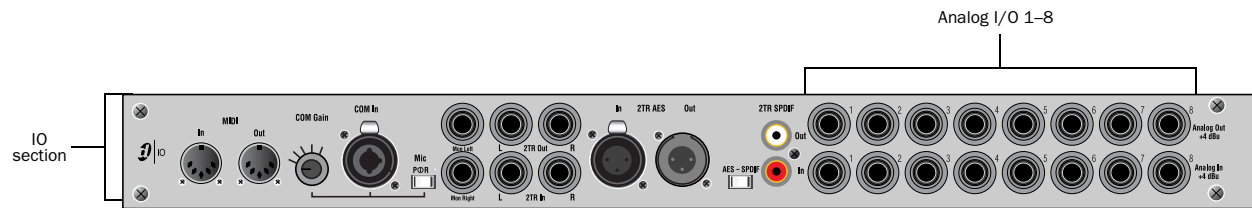

Figure 12. Hardware insert patch points on Mix Rack and FOH Rack, showing standard mix position (FOH) I/O connectors

Connecting External Effects Units

Outboard gear is made available to the system by connecting its inputs and outputs to connectors in the FOH I/O sections of the FOH Rack or Mix Rack. Hardware inserts can then be assigned on channels similarly to inserting plug-ins.

To connect outboard gear for use as a hardware insert:

- 1 Connect the external device inputs to analog or digital Out connectors (Analog 1–8, Analog 9–16, or AES 1–8) on the Mix Rack or FOH Rack.
- 2 Connect the external device outputs to the corresponding In connectors on the back panel of the Mix Rack or FOH Rack. For example, signal taken from FOH Output 1 returns on FOH Input 1.

Assigning Hardware Inserts to Channels

You can assign hardware inserts directly from the Inputs page or Outputs page. You can also make hardware insert assignments from the Patchbay.

 For complete instructions, see Chapter 12, “Patchbay.”

To assign a hardware insert to a channel or bus:

- 1 Go to the Inputs or the Outputs page and target the channel where you want to assign the hardware insert by pressing the channel Select switch.

- 2 In the Inserts section, do one of the following:

- Click the Hardware Insert pop-up menu and choose an insert destination directly from the menu. The name of the hardware insert destination appears in the on-screen Hardware Insert button.
- or –
- Click the Hardware Insert button to go to the Inserts page of the Patchbay, and assign the insert from the Patchbay.

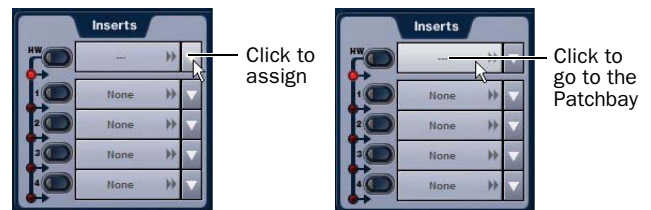

Assigning a hardware insert in the Outputs page

To assign a hardware insert from the Patchbay:

- 1 Go to the Patchbay and click the Inserts tab. The Hardware Tab for the Mix Rack or FOH Rack is shown.
- 2 Click the Channels, FX Returns, or Outputs tabs to show the desired channel types in the grid. If you jumped to the patchbay from the Inputs or Outputs page, the appropriate Channel Type tabs are automatically enabled.

3 Click in the channel grid to assign the insert input/output number (listed across the top) to the channel where you want to assign the insert (listed on the left).



Assigning a hardware insert in the Patchbay Inserts page

The Patchbay Inserts tab shows the name of the channel and its destination at the current cursor location. The Insert location is also displayed in the Inserts section in the Inputs or Outputs page.

Setting the Hardware Insert Location

You can choose the location of the hardware insert in the signal path relative to the four plug-in inserts, for each channel.

To set the hardware insert location:

- 1 Go to the Outputs page and select the channel where you want to set the hardware insert location.
- 2 In the Inserts section of the Outputs page, click the hardware insert indicator so that it lights red.

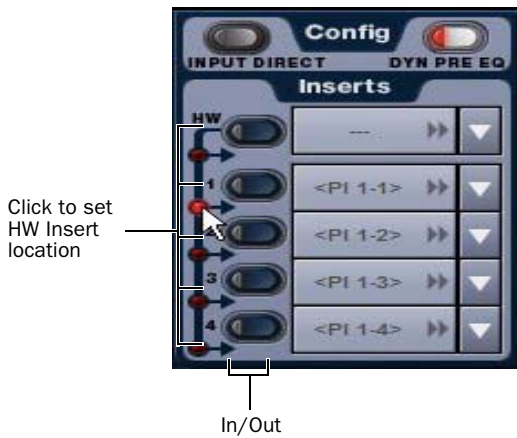

Setting a hardware insert location in the Inputs page

Activating and Bypassing Hardware Inserts

You can toggle hardware inserts in/out from the Input section or ACS (on the console), or on-screen.

To activate or bypass a hardware insert from the input section:

- Press the Hardware Insert In switch on the channel. The switch lights when the insert is activated.

To activate or bypass a hardware insert from the ACS:

- 1 Select the channel where you want to activate or bypass the insert.
- 2 Press the Hardware switch in the Insert Processing section.

To activate or bypass a hardware insert on-screen.

- 1 Target the channel where you want to activate or bypass the insert by pressing the channel Select switch.
- 2 Click the In/Out button for the HW insert. The button lights when the insert is activated (in circuit).

Part V: Shows

Chapter 20: Shows and File Management

Data can be stored, recalled and transferred between VENUE systems. There are three types of information files that can be managed separately, as follows:

Show Files These files are used to store, recall and transfer system settings, snapshot, and events.

Preset Files These files are used to store settings for channel strips, built-in processors and plug-ins, and Recall Safe Scope Sets.

Console Setting Files These files are used to transfer or back up the current state of the VENUE system.

! *The system does not need to be in Config mode to carry out file management tasks. However, many file management operations, including loading Shows, may interrupt audio throughput. Make sure to perform all file management tasks before a performance.*

Creating Shows

A Show file contains all configuration, signal routing, mixer settings, plug-in information, snapshots, and other operational settings. Shows are grouped together in Show Folders.

Show Folders

Show Folders contain Show files. You can create and manage Show Folders from the Save tab of the Filing page.

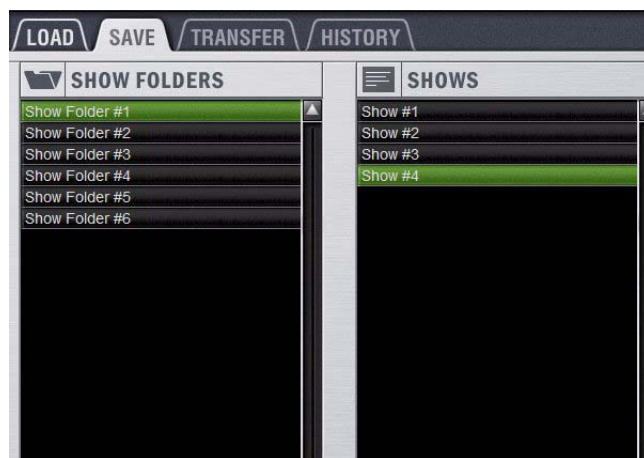

Show Folders and Show files in the Save tab of the Filing page

Creating Show Folders

To create a new Show Folder:

- 1 Go to the Filing page and click the Save tab.
- 2 In the Show Folders column, click the New button.
- 3 Type a name for the Show Folder and press Enter.

Duplicating Show Folders

To duplicate a Show Folders:

- 1 In the Show Folders column, click a Show Folder name to select the folder.
- 2 Click the Duplicate button.

The folder and all of the Show files it contains are duplicated.

! *You can also duplicate folders by right-clicking a Show Folder name and choosing Duplicate.*

Renaming Show Folders

To rename a Show Folder:

- 1 In the Show Folders column, click a Show Folder name to select the folder.
- 2 Click the Rename button.

! *You can also rename Show Folders by right-clicking a Show Folder name and choosing Rename, or by double-clicking a Show Folder name.*

- 3 Type a new name for the Show Folder and press Enter.

Deleting Show Folders

When you delete a Show Folder, all Show files contained in that folder are also deleted.

To delete a Show Folder:

- 1 In the Show Folders column, click a Show Folder name to select the folder.
- 2 Click the Delete button.

! *You can also right-click a Show Folder name and choose Delete to delete the folder.*

Show Files

Creating and Saving Show Files

When you create a new Show file, it captures the current state of the system. Show files are automatically saved when they are created or overwritten.

To create a new Show file:

- 1 Go to the Filing page and click the Save tab.
- 2 In the Show Folders column, select the Show folder where you want to save the Show.
- 3 In the Shows column, click the New button. The new Show file captures the current state of the system.
- 4 Type a name for the Show file and press Enter.
- 5 Double-click in the Notes field for the Show and type any comments you want to save with the Show.

Information about the Show file is shown in the Info area of the Filing page.

 *Show files are automatically saved when they are created; no further action is required to save them.*

To update or overwrite an existing Show file:

- In the Shows column, right-click the Show file name you want to overwrite, and choose Overwrite from the pop-up menu. The current state of the system is saved to the selected Show file.



Right-clicking a Show file name in the Shows column

Duplicating Show Files

To duplicate a Show file:

- 1 In the Shows column, click a Show file name to select it.
- 2 In the Shows column, click the Duplicate button.

 *You can also right-click a Show file name and choose Duplicate to duplicate the file.*

Renaming Show Files

To rename a Show file:

- 1 In the Shows column, click a Show file name to select it.
- 2 In the Shows column, click the Rename button.

 *You can also right-click a Show file name and choose Rename, or double-click the Show file name to rename the file.*

- 3 Type a new name for the Show file and press Enter.

Deleting Show Files

To delete a Show file:

- 1 In the Shows column, click a Show file name to select it.
- 2 In the Shows column, click the Delete button.

 *You can also right-click a Show file name and choose Delete to delete the file.*

Loading Shows

You can load Show files using the Load tab of the Filing page.

Shows cannot be loaded onto the destination VENUE system directly from a portable storage device; they must first be transferred to the system before loading.

 *Loading a show automatically replaces the current console settings with those of the loaded show, and may interrupt audio throughput.*



Show Folders and Show files in the Load tab of the Filing Page

To load a Show file:

- 1 Go to the Filing page and click the Load tab.
- 2 In the Show Folders column, click a Show Folder name to select the folder. Any Show files in the folder are displayed in the Shows column.
- 3 In the Shows column, click a Show file name to select it.
- 4 Click the Load button.

The system loads the new Show file, replacing the current system configuration, routing, and control settings with those contained in the new file.

System Configurations and Loading Shows

Show files include VENUE system configuration settings (such as the type of console (VENUE D-Show Main and Sidecars, or VENUE Profile), as well as System Configuration and other settings in the Options > System tab.

- If a Show file includes the same system configuration settings as the current configuration, the configuration information appears in blue text in the Info area.
- If a Show file differs from the current configuration, but can be loaded on the system, the relevant configuration changes appear in orange text in the Info area. When the Show file is loaded, the system restarts in the new configuration.
- If a Show file differs from the current configuration and cannot be loaded on the system in its entirety, the configuration information appears in red text in the Info area.
- Plug-in status is reviewed:
 - Plug-ins that have been removed (uninstalled) no longer appear in menus and lists.
 - Plug-in versions are checked for compatibility with the current system.

 For more information on plug-in management, see “Managing Plug-Ins on the System” on page 153.

If a Show configuration is too large for the current system, mix elements are dropped in the following order:

- 1 Plug-Ins are deactivated
- 2 Graphics EQs are dropped
- 3 Input Channels are dropped

Working with Presets

Preset files are used to store, recall and transfer factory or user-defined presets. Preset files are grouped in the following types of Preset Folders:

Built-in 4-band EQ, 31-band Graphic EQ, Compressor/Limiter, Expander/Gate, and Input Channel Presets

Plug-In Plug-ins Settings Files

Scope Sets Settings for Recall Safe configurations

Preset Folders

Preset Folders contain Preset files. Each of the built-in processors (Compressor/Limiter, Expander/Gate, 4-band EQ, 31-band Graphic EQ) and each plug-in has its own Factory Defaults folder. Additional folders are provided for Scope Sets.

You can create additional Preset Folders for each processor or plug-in and store new Presets in them. These folders can then be transferred to a portable storage device for transfer to other VENUE systems.

 For information on saving, previewing and loading built-in dynamics and EQ presets, see Chapter 16, “Dynamics” and Chapter 17, “EQ.” For plug-in settings, see Chapter 18, “Plug-Ins.” For Scope Sets, see Chapter 21, “Snapshots.” For Input Channel Presets, see Chapter 5, “Navigating and Selecting Channels”,

Creating Preset Folders

To create a new Preset Folder:

- 1 Go to the Filing page and click the Transfer tab.
- 2 Click the Preset Folders icon. A list of Preset Folders appears in the left column.



Preset Folders icon in the Transfer tab of the Filing page

- 3 In the left column, click the New button.
- 4 Type a name for the Preset Folder and press Enter.

The new Preset Folder is available in the Preset window for each processor or plug-in.

Duplicating Preset Folders

To duplicate a Preset Folder:

- 1 In the left column, click a Preset Folder name to select it.
- 2 Click the Duplicate button.

The folder and all of the Preset files it contains are duplicated.

 You can also right-click a Preset Folder name and choose Duplicate to duplicate the folder.

Renaming Preset Folders

To rename a Preset Folder:

- 1 In the left column, click a Preset Folder name to select it.
- 2 Click the Rename button.

 You can also right-click a Preset Folder name and choose Rename, or double-click a Preset Folder name to rename the folder.

- 3 Type a new name for the Preset Folder and press Enter.

Deleting Preset Folders

When you delete a Preset Folder, all Presets contained in that folder are also deleted.

To delete a Preset Folder:

- 1 In the left column, click a Preset Folder name to select it.
- 2 Click the Delete button.

 You can also right-click a Preset Folder name and choose *Delete* to delete the folder.

Preset Files

You can manage Preset files from the Transfer tab of the Filing page. You cannot create Preset files from the Filing page. Preset files are created from the Presets window of the channel, processor or plug-in; Scope Sets are created from the Scope Sets window of the Recall Safe page.

Duplicating Presets

To duplicate a Preset file:

- 1 Go to the Filing page and click the Transfer tab.
- 2 Click the Built-In or Plug-In icon and choose a processor or plug-in from the pop-up menu. The available Preset Folders for the processor or plug-in appear in a pop-up menu above the left column.

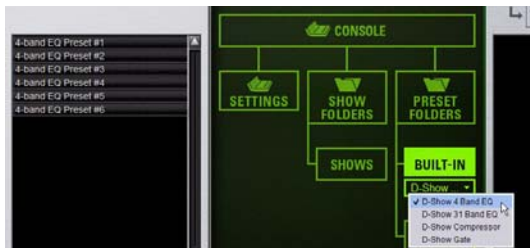

Built-In EQ in the Transfer tab of the Filing Page

- 3 Click the Preset Folder name and choose a Preset Folder from the pop-up menu. Any Presets in the folder appear in the left column.



Preset Folder names at the top of the Presets column

- 4 Click a Preset file name to select the file.
- 5 Click the Duplicate button.

 You can also right-click a Preset file name and choose *Duplicate* to duplicate the Preset.

Renaming Presets

To rename a Preset file:

- 1 In the left column, click a Preset file name to select the file.
- 2 Click the Rename button.

 You can also right-click a Preset file name and choose *Rename*, or double-click a Preset file name to rename the Preset.

- 3 Type a new name for the Preset file and press Enter.

Deleting Presets

To delete a Preset file:

- 1 In the left column, click a Preset file name to select it.
- 2 Click the Delete button.

 You can also right-click a Preset file name and choose *Delete* to delete the Preset.

Transferring Settings, Shows and Presets

You can copy Console Settings, Shows, and Presets to and from a portable storage device (such as a USB key disk) for backup, transfer from standalone software, and transfer between systems.

Settings, Shows and Presets cannot be loaded onto the destination system directly from the portable storage device, but must first be transferred to the system before loading.

Transfer of Settings files, Show files, and Preset files is managed from the Transfer tab of the Filing page. The Transfer tab shows the system-resident files in the left column and the contents of the portable storage device in the right column. Items are selected for transfer in the center.



File transfer controls

To transfer Settings, Shows or Presets to or from a portable storage device:

- 1 Go to the Filing page and click the Transfer tab.
- 2 Connect a portable storage device (such as a USB key disk) to the system. The device appears above the right column.
- 3 Do one of the following to select the type of data to transfer:
 - To transfer all data, click the Console icon.
 - To transfer Console Settings, click the Settings icon.
 - To transfer Show Folders, click the Show Folders icon.
 - To transfer individual Shows, click the Shows icon.
 - To transfer Preset Folders, click the Preset Folders icon.
 - To transfer Presets for individual items, click the Built-In or Plug-In icon and choose a built-in processor or plug-in, or Input Channel from the pop-up menu.
 - To transfer Scope Sets for Recall Safe, click the Scope Sets icon.



Preparing to transfer items to USB key disk

- 4 Do one of the following to select the items to transfer:
 - In the left column, select the items you want to transfer to the portable storage device.
 - or –
 - In the right column, select the items you want to transfer from the portable storage device to the VENUE system.
- 5 Click the Transfer button.

Large transfers may take time. Transfer status is shown by a progress bar. A transfer may be cancelled by clicking Cancel.

A Cancelled transfers may result in partial folder contents, which will have to be deleted manually.

Synchronizing Settings, Shows and Presets

Instead of transferring data in one direction between the VENUE system and a portable storage device, you can synchronize all data in both columns of the Transfer tab in a single operation.

Synchronizing data causes new files to be copied and files with the same name but a more recent modification date/time to be automatically updated.

A When synchronizing data, the VENUE D-Show software replaces data files of the same name with the file that has the most recent date/time. Check to be sure that the system clock times and time zones are correctly set on the system and on the computer running the Standalone software when preparing data for synchronization.

To synchronize Settings, Shows, or Presets between the VENUE system and a portable storage device:

- 1 Go to the Filing page and click the Transfer tab.
- 2 Connect a portable storage device such as a USB key disk. The device appears above the right column.
- 3 Do one of the following to select the type of data to synchronize:
 - To synchronize all data, click the Console icon.
 - To synchronize Console Settings, click the Settings icon.
 - To synchronize Show Folders, click the Show Folders icon.
 - To synchronize individual Shows, click the Show icon.
 - To synchronize Preset Folders, click the Preset Folders icon.
 - To synchronize Presets for individual items, click the Built-In icon or the Plug-In icon and choose a processor or plug-in from the pop-up menu.
- 4 From the pop-up menus above each column, choose the folders containing the elements you want to synchronize.
- 5 Click the Sync All button. The contents of the left and right columns are synchronized.

 Using the Standalone software on a laptop computer, you can configure VENUE system routing, set up mixes, create Snapshots, and save Shows and Presets. You can then transfer your data to a USB disk for use on a VENUE system. See Chapter 24, "Using the Standalone Software."

Undoing Changes Using the History Feature

The VENUE system automatically saves the current state of the console while you are working, allowing you to quickly return the console to a previous state.

The History feature uses Show files to capture the console state, and displays the files in the History tab.

 Show Folders and Show files displayed in the History tab can only be deleted. They cannot be duplicated or renamed.

Show Folders in the History Tab

There are two Show Folders in the History tab:

- ◆ The *Most Recent Changes* folder includes all auto-saved Show files for a ten-hour period.
- ◆ The *Previous Days* folder includes only the last auto-saved Show file for each day since the console was last cleared.

Show Files in the History Tab

The auto-saved Show files displayed in the History Tab are named according to the date and time of their creation, and cannot be renamed.

The Notes field for each auto-saved Show file includes a description of the conditions that caused the automatic save.

Several conditions cause the system to automatically save a new Show file in the History tab, as follows:

- ◆ In the course of normal work, a new Show file is automatically saved in the History tab approximately every ten minutes. Saves are less frequent when the console is idle.
- ◆ A new Show file is automatically saved just prior to a significant change in the console setup, including:
 - Change of console channel or bus configuration
 - Recall, storage, or modification of a Snapshot
 - Loading of Console Settings or a Show

Loading an Auto-Saved Show

To return the console to an earlier state at any time, you can load any of the auto-saved Show files displayed in the History tab.

To load an auto-saved Show file:

- 1 Go to the Filing page and click the History tab.
- 2 In the Show Folders column, click the Show Folder name to select the folder and display its contents in the Shows column.
- 3 In the Shows column, click the name for the Show you want load.

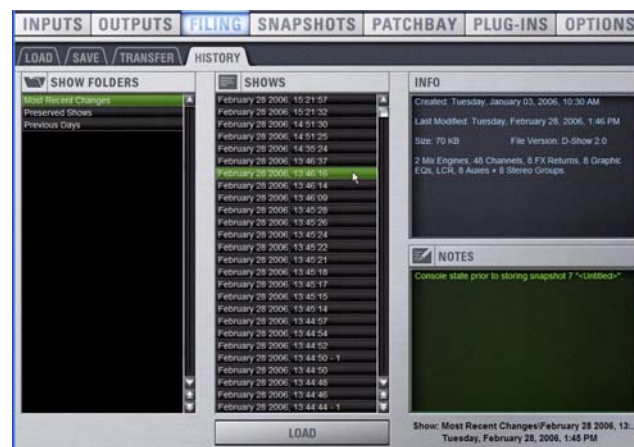

Loading an auto-saved Show file

- 4 Click the Load button.

The VENUE system loads the selected Show file, replacing the current system configuration, routing, and control settings with those contained in the selected file.

Chapter 21: Snapshots

Snapshots let you flexibly store and recall a wide range of mixing parameters. Snapshots are commonly used to store the mixer setup and levels for individual scenes, songs or sound cues in a performance. Snapshots store information about channels and mix parameters, and can also include MTC, tempo, and crossfade instructions.

Snapshots are contained and stored as part of a Show. A single Show file can contain up to 999 snapshots. Snapshots are controlled from the on-screen Snapshots page, or from the Snapshot controls on the console. Once stored, snapshots can be recalled manually or automatically (triggered by events or MTC). Snapshots can also trigger events. The system also provides a variety of methods to edit, preview, and manage snapshot data.

Snapshots Page

The Snapshots page provides controls for storing, recalling, and managing snapshots, providing a central location for setting up and replaying automated performances.

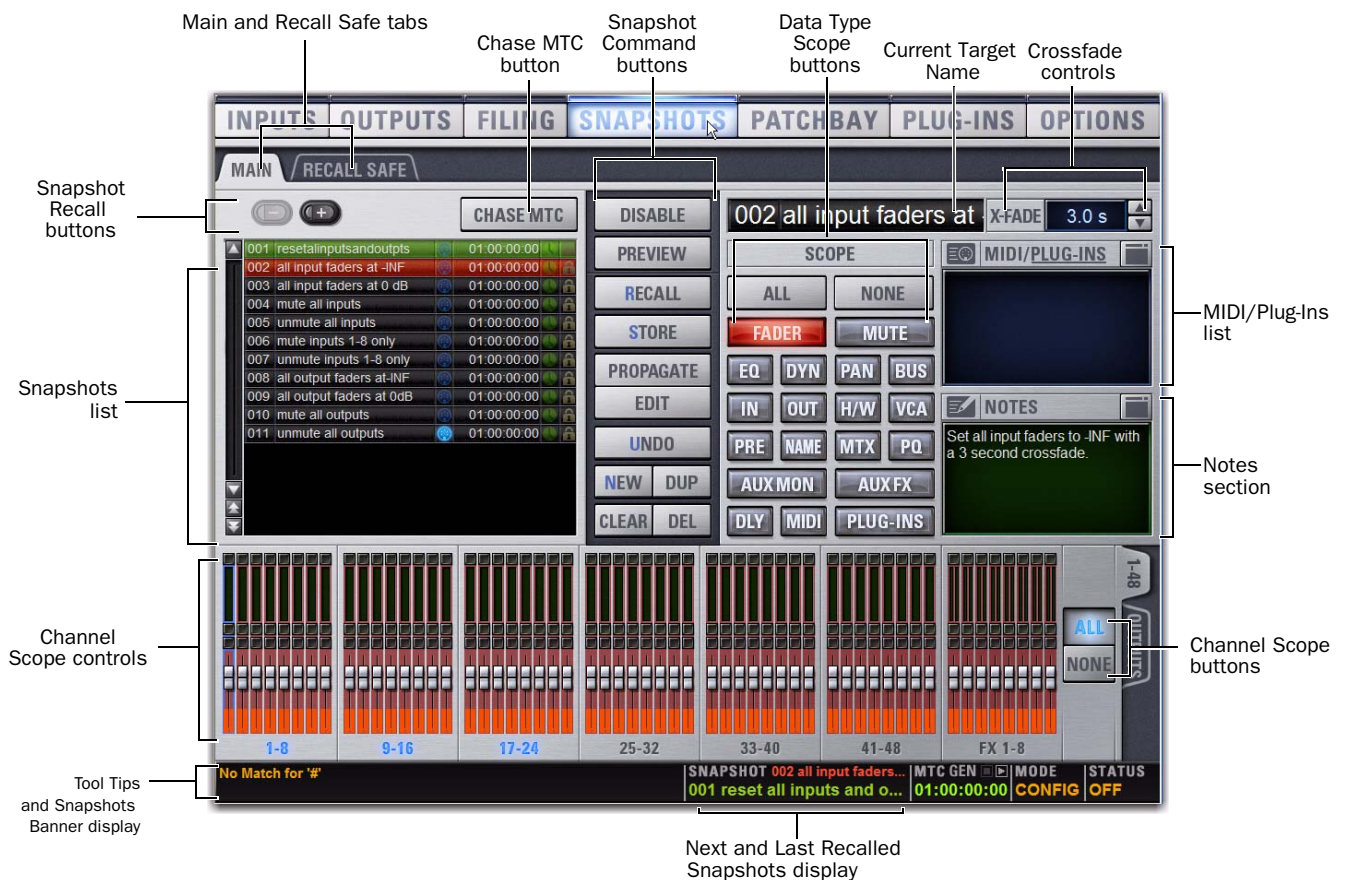

Figure 13. Sections of the Snapshots page

To display the Snapshots page, do one of the following:

- Click the Snapshots tab on-screen.
 - or –
- Press the Snapshots switch in the View Modes section.

 Repeatedly pressing the Snapshots View Mode button toggles between the Main and Recall Safe tabs.

Main and Recall Safe

The Snapshots screen provides the Main and Recall Safe tabs.

Main Provides the primary snapshot controls.

Recall Safe Provides a matrix of channel parameters that can be globally safed (or isolated) from Recall for all snapshots.

Snapshots List

Snapshots can be targeted, renamed, recalled, previewed, edited, locked, reordered, duplicated, searched, and deleted from the Snapshots list.

Snapshot Command Buttons

Disable Temporarily disables all snapshot functions.

Preview An “offline” mode in which the console continues to process audio using its settings at the time Preview is invoked, letting you recall, edit and manage snapshots without affecting the current mix.

Recall Recalls the targeted snapshot, updating the console to reflect the status of all scoped data types and channels in the snapshot (subject to the current Recall Safe settings).

Store Stores the current state of the console in the targeted snapshot for all data types and channels, overwriting any existing data in the snapshot.

Propagate Enables Propagate mode. Lets you apply isolated changes to one or more snapshots at once (such as updating a channel EQ across all snapshots).

Edit Enables Edit mode. Lets you adjust parameters freely and apply those changes to one or more snapshots. Changes can be applied in Absolute or Relative fashion.

Undo Returns the console to its state before the last snapshot command.

New Creates a new snapshot that captures the current state of all data types and channels.

Duplicate Creates a copy of the selected snapshots.

Clear Clears the contents of the targeted snapshot, but retains any associated MTC information.

Delete Deletes the targeted snapshots.

Snapshot Scope Controls

The selection of data types and channels to be recalled is referred to as the *scope* of a snapshot. The scope of data to be recalled is also stored within each snapshot.

The Snapshot Data Type buttons and on-screen Channels determine (and display) which data types are recalled for which channels on the console.

The Recall Safe tab provides global control of automation safe status for parameters on individual channels.

Scope States

Scoped Red display indicates that the data type or channel is currently scoped and will be affected by snapshot recall.

Not Scoped Gray display indicates that the data type or channel is not currently scoped and will not be affected by snapshot recall.

Data Type Scope Buttons

The Snapshot Data Type buttons display scope status for the corresponding types of controls on the console. See Table 22 on page 201 for a complete list.



Data Type Scope buttons showing different scope states

Channel Scope Controls

Channels are included or excluded from snapshots by clicking them on-screen in the Snapshot Channel Faders display. The Snapshot faders display the scope status of each channel on the console, along with indication of the fader positions and mute states that will result by recalling the targeted snapshot.

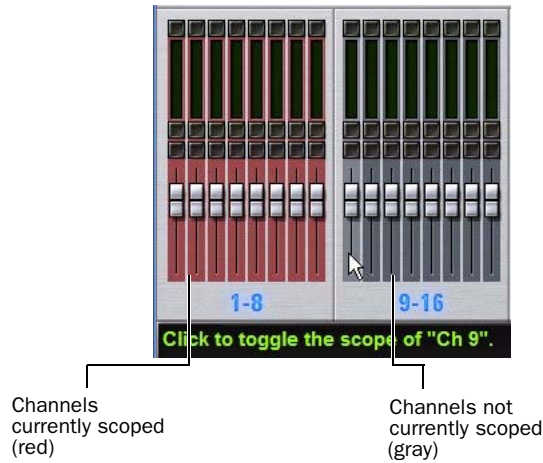

Snapshot channel fader display showing different scope states

Channel Fader Position

When you target a snapshot with scoped channels that have different fader positions from the current fader positions, the target fader positions are shown in bright red.



Snapshot channel fader display showing target fader positions

Channel Mute State

When you target a snapshot with scoped channels that have different mute states from the current mute states, the target mute buttons are outlined in yellow.



Snapshot channel fader display showing target mute states

Selected Channel Indication

The Snapshots page *indicates* the currently selected channel.

- ◆ If the selected channel is not scoped in the currently selected snapshot, it is indicated with a blue highlight.
- ◆ If the currently selected channel is scoped in the currently selected snapshot, it is indicated by a blue outline around the on-screen fader strip.

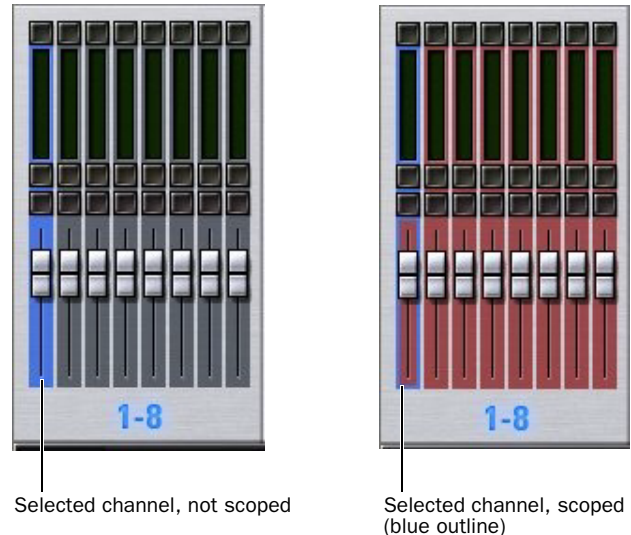

Selected channel indication in the Snapshots page

💡 *Though the currently selected channel is displayed in the Snapshots page, keep in mind that you cannot target a different channel from this page. The currently selected (target) channel is indicated for visual reference only. To select and target a different channel, use the channel Select switches or the Channel Scroll buttons.*

Data Type Scope Action Buttons

All Turns on the scope for all data types at once. This is equivalent to clicking all of the Data Type buttons so they are red.

None Turns off the scope for all data types at once. This is equivalent to clicking all of the Data Type buttons so they are gray.

Channel Scope Action Buttons

All Turns on the scope for all channels displayed on the current tab (such as 1–48). Double-clicking the All button turns on the scope for all channels on the system.

None Clicking the None button turns off the scope for all channels on the current tab. Double-clicking the None button turns off the scope for all channels on the system.

Next Snapshot Indication in Status Display

The Snapshot Status display shows the currently targeted (next) snapshot in red text directly above the display of the last (most recently recalled) snapshot. Pressing the Snapshot Recall button immediately recalls the targeted snapshot and makes it the last recalled snapshot.



Next and Last Recalled snapshot display in the Status area

Snapshot Controls on the Console

Snapshot controls are provided in three locations on the D-Show Main Unit: the Options & Snapshots section of the ACS, the Snapshot Master Controls, and the Snapshot Output Safe section.

Options & Snapshots Section

You can target (select), store, and recall snapshots from the Snapshots controls in this section.

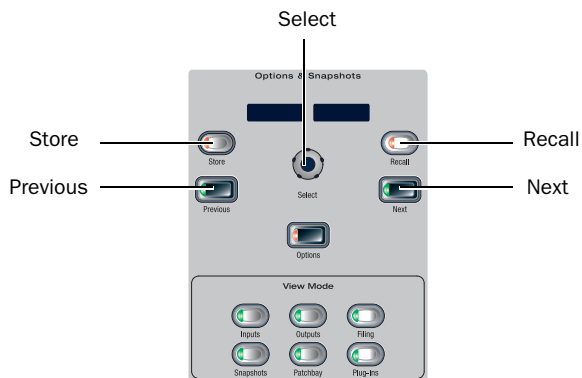

Snapshot controls in the ACS Section

The Snapshot controls in the Options and Snapshots section perform the following functions:

Store Stores the current state of all console parameters in the targeted snapshot. This switch mirrors the Store button in the Snapshots page.

Recall Recalls the targeted snapshot. This switch mirrors the Recall button in the Snapshots page.

Select Encoder and Displays Turning the Select encoder scrolls through and selects the targeted snapshot in the Snapshots list. The displays show the number and name of the currently targeted snapshot. A period is appended to the displayed snapshot name to indicate whenever it has been edited since being recalled.

Previous Instantly recalls the previous snapshot in the Snapshots list. This switch mirrors the Recall Previous button in the Snapshots page.

Next Instantly recalls the next snapshot in the Snapshots list. This switch mirrors the Recall Next button in the Snapshots page.

⚠ *The Previous and Next switches combine target and recall actions in one step, causing the next or previous snapshot to be instantly active. These switches cannot be used to preview snapshots before recalling them.*

Snapshot Master Controls



Snapshot Master Control switches

The following controls are available on the console in the Snapshot Master Controls section:

Safe Selected Lets you put any combination of Input channels and Output channels in automation safe mode. This switch works independently of the Safe switches on Input channels.

Safe All Toggles all Input channels and Output channels in and out of automation safe mode. This switch works independently of the Safe switches on Input channels.

Chase MTC Enables automated recall of snapshots when the MTC Read or MTC Generate options are enabled. This switch mirrors the Chase MTC button in the Snapshots page.

Disable Temporarily disables all snapshot functions. The Disable switch lights to indicate that the Disable function is active. This switch mirrors the Disable button in the Snapshots page.

Snapshot Output Safes

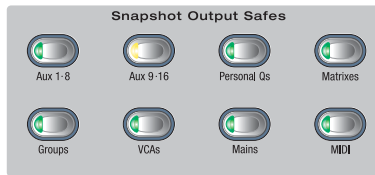

Snapshot Output Safe switches

Output Safe controls the automation safe status of all 8 output channels of a given type. Output Types include:

- Auxes (1–8 and 9–16)
- Personal Qs
- Matrixes
- Groups
- VCAs
- Mains
- MIDI

Individual output channels cannot be safed with these switches. Use Safe Selected to safe individual outputs.

You can also use Recall Safe to safe individual channels and specific parameters (see “Recall Safe and Channel Automation Safe” on page 185).

 *The MIDI Safe switch mirrors the function of the MIDI Snapshot Output Safe option. See “Safing MIDI Message Output” on page 196.*

F1 for Preview Mode

By default, pressing F1 engages Preview mode but you can change this setting in the Event List.

 *For more information on how to use the Event List, see Chapter 22, “Events.”*

Snapshots List



Snapshots list

Snapshot Entries

Each entry in the Snapshots List has a number (001–999) and name, along with icons for Lock and Enable status. If either the MIDI Read or Generate feature is enabled, each snapshot will also have a time code value, trigger indicator, or send indicator. Tempo can also be shown, instead of MIDI (both MIDI and Tempo are available parameters at all times; the only limitation is that the Snapshots List can only display one or the other at a time).

Recall Buttons

The Recall Previous (–) and Recall Next (+) buttons at the top of the Snapshots List cause the previous or next snapshot to be targeted and recalled in one step.

Chase MTC

Enables or suspends automated recall of snapshots when either the MTC Read or MTC Generate option is enabled.

Navigating the Snapshots List

Snapshots are highlighted in color in the Snapshots list to indicate the following:

Green Indicates the last recalled snapshot

Red Indicates the currently targeted snapshot

Yellow Indicates that the snapshot is both the last recalled and currently targeted snapshot

Blue Indicates that the snapshot is part of a multiple snapshot selection but not the last recalled or currently targeted snapshot. Recalled and Targeted snapshots can also be part of a multiple selection in the list. In this case, the sequence number is blue while the rest of the name is red, green or yellow.

Snapshot Keyboard Shortcuts

When the Snapshots page is displayed, you can perform the following Snapshot functions with these keyboard shortcuts:

Snapshot Function	Keyboard Shortcut
Target Next/Previous Snapshot	Up/Down Arrow keys
Target First Snapshot in List	Home key
Target Last Snapshot in List	End key
Target Snapshot at Top of Page	Page Up
Target Snapshot at Bottom of Page	Page Down
Select Multiple Contiguous Snapshots	Shift-click snapshots
Select Multiple Non-Contiguous Snapshots/Deselect any Snapshot	Ctrl-click snapshots
Select All Snapshots	Ctrl+A
Create New Snapshot	Ctrl+N
Recall Targeted Snapshot	Ctrl+R
Store Targeted Snapshot	Ctrl+S
Undo	Ctrl+U
Add or update MIDI/Plug-in data to snapshot	Right-click MIDI/Plug-ins entry

Selecting Snapshots

You can select single snapshots or multiple snapshots in order to target, recall, duplicate, edit, lock or delete them in the snapshots list.

To select multiple contiguous snapshots:

- Shift-click the snapshot names in the Snapshots list.

To clear a selection of multiple contiguous snapshots:

- Click any snapshot name in the Snapshots list.
 - or –
- Turn the Select knob in the Snapshots section.

To select or de-select non-contiguous snapshots:

- Ctrl-click the snapshot names in the Snapshots list.



Multiple items selected in the Snapshots list

Snapshot Type Text Search

Type Text search lets you use the keyboard for fast navigation of the Snapshots List.

To search for and target a snapshot:

- Go to the Snapshots page.
- Do one of the following:
 - Type the number of the snapshot.
 - or –
 - Type the first letters of the snapshot name.
- Press the Tab key to cycle through any snapshots that start with the same letter.

Centering the Snapshot List

The Options > Snapshots page provides a preference setting to always center the Snapshot list on the last recalled snapshot. This setting lets you always view the snapshots immediately above and below (prior to and following) the last recalled snapshot. This setting only affects the scroll position of items in the Snapshot list.



Snapshot list with Center Last Recalled Snapshot enabled

To center the Snapshot List on the last recalled snapshot:

- Go to the Options > Snapshots page.
- In the Snapshots General Preferences section, click to select the Center Last Recalled Snapshot setting.

Creating Snapshots

Snapshots can be created at any time to store the current channel and parameter settings. You can create new snapshots manually in the Snapshots page (see “Creating New Snapshots” on page 183), or by duplicating existing snapshots to build your mix as you work.

 Use the first snapshot in a Show file to establish the basic settings for a performance. For subsequent snapshots, use the scope controls and Recall Safe settings to selectively recall only those controls that need to change between sections or songs, leaving other controls unaffected by snapshot recall.

Creating New Snapshots

When you create a snapshot, it captures the current state of all console settings.

To create a new snapshot:

- 1 Set all parameters on the console whose state you want to store in the snapshot.
- 2 Click New. The new snapshot appears in the Snapshots List.
- 3 For each channel you want affected when the snapshot is later recalled, click the channel so that it is scoped (displayed in red).



Adding channels to the scope of a snapshot

 To quickly select (or de-select) banks of channels, click their blue labels below the Channel Faders in the Snapshots page.

- 4 For each parameter of the scoped channels you want affected when the snapshot is later recalled, click the corresponding Data Type button so that it is scoped (displayed in red).



Plug-ins included in the scope of a snapshot

 When you create a new snapshot it automatically inherits the channel and data type scope of the currently targeted snapshot.

 The New command can be undone.

Naming Snapshots

New snapshots are automatically numbered and appear as “<Untitled>” in the Snapshots list. Snapshots can be renamed at any time. You can undo snapshot naming operations.

To name a snapshot:

- 1 Do one of the following:
 - Double-click the snapshot name in the Snapshots list or the current target name display.
 - or –
 - Right-click the snapshot name and choose Rename.
- 2 Type a name for the snapshot.
- 3 Press Enter on the keyboard or click another snapshot name.

Adding Notes to Snapshots

You can add notes to snapshots at any time. You do not need to store the snapshot to save the notes in the snapshot.

To add or edit comments for a snapshot:

- 1 Double-click the Notes header or click the list icon to expand the Notes field.
- 2 Double-click in the Notes field and enter text.

Recalling Snapshots

Targeting Snapshots

Targeting a snapshot lets you preview which data types and channels will be affected by that snapshot before recalling it. When a snapshot is targeted, the on-screen Data Type buttons and Channel Faders update to show the data types and channels enabled for recall by the snapshot.

 *Preview mode lets you take the console offline to recall and edit snapshots in their entirety without affecting the current mix. See “Preview Mode” on page 192.*

To target a snapshot, do any of the following:

- Click the snapshot name in the Snapshot list.
- Type the number or name of the snapshot on the keyboard.
- Press the Home/End, Page Up/Page Down, and Up/Down Arrow keys to navigate the Snapshot list.
- Turn the Select knob in the ACS to scroll through the Snapshot list. Snapshot names appear in the display above the Select knob.

The current target snapshot is highlighted in red in the Snapshots list, and shown in red in the Status display.

Recalling Snapshots

You can do the following when recalling snapshots:

- Target and instantly recall successive snapshots (next or previous)
- Target first, then recall one or more snapshots
- Select multiple snapshots and recall them all sequentially
- Target snapshots, change Data Type or Channel Scope settings, then recall.

 *Undoing snapshot recall commands might cause audio to be interrupted. Use Undo with caution in performance.*

Recalling Successive Snapshots Instantly

You can instantly recall successive snapshots in the Snapshots list. This command references the previously recalled snapshot, not the last targeted snapshot.

To instantly recall successive snapshots, do one of the following:

- On the console, press the Previous or Next switch in the Snapshots section.
– or –
- On-screen, click the Recall Previous (–) or Recall Next (+) button at the top of the Snapshots list.

 *The Snapshot Recall buttons combine target and recall actions in one step, causing the previous or next snapshot to be instantly active. These buttons cannot be used to preview snapshots before recalling them.*

Targeting Before Recalling Snapshots

To target and then recall a snapshot:

- 1 Target the snapshot you want to recall by clicking the snapshot name in the Snapshot list, or turning the Select knob in the Snapshots section.
- 2 (Optional) Set the scope of the snapshot by doing the following:
 - For each channel you want to recall in the snapshot, click the channel so that it is scoped (displayed in red).
 - For each parameter of the scoped channels you want to recall in the snapshot, click the corresponding Data Type button so that it is scoped (displayed in red).
 - Configure the Recall Safe page to further filter snapshot data on recall. (See “Recall Safe and Channel Automation Safe” on page 185.)
- 3 Click the Recall button on-screen, or press the Recall switch in the Snapshots section.

 *Snapshot Recall can also be triggered by a footswitch or any number of other console functions in the Events window. For more information, see Chapter 22, “Events.”*

Selecting and Recalling Multiple Snapshots

You can select and recall multiple snapshots to load them all in sequence, and in one step. This is useful to quickly reset the console to a sub-cue or other specific point within a longer scene or cue and “pick up from there.”

To recall multiple snapshots:

- 1 Select multiple snapshots in the list (Shift-click to select multiple adjacent (contiguous) snapshots; Ctrl-click to select non-contiguous items or to deselect a single item).
- 2 Press the Recall switch, or click the Recall button on-screen.

 *If multiple snapshots are selected, toggling Data Type or Channel Scope buttons affects all selected snapshots. This provides a quick way of removing a channel or data type (such as EQ) from some or all snapshots. This action can be undone using the Undo button.*

Recall Safe and Channel Automation Safe

The Recall Safe tab in the Snapshots page provides global automation safe settings of nearly every section of the console.

You can also place individual channels in automation safe from the console or on-screen. For more information, see “Automation Safing Channels” on page 188.

Recall Safe

Recall Safe lets you select which parameters on which channels you want to be ‘safed’ from snapshots.

Recall Safe is global to all snapshots, can be turned on or off quickly, and provides preset capabilities in the form of Scope Sets. Scope Sets can be loaded and saved just like Presets for built-in EQ, Dynamics, and plug-in settings. Current Recall Safe settings are stored with the Show file.

Recall Safe Tab

The Recall Safe tab opens the Recall Safe page on-screen. The Recall Safe tab is red when Recall Safe is on and in effect, and gray when Recall Safe is off or when nothing is safed.



Indication of active Recall Safe from the main Snapshots page

Recall Safe Displays and Controls

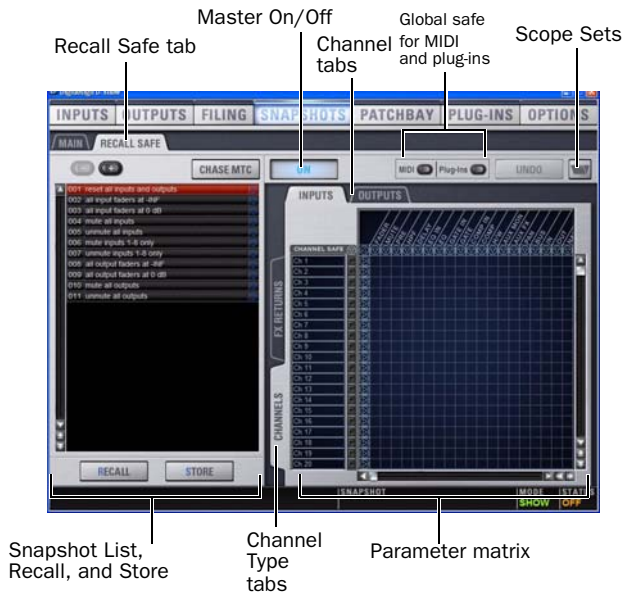

Displays and controls in the Recall Safe page

On

The master On button toggles the entire Recall Safe feature on or off globally. When lit (blue), Recall Safe is active. When dark, Recall Safe is suspended.

Snapshot List, Recall and Store

The Snapshot List and its Recall and Store functions remain visible and available from the Recall Safe page at all times.

Channel Tabs

The Inputs and Outputs tabs at the top of the parameter matrix selects the channel type whose safe status you want to view or edit. Along the left side of the parameter matrix are channel Type selector tabs, which will change depending on whether you are viewing Input or Output tabs.

 Shift-click channel type tabs to view more than one type at once in the scrollable parameter matrix.

Global Safe for MIDI Output and Plug-Ins

These checkboxes let you globally suspend recall of MIDI output and/or plug-in changes. They are considered separate from the parameter matrix and do not follow the Recall Safe master On (or Off) status.

Scope Sets

Scope Sets are presets for the Recall Safe page that can be stored and loaded, just like plug-in, EQ and Dynamics presets. Scope sets can be used as a template when creating new shows, or used to change Recall Safe settings during a performance. Like other presets and settings files, Scope Sets can be transferred from the Filing page, making it easy to maintain and transfer Recall Safe configurations. For more information, see “Using Scope Sets” on page 187.

Parameter Matrix

The parameter matrix is a scrollable grid in which you can save parameters and channels. You can undo and redo parameter matrix operations.

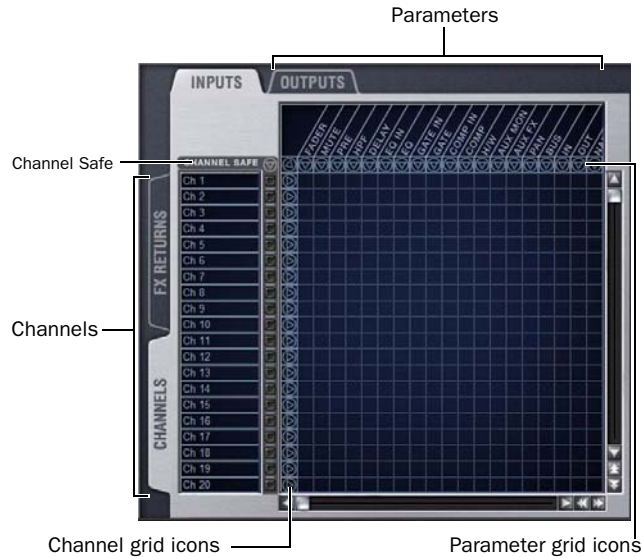

Parameter matrix for Recall Safe

Parameters are represented in the columns of the parameter matrix; channels are listed along the left side in rows.

Clicking in the grid enables safe status for that parameter on that channel. Parameter and Channel grid icons provide shortcuts to “safe all” parameters in a single-click, and to safe entire channels. Clicking these icons lets you quickly toggle recall safe status for entire columns and rows. You can also use the master grid icon located in the upper left most corner to toggle the entire grid.

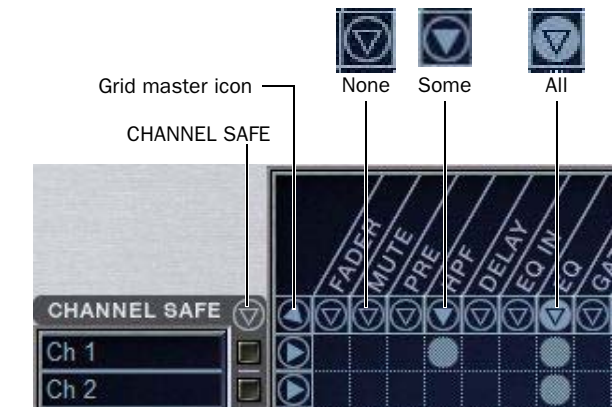

Display states for grid icons in Recall Safe

The display state of the Parameter and Channel grid icons indicate safe status for that column or row as follows:

None A dark Parameter or Channel grid icon indicates that no items in that column or row are safe enabled.

Some A dark triangle inside a lit blue circle indicates that at least one item in that column or row is safe enabled.

All A lit (white) triangle indicates that all items in that column or row are safe enabled.

Channel Safe Controls

The CHANNEL SAFE column acts as a global “all channel” setting or override, mirroring the SAFE switch on the console and on-screen (when in Input Safe Switches act as Automation Safes mode).

Controls in the CHANNEL SAFE column are not part of the parameter matrix; they function *in addition to* the parameter matrix. As a result, you do not need to enable any CHANNEL SAFE settings to use the Recall Safe parameter matrix.

For more information, see “Automation Safing Channels” on page 188.

Using Recall Safe

To access the Recall Safe page:

- Do one of the following:
 - Go to the Snapshots page and click the Recall Safe tab.
 - or –
 - Double-press the Snapshot View switch until the Recall Safe tab is displayed.
- Click a channel type tab to display the desired channels.

To safe individual parameters on specific channels:

- Click in the grid at the intersection of the appropriate parameter (column) and channel (row). A blue dot appears, indicating a parameter is safed.



Enabling recall safe for channel 1 fader

To safe multiple parameters or channels at a time:

- Click and drag in a column, across a row, or at an angle.

To safe individual parameters or channels:

1 Place the cursor above the grid, above a parameter or channel name, or above any Channel Safe button. To be sure the cursor is above a valid area, you should be able to see at least one parameter name or channel name highlight.

2 Use the Arrow keys of the computer keyboard to move the cursor right, left, up, or down to other grid points. (You cannot navigate to parameter or channel grid icons, or to the Channel Safe column.)

3 Press Enter to enable or disable safe status for the currently focused grid point. Continue navigating to and toggling safe status of other parameters and channels.

To safe a parameter across all currently displayed channel types:

- Click the Parameter grid icon at the top of the appropriate column until the triangle is white.

To safe all parameters for a particular channel:

- Click the Channel grid icon in the ALL column for that channel (row).

To toggle the status of a parameter column or channel row:

- Click the appropriate Parameter or Channel grid icon repeatedly until it displays the desired status. For more information, see “Parameter Matrix” on page 186.

To safe all parameters across all channels and clear any current settings:

- Click the triangular icon at the top of the ALL column.

 You can undo or redo the last action taken in the parameter matrix.

CHANNEL SAFE

To automation safe an individual channel and retain all recall safe settings for that channel:

- Click in the CHANNEL SAFE column for the desired channels.

 CHANNEL SAFE does not need to be lit in order to Recall Safe individual parameters for that channel.

To automation safe all parameters across all channels and retain all current recall safe settings:

- Click the CHANNEL SAFE master icon at the top of the Channel Safe column.

 The CHANNEL SAFE column mirrors the channel automation Safe controls. For more information, see “Automation Safing Channels” on page 188.

MIDI

To enable Recall Safe for MIDI Snapshot output:

- Click the MIDI Snapshot Output Safe button, located above the parameter matrix.

 For more information, see “Adding MIDI Messages to Snapshots” on page 195.

Plug-Ins

To enable Recall Safe for plug-ins:

- Click the Plug-In Snapshot Safe button, located above the parameter matrix.

 For more information, see “Adding Plug-In Data to Snapshots” on page 197.

Matrix and PQ

Snapshots can store and recall all source assignments of each Matrix and PQ mixer when the Matrix (Mtx) and/or PQ data types is scoped. In addition, all User Input assignments are stored, letting you reconfigure Matrix or PQ mixers and User Input assignments on a per snapshot basis, if desired.

The Recall Safe tab of the Snapshots page provides three parameters for Matrix and PQ snapshot recall safe:

MIX Safes both Source and User assignments.

MIX SRC Safes only source inputs.

MIX USER Safes only user input assignments.

For a list of what can be stored and recalled in each snapshot, see “Snapshot Data Types and Parameters” on page 201.

Using Scope Sets

Configurations of the Recall Safe page can be stored as Scope Set settings files. Scope Sets can be previewed, recalled and transferred just like plug-in, EQ and Dynamics settings.

To store the current Recall Safe settings as a Scope Set:

- 1 Configure the Recall Safe page as desired.
- 2 Click the Scope Sets icon (the folder icon located above and to the right of the parameter matrix).
- 3 Click New.

To preview and recall a saved Scope Set:

- 1 From the Recall Safe page, click the Scope Set icon to display the Scope Set window.
- 2 If necessary, choose the appropriate Scope Sets folder by clicking and selecting it from the Folder selector.

3 Do any of the following:

- To preview an existing Scope Set, click its name in the Scope Sets window.
- To load the currently selected Scope Set, press Enter or click the Close box (X) in the Scope Sets window title bar.
- To cancel without changing Recall Safe settings, click Cancel.



Scope Sets Folder selector

Scope Sets window

💡 See Chapter 20, “Shows and File Management” for complete information on transferring system data.

Automation Safing Channels

Input Safe switches (both console and on-screen) can be set to Automation, Solo, or Bank Safe modes. When set to act as Automation Safes, the Input Safe Switches let you suspend the effect of snapshots on all parameters of individual Input Channels and FX Returns.

💡 You can also control channel automation safe status in the Recall Safe tab. See “CHANNEL SAFE” on page 187.



On-screen Automation Safe button

To set the Input Safe Switches to Automation Safe mode:

- 1 Go to the Options page and click the Interaction tab.
- 2 In the Input Safe Switches section, select the Act as Automation Safes option.

To Automation Safe an input channel from the console:

- Press the Safe switch on the input channels or FX returns you want to safe. The Safe switch lights solid to indicate that the channel is automation safed.

💡 You can use the Event List to be able to cycle through the various Input Safe Switch modes using a footswitch, function switch or other available trigger. See Chapter 22, “Events.”

Managing Snapshots

You can manage snapshots in the list by storing, locking, clearing, duplicating, deleting, or moving them.

Storing Snapshots

You can modify the contents of an existing snapshot, overwriting it with new settings, using the *Store* command. It is not necessary to recall a snapshot to store it. Snapshots can be stored from on-screen or from the snapshot controls on the console. You can undo Store commands.

To store the current console state in an existing snapshot:

- 1 Set all parameters on the console as you want them to be stored in the snapshot.
- 2 Select the snapshot in the on-screen Snapshot list, or turn the Select knob in the Snapshots section to target a snapshot you want to overwrite.
- 3 Click the Store button on-screen, or press the Store switch in the Snapshots section.
- 4 Set the scope by doing the following:
 - For each parameter you want to be affected when the snapshot is recalled, click the corresponding Data Type button so that it is scoped (displayed in red).
 - For each channel you want affected when the snapshot is recalled, click the channel fader so that it is scoped (displayed in red).

Locking Snapshots

Snapshots can be *locked* to prevent them from being accidentally altered, overwritten or deleted.

Locked snapshots can be selected, recalled, moved and duplicated. They cannot be overwritten, renamed, rescoped or otherwise changed. New and duplicated snapshots default to unlocked. Lock status can be changed at any time, including while in Preview mode.

To lock a snapshot:

- 1 Go to the Main tab of the Snapshots page.
- 2 In the Snapshot list, click the padlock icon at the far right of the row for any item. The padlock icon illuminates to indicate the snapshot is now locked.

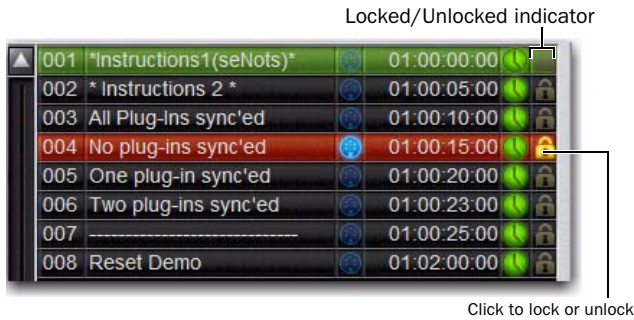

Snapshot lock controls

Select multiple snapshots using the Shift key or Multi-Select switch to lock or unlock multiple snapshots at once.

Once locked, operations that would otherwise affect the snapshot cause the Status display and channel LCDs and Snapshot LCD to temporarily show a message reminding you that the operation cannot be applied while the snapshot is locked.

To unlock a snapshot:

- Click the lit padlock icon in the row for that snapshot.

You can undo locking or unlocking of a snapshot by clicking the Undo button.

Undo and Locked Snapshots

You can undo locking or unlocking a snapshot. When toggling lock status for a selection of more than one snapshot, the entire operation creates a single undo point (it does not track and provide undo for each individual snapshot in the selection).

⚠ *Keep in mind that Undo can revert snapshots to “unlocked” status. For example, if you change the scope of an unlocked snapshot, lock the snapshot and then use Undo, the snapshot is unlocked. Pressing Undo one more time will revert the snapshot to its original scope.*

Locking Snapshots and MIDI Record

When using the MIDI Record feature, all MIDI data captured up to the point a snapshot is locked is preserved. If the MIDI Record operation is still active at the time the snapshot is locked, record mode is exited, the REC button becomes unavailable for that snapshot, and subsequent incoming MIDI messages are not captured.

Available Operations with Locked Snapshots

The following table details which operations can or can not be performed on a locked snapshot.

Summary of allowed/disallowed operations when locked

Operation	Allowed while Locked	Disallowed while locked
Select/target snapshot	X	
Recall snapshot	X	
Duplicate snapshot	X	
Re-sequence in snapshot list by:		
• Dragging in snapshot list	X	
• Manually editing sequence number	X	
• Re-sorting by time code	X	
Overwrite (Store to locked snapshot)		X
Propagate changes		X
Apply Edit mode changes		X
Clear		X
Delete		X
Modify Scope		X
Add/Modify stored MIDI data		X
Add/Modify stored Plug-In data		X
Modify Notes		X
Modify X-Fade time		X
Modify Snapshot Name		X
Modify Time Code Location		X
Toggle Time Code Enable		X
Undo changes	X	

Clearing Snapshots

The contents of a snapshot can be cleared while keeping the snapshot in the Snapshot list and retaining its MTC information. This lets you maintain a placeholder that you can use later to store new data. You can undo Clear commands.

To clear the contents of a snapshot:

- 1 Select the snapshots you want to clear.
- 2 Click Clear. Cleared snapshots are renamed “<Empty>.”

Duplicating Snapshots

Snapshots can be duplicated from the Snapshots list. You can undo Duplicate commands.

To duplicate snapshots:

- 1 Select the snapshots you want to duplicate.
- 2 Do one of the following:
 - Click Dup (Duplicate).
 - or –
 - Right-click the snapshot name and choose Duplicate.

A copy of each selected snapshot is placed after the selection, with a plus sign (+) appended to the original snapshot name.

If multiple snapshots are selected in the list, the new (duplicate) items are added below their original source snapshots.

Deleting Snapshots

Snapshots can be deleted from the Snapshots list. You can undo Delete commands.

To delete snapshots:

- 1 Select the snapshots you want to delete.
- 2 Do one of the following:
 - Click Del (Delete).
 - or –
 - Right-click the snapshot name and choose Delete.

The snapshots are removed from the Snapshots list, and succeeding snapshots are renumbered.

Moving Snapshots

Existing snapshots can be rearranged in the Snapshots list. When you move one or more snapshots, they are automatically renumbered in the list, but MTC values are left unchanged. You can undo a snapshot move.

To move a snapshot, do one of the following:

- Drag the currently selected snapshots to a new location in the Snapshots list.
- or –
- Double-click the snapshot number in the Snapshots list or the banner display, type a new number, and press Enter on the keyboard.

Making Changes to Snapshots

There may be situations where you need to change specific parameters in existing snapshots while leaving other parameters unchanged.

For example, if a guitarist changes instruments in the middle of a tour it might be necessary to change levels and EQ on the guitar channel in all the snapshots in a show. Snapshots provides the following modes to accommodate these types of situations:

Edit Mode Lets you capture individual control changes while you mix, and apply those changes to one or more pre-existing snapshots as absolute or relative changes. For example, you could enter Edit mode the first time a guitarist uses a new guitar in rehearsal. When you are satisfied with your settings you can apply them (in absolute or relative fashion) to update other snapshots. See “Using Edit Mode” on page 190.

Propagate Mode Lets you update data in pre-existing snapshots after you've already made changes and decided you want to keep them. While Edit mode requires you to know ahead of time that you will be updating snapshots, Propagate mode lets you decide to update other snapshots with current settings after making adjustments to your mix. For example, if its the third consecutive night you've reached to increase gain on the DI channel for a new guitar, you could use Propagate mode to quickly take the gain increase you just made and apply it to other snapshots. See “Using Propagate Mode” on page 191.



Events-driven recall of snapshots is disabled while in Propagate or Edit mode. For more information, see Chapter 22, “Events.”

Using Edit Mode

Edit mode is a powerful way to update specific parameters across multiple snapshots without overwriting any settings you want to preserve. By entering Edit mode before making adjustments, you can edit a single control or any number of controls, and your changes are tracked from the point Edit mode was entered.



The ability to edit a single control in Edit mode provides more selectivity than Propagate mode.

Absolute and Relative Edits

Changes can be applied to one or more selected snapshots as *absolute* or *relative* values. Any parameter can be edited in absolute fashion; all dB parameters can be edited in relative fashion.

Examples of Absolute and Relative Edits

Absolute Changing a fader level from 0 dB to -3 dB and applying that change as Absolute results in that fader being set identically to -3 dB in all selected snapshots.

Relative Changing a fader level from 0 to -3 dB and applying that change as Relative results in that fader being reduced by that amount in all selected snapshots, or 3 dB relative to the value previously stored in the snapshot(s). For example, a channel previously at -6 dB would be changed to -9 dB.

Making Relative Changes with Mixed Data Types

If a combination of dB and non-dB parameters (such as gain and EQ frequency) are edited and applied in relative fashion, the dB parameters are adjusted as relative (delta) changes and the non-dB are applied as absolute changes.

To update specific parameters in existing snapshots using Edit mode:

- 1 Navigate to the main Snapshots page.
- 2 Click the Edit button to enter Edit mode. The Edit button changes into two smaller flashing buttons: Abs, and Rel. The system begins tracking all changes while you make them.



Edit mode

- 3 Adjust any combination of snapshottable parameters on the console or on-screen.
- 4 Select the snapshot(s) to which you want to apply your edits.
- 5 Click either of the flashing buttons Abs (for Absolute) or Rel (for Relative). You can cancel Edit mode by pressing the Cancel button on the control surface, clicking the Cancel button on-screen, or by pressing the ESC key on your computer keyboard.

The selected snapshots are updated according to your changes and your choice of Absolute or Relative edit.

Using Propagate Mode

You can use the Propagate command to capture changes and apply them to existing snapshots. Propagate mode is most useful when you realize during the course of mixing that you want to capture your current settings to use in other snapshots. You can undo Propagate commands.

To update specific parameters in existing snapshots:

- 1 Make sure the channel is set as needed.
- 2 Click Propagate. The current data and channel scope is cleared.
- 3 Set the scope to reflect only those parameters you want to update by doing the following:
 - For each parameter you want to update, click the corresponding Data Type button so that it is scoped (displayed in red).
 - and –
 - For each channel you want to update, press its channel Select switch on the console, or click the channel on-screen so that it is scoped (displayed in red).



Propagating an EQ change for a channel

- 4 Select the snapshot or range of snapshots you want to update in the Snapshots list.
- 5 Click Propagate. The scoped parameters are updated in the selected snapshots.

Preview Mode

Preview mode lets you recall, store and edit snapshots without affecting the current mix.

When enabled, Preview mode takes the console offline from the live audio mix so you can “work ahead” during a rehearsal, performance or event to preview upcoming snapshots and edit them as needed. Any control that can be stored and recalled by snapshots is available while in Preview mode, and you can also modify the Snapshot List. Once you are done previewing or editing snapshots, you can store your changes to update the existing snapshots with your changes.

Using Preview Mode

The basic workflow for using Preview mode is as follows:

- 1 Make sure your active mix is set as desired, and make sure the rehearsal, event or performance has an upcoming opportunity for you to go offline.
- 2 Enter Preview mode by clicking the on-screen Preview button in the main Snapshots page. The word PREVIEW flashes in red across the screen for confirmation. (By default, the Function switch F1 is assigned to Preview mode, but this can be customized using Events. For more information, see Chapter 22, “Events.”)



Preview mode

- 3 Do any of the following:

Edit the Snapshots List Reorder snapshots in the list, if desired, by clicking and dragging them. Changes to the order of items in the Snapshots list may affect the current active mix if the affected snapshots rely on MIDI or MTC triggering. (For more information, see “Changing Console Settings in Preview Mode” on page 193.)

Create a New Snapshot Adjust settings as desired and create a new snapshot by clicking New. (See “Creating New Snapshots” on page 183.)

Recall and Edit an Existing Snapshot Recall a snapshot to preview its settings and make any adjustments necessary, being sure to re-store the snapshot before exiting Preview mode. Storing a snapshot in Preview mode does not affect previously stored MIDI or Plug-in data (if any).

Edit Channel and Scope Settings Edit any channel settings, parameters, or scope associated with the snapshot being previewed. The Snapshots page displays the current snapshot name in italics to indicate that at least one parameter has been changed, and the Channel Faders show you the previous level for each channel in bright red. Scope Data Type buttons and Channel Scope functionality remain live and active at all times (in other words, changes made to these controls while in Preview mode will remain once Preview mode is exited).

Add and Edit MIDI or Plug-In Data To add MIDI or plug-in data associated with the snapshot, click the Add button in the MIDI or Plug-Ins snapshot list. With plug-ins this adds the current online plug-in settings to the snapshot. If you need to update pre-existing MIDI or plug-in data associated with a snapshot, right-click the corresponding entry in the MIDI/Plug-ins view of the Snapshots page and choose the Update option (this option will include the plug-in rack position, and the name of the associated snapshot). For more information, see “Plug-Ins and MIDI in Preview Mode” on page 194.



Updating snapshot plug-in data

- 4 To undo an action made while in Preview mode, click the Undo button on-screen. (For more information about Undo in Preview mode, see “Making Changes to Snapshots” on page 190.)
- 5 To update the currently previewed snapshot but remain in Preview mode, press or click Store.
- 6 Continue previewing and editing settings as needed (all snapshot functions are available in preview mode).
- 7 When you are finished and need to exit Preview mode, press F1 (or click the on-screen Preview button).

⚠ *Exiting Preview mode without storing will discard the changes made while in Preview mode (Preview mode is cleared each time you exit). You must explicitly store changes to update the associated snapshots.*

Undo and Preview Mode

In Preview mode, you can Undo actions applied to the Snapshot List (such as Recall, Store, New and Duplicate) without affecting the online mix.

 *Multiple levels of Undo are available.*

Changing Console Settings in Preview Mode

The system tracks any changes to console settings or to the Snapshot List while in Preview mode, but only Snapshot List actions create an Undo point. Choosing Undo will undo the last action you took while in Preview mode, up to a maximum of 100 levels of Undo. Any changes to console settings made after the last Preview action are also undone (the Snapshot screen is returned to its exact state prior to the action that created the Undo point).

Changing the Snapshot List in Preview Mode

Changes made to the Snapshot List are automatically tracked and available for Undo, regardless of whether Preview mode is enabled or not. This includes any Recall of snapshots triggered by incoming MIDI or MTC while in Preview mode.

For example, if a MIDI Snapshot Recall occurs while you are in Preview mode, the online mix will be updated with that snapshot. Pressing Undo immediately after that Recall will undo that Snapshot recall and revert the online mix to its state prior to the Undo.

Consider turning off the Chase MTC option while in Preview mode to disable all MIDI recall of snapshots. In addition, you can always use the History feature to recover from any unexpected results.

Changing MIDI or Plug-In Data in Preview Mode

Changes made to MIDI and Plug-In data cannot be undone. For more information, see “Adding MIDI Messages to Snapshots” on page 195 and “Adding Plug-In Data to Snapshots” on page 197.

 *Take advantage of Tool Tips in the banner display to confirm what action the Undo button will revert. See “Undoing Snapshot Commands” on page 195.*

Available and Unavailable Functions in Preview Mode

In order to maintain essential mix indicators and controls while in Preview mode, not all functions are taken offline.

The following sections detail what is and what is not available during Preview mode.

Always Active

Certain essential mix functions remain live and active at all times, regardless of whether Preview mode is enabled. The following vital mix functions continue to affect or be affected by the console and software:

- Metering (including input, output and dynamics meters, clip and bank clip indicators)
- AFL/PFL
- Dynamics Key Listen
- Monitoring level, Headphone level and Monitoring bus Delay
- Talkback, Osc and 2-Track
- Mute Groups (recall only)
- Recall Safe
- MIDI snapshot Recall, Chase MTC and Disable (Snapshots)
- Snapshot List and Recall Safe (deleting, adding, or editing snapshots are/will be reflected online and affect the mix)
- History (auto-save)

Recall Safe in Preview Mode

The Recall Safe settings are global, and are applied to filter snapshot data regardless of the current operating mode. For details on Recall Safe and other automation safe features, see “Recall Safe and Channel Automation Safe” on page 185.

Available and Editable in Preview Mode

Almost all system functions, such as selecting channels and banking faders, are available in Preview mode.

 *Only those controls that can be stored and recalled via snapshots are available for offline previewing and editing.*

Not Available in Preview Mode

The only controls not available while in Preview mode are those controls which are not able to be stored or recalled via snapshots. In addition, Config mode options are unavailable in Preview mode.

Unavailable functions include the following:

- Make Stereo, or Split to Mono
- Move channels
- Input channel Gain Guess
- Input channel and FX Return Input Direct switch
- Input channel Dyn Pre EQ switch
- Insert mode (plug-ins cannot be edited)
- Enabling or disabling sample rate conversion

 *These functions are neither available for offline access in Preview mode, nor do they remain active (online) while in Preview mode. To adjust any of the above settings, you must exit Preview mode.*

Config Mode

Config mode is not available while in Preview mode. Pressing the Config switch (or double-clicking the Config/Show mode icon on-screen) displays a dialog box in which you can choose to “Exit Preview” (return to online mix, in Config mode), or “OK” (remain in Preview mode).

The system automatically switches to Show mode if Config mode is active at the time Preview mode is entered.

Plug-Ins and MIDI in Preview Mode

In Preview mode, plug-ins and MIDI operate in a similar way as when using the standalone software.

Plug-Ins in Preview Mode

Recalling a snapshot that contains plug-in data affects the offline (Preview) routing and bypass state of the plug-in only; the online plug-in parameter settings are not recalled, and the online mix is not affected.

The following plug-in functions are available offline in Preview mode:

- Plug-in routing can be changed
- Plug-in rack view can be changed
- Plug-ins can be added to a snapshot to capture its current online parameter settings and (Preview mode) routing

The following plug-in functions are not available while in Preview mode:

- Plug-ins cannot be added to or removed from rack slots
- Plug-in presets cannot be recalled or saved
- Plug-in parameters cannot be changed (you cannot open plug-in windows while in Preview mode)
- Plug-ins cannot be installed

You must explicitly add or update plug-in (or MIDI) data to update snapshots, whether or not Preview mode is enabled. You can do this from the main Snapshot page, or from the plug-in racks.



Updating plug-in data in an associated snapshot from the plug-in view

MIDI in Preview Mode

Incoming MIDI or MTC continues to trigger snapshot recall while in Preview mode. However, MIDI messages stored to snapshots are not sent out when a snapshot is recalled in Preview mode. For more information, see “Adding MIDI Messages to Snapshots” on page 195 and “Adding Plug-In Data to Snapshots” on page 197.

MTC and Other Online Event Triggers

While in Preview mode, triggers that occur in the online state of the console are executed, including MTC-driven recall of snapshots. Triggers caused by changes to the offline (Preview) controls are ignored and do not cause events to occur. For more information, see Chapter 22, “Events.”

Undoing Snapshot Commands

The Undo function returns the console to the state immediately before the last snapshot command. Undo is multi-level (up to 100), is available while in Preview mode and after performing an Edit or Propagate mode action.

⚠ *Undoing snapshot recall commands may cause audio to be interrupted. Use Undo with caution in performance.*

- ◆ If the Undo button is highlighted, you can place the cursor over the button to display text in the status bar describing what snapshot actions will be undone.
- ◆ If the Undo button is dimmed, Undo is not available.

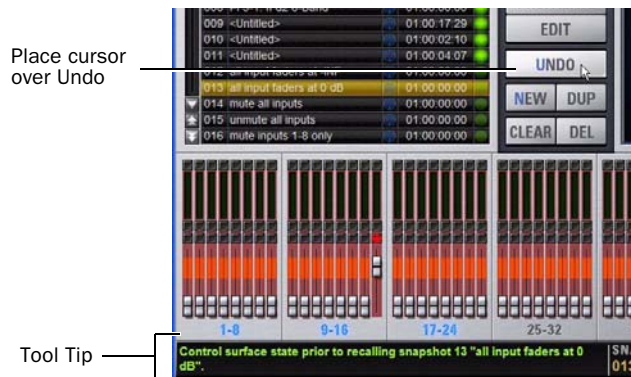

Using Tool Tips to verify the effect of Undo in the Snapshots page

To undo a snapshot command:

- Click the Undo button in the Snapshot commands section.

Disabling Snapshots

You can temporarily disable the storage and recall of all snapshots. While snapshots are globally disabled, you can target snapshots in the Snapshots List to preview their properties, but you cannot recall them.

To disable all snapshots:

- Click the Disable button in the Snapshot commands section.

Suspend MTC Recall

To disable MTC Recall of individual snapshots in the list:

- 1 Click the green Enable icon in the row for the desired snapshot so that it is unlit.
- 2 Click the Disable/Enable icon again to re-enable the snapshot.

You can similarly suspend Tempo on a per snapshot basis (see "Adding Tempo Data to Snapshots" on page 196).

Adding MIDI Messages to Snapshots

No MIDI message data is captured when a snapshot is first created. MIDI messages are added to existing snapshots directly from the MIDI list. You can store up to 20 MIDI messages in each snapshot.

When the MIDI data type is scoped for a snapshot, any stored MIDI messages are sent when the snapshot is recalled.

The following MIDI messages are supported and available in the MIDI list:

- Note Off
- Note On
- Poly Key Pressure
- Control Change
- Program Change
- Channel Pressure
- Pitch Bend
- MIDI Machine Control Stop
- MIDI Machine Control Play
- MIDI Machine Control Fast Forward
- MIDI Machine Control Rewind
- MIDI Machine Control Eject
- MIDI Machine Control Chase
- MIDI Machine Control Pause
- MIDI Machine Control Locate

When the MIDI data type is scoped for a snapshot, its MIDI messages are sent when the snapshot is recalled.



Snapshots List showing snapshot containing MIDI messages

To add a MIDI message to a snapshot:

- 1 Target the snapshot you want to modify.
- 2 Double-click the word MIDI in the MIDI/Plug-Ins list header to expand the MIDI list.
- 3 Click Add and choose a message from the pop-up menu.



Adding a message to the Snapshot MIDI list

A MIDI plug icon appears in the Snapshots List for each snapshot that contains MIDI messages.

To record incoming MIDI data to a snapshot.

- 1 Click REC.
- 2 Send a supported MIDI command.
- 3 Click REC again when done.

To edit a MIDI message in the MIDI list:

- 1 Double-click the message text to display the pop-up menu bar for the message.

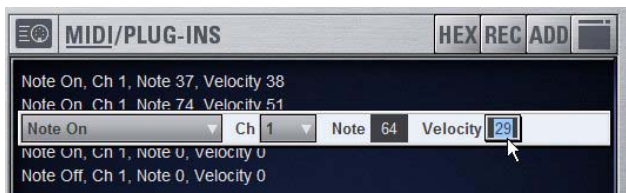

Editing a MIDI message in the snapshot MIDI list

- 2 Choose the message name and send channel or device ID from the pop-up menus.
- 3 Enter the message values in the text fields or drag up or down across the text field to change the values.
- 4 Click in the MIDI list area to dismiss the pop-up menu bar.

To remove a MIDI message from a snapshot:

- Right-click the MIDI message in the MIDI list and choose Delete.

Viewing MIDI Messages in Hexadecimal Format

You can toggle the view of MIDI messages in the MIDI list between hexadecimal and decimal formats.

To toggle the view format of the MIDI list:

- Click the Hex button in the MIDI/Plug-Ins list header.

Safing MIDI Message Output

You can temporarily disable output of embedded MIDI messages so that they are not sent when a snapshot is recalled, even when the MIDI data type is scoped.



MIDI output is automatically suspended while in Preview mode.

To safe MIDI message output on-screen:

- 1 Go to the Snapshots page and click the Recall Safe tab.
- 2 Click the MIDI global output Safe button above the parameter matrix so that it is lit.

Adding Tempo Data to Snapshots

The Snapshots List can be toggled to display Tempo, along with a Tempo On/Off indicator for each snapshot entry.

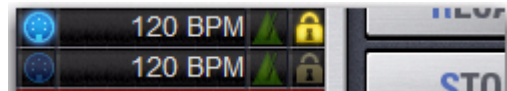

Snapshots List showing tempo

Storing a tempo with snapshots lets your system tempo change per song or scene. This lets you take full advantage of Tempo Sync (aka Tap Tempo) to synchronize delay and echo plug-ins.

Displaying Tempo in the Snapshots List

To show Tempo in the Snapshots List:

- Right-click anywhere in the Snapshots List and choose Show Tempo.

Tempo is displayed in BPM (beats per minute) or milliseconds, as set in the Options > Misc page.

To change the units for Tempo display:

- 1 Go to the Options > Misc page.
- 2 In the Tap Tempo section, click to select BPM or ms.

To sort items by tempo:

- With Tempo shown in the Snapshots List, right-click and choose Sort by Tempo.

Assigning and Enabling a Tempo

Each snapshot can store a custom tempo value. You can manually enter a custom tempo, or use a shortcut to assign the current System Tempo.

You can use the Tempo Enable icon to enable or disable tempo recall when the associated snapshot is recalled.

To assign a Tempo value to a snapshot manually:

1 In the Snapshots List, double-click the Tempo value you want to change, then do one of the following:

- From the keyboard, type a new tempo value.
- or –
- Press the Up and Down Arrow keys to increase and decrease the selected value.

2 Press Enter or click another snapshot Tempo value to confirm the entry.

To assign the current System Tempo to a snapshot:

- 1 Make sure Tempo is shown in the Snapshots List.
- 2 Right-click and choose the Set Tempo to option, which will display the current System Tempo.

The System Tempo is set in the Options > Misc page. For details on configuring the system tempo and using it to synchronize plug-ins, see “Tap Tempo for Plug-ins” on page 214.

To toggle tempo on/off for each snapshot:

- 1 Make sure Tempo is shown in the Snapshots List (if not, right-click any item in the list and choose Show Tempo).
- 2 Click the Tempo icon so that it is lit (enabled) or unlit (disabled).

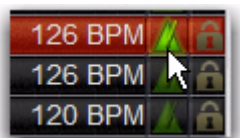

Snapshots List showing tempo

For more information on enabling Events for Tap Tempo, see “Tap Tempo for Plug-ins” on page 214.

Adding Plug-In Data to Snapshots

No Plug-In data is captured when a snapshot is first created. Plug-In data is added to existing snapshots from the Plug-Ins list or from the Plug-In rack.

When the Plug-In data type is scoped for a snapshot, plug-in routing, in/out state, and settings are recalled with the snapshot. (Adding or changing plug-in side-chain routing is not supported in snapshots.)

The Snapshots Plug-Ins list lets you select multiple plug-ins and add, remove and update them simultaneously across one or multiple snapshots. Multiple snapshots can be selected, and others can be added to or removed from the selection, at any time prior to adding, removing, or updating plug-ins and snapshots.

Plug-Ins List

To view plug-in data for snapshots in the MIDI/Plug-Ins list:

- 1 Target the snapshot you want to modify, or select multiple snapshots in the list.
- 2 Double-click Plug-Ins in the MIDI/Plug-Ins list header to expand the Plug-In list.

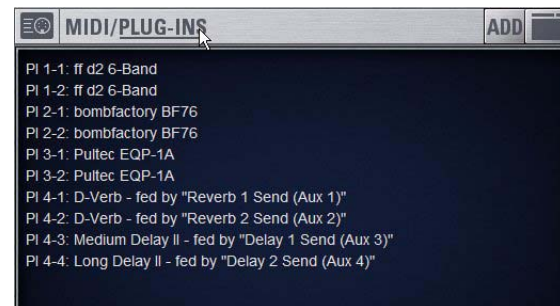

Expanded Plug-In list

It is also possible to select multiple plug-ins in the Snapshots Plug-Ins list and remove or update these plug-ins across multiple snapshots using Right-click commands. Selections can be contiguous or non-contiguous plug-ins in the list. This lets you more easily manage all plug-ins inserted on a single channel, for example.



Managing multiple plug-ins across multiple snapshots

Adding Plug-Ins to Snapshots

To add a plug-in to one or more snapshots from the Snapshots page:

- 1 Select an individual snapshot, or create a multi-selection of snapshots in the Snapshots list.
- 2 Display the Plug-Ins List (see “Plug-Ins List” on page 197).
- 3 Click the ADD button within the Snapshot Plug-Ins list and select a plug-in (or All Plug-Ins) from the menu.

To add a plug-in to multiple snapshots from the Plug-Ins page:

- 1 Create a multi-selection of snapshots on the Snapshots page
- 2 Go to the Plug-Ins page.
- 3 Click the Snapshots menu for the plug-in to be added and choose Add This Plug-In To Selected Snapshots. The selected plug-in is added to the currently targeted snapshot, as well as all other snapshots within the multi-selection.

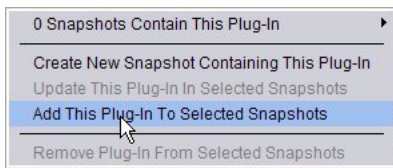

Using the Snapshots pop-up menu in the plug-in rack (Plug-Ins page)

Snapshots within the multi-selection that already contained the plug-in being added are unaffected and preserve any previously stored settings.

Removing a Plug-In from Snapshots

To remove a plug-in from snapshots from the Snapshots page:

- 1 Select an individual snapshot, or create a multi-selection of snapshots in the Snapshots List.
- 2 Click the Snapshots Plug-Ins icon to show the Snapshots Plug-Ins list.
- 3 Right-click a plug-in within the plug-in list of the currently targeted snapshot and choose Remove This Plug-In From Selected Snapshots.

To remove a plug-in from multiple snapshots from the Plug-Ins page:

- 1 Create a multi-selection of snapshots on the Snapshots page
- 2 Go to the Plug-Ins page.
- 3 Click the Snapshot menu for the plug-in to be removed and choose Remove This Plug-In From Selected Snapshots.

The selected plug-in is removed from the currently targeted snapshot, as well as all other snapshots within the multi-selection. Only snapshots within the multi-selection that contain the selected plug-in are affected.

Updating a Plug-In Across Multiple Snapshots

To update a plug-in across snapshots from the Snapshots page:

- 1 Select an individual snapshot, or create a multi-selection of snapshots on the Snapshots page.
- 2 Select a plug-in within the plug-in list of the currently targeted snapshot.
- 3 Right-click and choose Update Plug-In In Selected Snapshots.



Snapshots plug-ins pop-up menu with multiple plug-ins selected in the Snapshots page

To update a plug-in across multiple snapshots from the Plug-Ins page:

- 1 Create a multi-selection of snapshots on the Snapshots page
- 2 Go to the Plug-Ins page. All plug-ins that are associated with any of the currently selected snapshots are identifiable by their red Snapshot menu.
- 3 Click the Snapshots menu for the plug-in to be updated and choose Update This Plug-In In Selected Snapshots.

The selected plug-in is updated within the currently targeted snapshot, as well as all other snapshots within the multi-selection. Snapshots within the multi-selection that do not already contain the plug-in being added are unaffected.

Editing Plug-Ins

The Snapshot page provides two ways to quickly navigate to a plug-in in order to edit its routing assignment or parameters.

To edit a plug-in associated with a snapshot:

- Double-click the item in the Snapshot Plug-Ins list. Or, right-click a plug-in in the Snapshots Plug-Ins list and choose Edit Plug-In.

Snapshot Options

The Options > Snapshots page provides Snapshot General Preference settings for centering the snapshot list, and for optimizing crossfades between snapshots.

The next section explains how to utilize snapshot crossfade. (For information on the Center Last Recalled Snapshot preference, see “Centering the Snapshot List” on page 182.)

Snapshot Crossfades

All snapshots provide a Crossfade setting that determines how long scoped faders will crossfade to the stored values in that snapshot when it is recalled. The Options > Snapshots page provides Snapshot General Preference settings for optimizing crossfades between snapshots.



Snapshot preferences in the Options > Snapshots screen

Default Time Defines a Crossfade time to apply to all new snapshots.

Pan, Balance & Width Enables pan, balance and width on scoped channels to crossfade.

Faders can be crossfaded on all channel types. Pan, balance, and width can crossfade on input channels, FX Returns, Groups, and PQ outputs. In order to crossfade, the desired channels must be scoped, as well as Fader and Pan data types.

To configure snapshot crossfade:

- 1 Go to the Options page and click the Snapshots tab.
- 2 In the Snapshot General Preferences section, enter a non-zero value for Default Crossfade Time. Maximum crossfade time is 99.9 seconds.
- 3 To enable pan parameters to follow the snapshot crossfade time, click to enable the Pan, Balance & Width setting. (See “Pan, Balance and Width Crossfade Reference” on page 200.)
- 4 Go to the Snapshots page and make sure to do both of the following:
 - Scope the desired channels by clicking to select them in the fader display.
 - Click to scope Fader to crossfade channel fader levels; click to scope Fader and Pan to crossfade fader and pan. (For a listing of parameters by data type, see “Pan, Balance and Width Crossfade Reference” on page 200.)

Special Cases for Crossfade Bypass

Incoming MIDI Commands

The snapshot crossfade is not bypassed if a MIDI Program Change message recalling the same snapshot is received during the crossfade.

MTC

The snapshot crossfade is not bypassed if a MTC trigger recalling the same snapshot occurs during the crossfade.

Multiple Simultaneous Crossfades

The crossfade can be bypassed for the most recently recalled snapshot only.

Preview Mode

If you enter Preview mode in between Recall commands, the offline (Preview mode) crossfade will be bypassed; the online crossfade will not.

Pan, Balance and Width Crossfade Reference

This table shows availability of pan, balance and width crossfade, by channel type.

Pan, Balance and Width Crossfade Parameter Reference

			Pan	Balance	Width
Inputs†	Input Channel	Mono	x		
		Stereo		x	x
	FX Return	Stereo		x	x
Output Masters††	Aux	Mono/Stereo-linked			
	PQ			x	
	Matrix	Mono/Stereo-linked			
	Groups	Mono	x		
		Stereo			x
	Variable Groups	Mono/Stereo-linked	x		

† Crossfade does not apply to Pan for channel Aux sends.

†† Crossfade does not apply to Pan for input sources within the Matrix or PQ mixer.

Pre Settings

Snapshots can be used to recall the preamplifier settings on inputs for all scoped Input Channels. You can set any of the following Pre parameters to be recalled by the Pre data type button: Gain, Pad and Phase/polarity, +48V (Phantom Power), HPF corner frequency and in/out state.

To set the Pre parameters recalled by the Pre Data Type button:

- 1 Go to the Options page and click the Snapshot tab.
- 2 Under Pre, select the options you want to include. Selected items will be affected when the Pre data type is included in the scope of a snapshot.



Setting Pre parameters

Classifying Aux Sends

You can classify Aux Sends as *monitor sends* (“Mon”) or as *effects sends* (“FX”), which lets you scope each type separately from the Snapshots page.

 This option is only a means of organizing Aux Sends for snapshot control, and does not directly affect Aux bus operation.

To classify Aux Sends for snapshot scope:

- 1 Go to the Options page and click the Snapshots tab.
- 2 For each Aux Send bus or bus pair, click the Aux Mon or Aux FX buttons to classify it as a monitor send or effects send, respectively.



Classifying Aux Sends

Aux Pre/Post State

Select this option to include the pickoff point pre-fader or post-fader state of each Aux Send in snapshots.

Snapshot Data Types and Parameters

Table 22. Snapshot data types and parameters included in each data type

Snapshot Data Type	Included Parameters (for Each Scoped Channel Strip)
Fader	Main volume level
Mute	Mute state
EQ	EQ type selection (analog/digital); EQ in-circuit state; 4 bands (2 bands on FX Returns) of gain, freq, Q, bell/shelf selection (digital only), band on/off
Dyn	Compressor/Limiter in-circuit state; threshold, ratio, attack, release, knee, makeup gain Expander/Gate in-circuit state; threshold, ratio, attack, release, hold time, range, side-chain input
Pan	Channel pan or balance/width (For details, see “Pan, Balance and Width Crossfade Reference” on page 200.)
Bus	Group bus assignments, group bus mono/stereo-linked state (if mono groups) or dual-mono/true stereo state (if stereo groups), L–R bus assignment and C/M bus assignments for input strips and groups
In	Input routing for Input Channels and FX Returns
Out	Main out assignments; direct out assignments, level, in-circuit state, & tap-off point (excluding VCAs)
H/W	Hardware insert routing and in-circuit state (excluding VCAs)
VCA	VCA membership
Pre	Gain, pad, phase, phantom power, HPF corner frequency & in-circuit state
Name	Name for each strip
MTX	Mixer Input Sources, User Input Assignments, and pickoffs; Mixer Input level, Mixer Input on/off and Mixer Input Link state
PQ	Mixer Input Sources, User Input Assignment, and pickoffs; Mixer Input level, pan, and on/off state, Mixer input Link state, Llimiter threshold and Llimiter in/out
Aux Mon	On/off, pre/post selection, level, and pan/balance for each Aux bus classified as a Monitor Aux
Aux FX	On/off, pre/post selection, level, and pan/balance for each Aux bus classified as an FX Aux
Dly	Channel delay time & in-circuit
MIDI	All MIDI messages that were added to the associated MIDI list for that snapshot.
Plug-Ins	Rack slot settings, in-circuit state, and I/O routing for each plug-in added to plug-ins list for that snapshot

Chapter 22: Events

This chapter introduces the Events window, and explains how to use the Event List.

Introduction

An *event* consists of one or more *triggers*, which are configured to cause one or more *actions* to occur.

Events can be very simple, such as a Footswitch input triggering a Recall Next Snapshot command. This is an example of a single *trigger* (a footswitch input) causing a single *action* (Recall Next Snapshot).

Events can also be quite complex and involve multiple triggers and actions. For example, a single event can be defined so that moving a specific fader above and/or below a certain level sends a General Purpose output, recalls a specific snapshot *and* mutes one or more channels. Multiple triggers can be considered conditionally using the available logic operators AND, OR, and XOR.

The Event List is easy to configure, and many preconfigured events are provided for Tap Tempo, snapshot Preview mode and other functions.

 *For more information on the default events and other examples, see “Default Settings, Templates and Examples” on page 213.*

Terminology

Event A user-defined combination of one or more triggers and one or more actions. Each event serves as a type of software “macro” in which you establish a cause-and-effect relationship between one or more console functions (triggers) and their results (actions).

Trigger A conditional check used to fire an event.

Action A console function, mode or other response resulting from an event being triggered.

GPI General Purpose Interface, also commonly known as a logic interface. (Not available on D-Show systems.)

Open GPI input or GPI output is floating, or at its reference voltage.

Closed GPI input or GPI output is closed.

Footswitch Footswitch ports are functionally identical to GPI inputs and share all of the same properties and behaviors.

Important Information about Snapshots and Events

Because Events can trigger snapshot recalls, and because snapshot recalls can trigger other events, it is possible to create logic “feedback loops.” For more information, see “Avoid Feedback Loops” on page 212.

The Events Window

The Events window is the working area of the Event List system, and is available in the Options page (Options > Events).

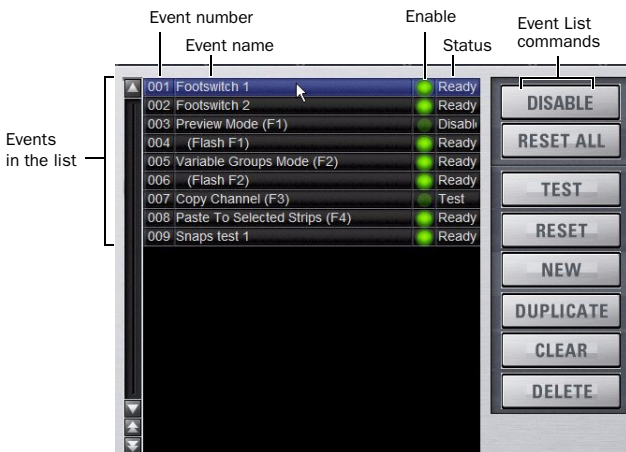

Figure 14. Events window (Options > Events)

Events are defined and managed from the upper Event List area of the Events window. This area includes the scrollable Event List at the left, plus the Triggers and Actions sections to its right. The lists and commands available in these sections create a powerful, user-programmable environment.

Events

An *event* consists of one or more *triggers*, which in turn cause one or more *actions* to occur. Up to 999 events can be created. Each event can have between 0 and 8 triggers, and each event can have between 0 and 8 actions.



Event List items, commands and displays

Event List Each event is shown in its own row within the Event List. The list can be scrolled vertically when necessary.

Event Number Each event has an associated three digit sequence number, 001 through 999. Events are automatically re-numbered if items are moved, added or removed.

Event Name Events can be given custom names, up to a maximum length of 31 characters.

Event Enable Icon Events can be enabled or disabled individually by clicking the green Enable indicator to toggle its status. All events can be disabled (suspended) and enabled using the global Disable button.

Event Status The Event Status column shows Active (currently in effect), Ready, Disabled or Test state. For more information on the Status column, see "Resetting Events" on page 211.

Event List Commands You can test, reset, create, duplicate, clear or delete events in the list. These commands can be performed using the on-screen buttons or by right-clicking on list items. Multiple events can be selected to test, reset, duplicate, clear or delete them, but only one new event can be created at one time.

Triggers

The Triggers list shows the name and properties of each trigger defined for the currently selected event, as well as commands to create and manage triggers.



Triggers list items, commands and displays

Triggers List

Each event can have up to eight triggers in the list. Triggers are shown in rows in the Triggers list. Right-click commands let you select, edit, duplicate and delete triggers.

Add

The Add pop-up menu lets you create new triggers. Triggers are organized in the menu according to the type of console function or input signal that initiates (or triggers) the event. Types of triggers include channel functions, footswitch/GPI inputs, snapshot recall, and other console functions such as talkback.

Type and Properties

Each row in the Triggers list shows the selected trigger Type. Some types of triggers have editable properties such as a dB level on a specific channel, or open/closed state of a footswitch input. Choices vary depending on the trigger type, and not all triggers have editable properties.

Logical Operators

Multiple triggers can be considered conditionally by applying a logical operator (AND, OR, XOR) to their properties.



Triggers and actions which are unavailable due to unavailable hardware or console configuration are shown as italicized in the Trigger (and Action) Add menus.

Actions

The Actions list shows the actions defined in the currently selected event, as well as commands to create and manage actions.

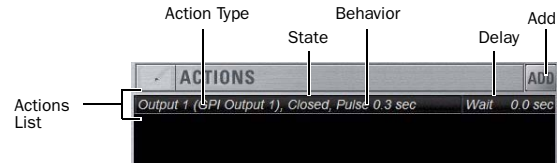

Actions list items, commands and displays

Actions List

Each event can have up to eight actions in the Actions list. All actions occur when the event is fired. Right-click commands let you select, edit, duplicate and delete actions.

Add

The Add pop-up menu lets you create new actions. Actions are organized in the menu according to the type of function they affect, such as channel functions, snapshots, GPI Output and Tap Tempo.

Type and Properties

Each row in the Actions list shows the selected action Type. Some actions have editable State and Behavior settings: all actions have a Wait (Delay) setting.

Footswitch and GPI Status

The Status display across the bottom of the Event window includes the Footswitch and GPI sections, which show the present open or closed status of each logic port. Each port can be named. (GPI is not available on VENUE D-Show systems.)

Creating Events

The basic steps to create an event include the following:

- Add a new event in the Event List (see “Adding an Event” on page 206).
- Add and configure triggers for the event (see “Adding Triggers to an Event” on page 208).
- Add and configure actions for the event (see “Adding Actions to an Event” on page 210).

 Several pre-defined (default) events are available immediately; others are available among the Demo Shows installed with the system software. For more information, see “Default Events” on page 213.

Adding an Event

To add a new Event to the Event List:

- 1 Go to the Options > Events page.
 - 2 Do any of the following:
 - To create an empty, untitled new event, click the New button in the Event Commands section.
- or –
- To create a copy of a pre-existing event, select one or more events in the list and click the Duplicate button.

Selecting Events

Event list items can be selected, renamed, duplicated, deleted, cleared, enabled or disabled, tested and reset.

To select one or more events, do any of the following:

- To select a single event, click its row in the Event List.
- To select all events, right-click an event and choose Select All.
- To select multiple contiguous events, click the first desired event and then Shift-click (or Multi-Select-click) the last desired event. All events in between are selected.
- To select multiple discontinuous events, or to de-select an individual event, Ctrl-click (or Fine-click) its row in the Event List.



Events selected in the Event List

To deselect or ore more events:

- Right-click anywhere in the Event List and choose Deselect All.

Moving Events

Selected events can be dragged and dropped to new locations in the list. You can also manually edit the Event number to re-sequence items.

To move one or more events:

- 1 Select one or more events in the Event List.
- 2 Click in the row of any selected event and drag to a new location in the list. As you move events, a white line appears indicating the destination.
- 3 Release the mouse button to drop the events at the desired location in the Event List. When moving multiple events, moved events will be adjacent regardless of their original locations relative to each other (whether adjacent or non-adjacent). Events will be renumbered as necessary according to the new sequence of events.

To manually edit an Event number:

- Double-click the Event Number and enter a new three digit number to resequence the list accordingly.

Managing Events in the Event List

Once created, events in the list can be managed using on-screen buttons and right-click commands to rename, duplicate, delete, clear, enable or disable them.

 You can also use the Test and Reset commands to manually audition events for development and diagnostics. For more information, see “Testing Events” on page 211

Renaming an Event

To rename an event:

- 1 Double-click the Event Name in the list. Or right-click the Event Name and choose Rename.
- 2 Enter a new name.
- 3 Click Enter to confirm the new name.

Duplicating an Event

Duplicating an event can simplify Event List configuration when multiple, similar events need to be created, each with slightly different properties.

To duplicate an event:

- 1 Select one or more events in the Event List.
- 2 Click the Duplicate button on-screen. Or, right-click a selected event and choose Duplicate.

Deleting and Clearing an Event

Deleting an event removes it permanently from the Event List. *Clearing* an event leaves the named Event in the Event List but clears all associated triggers and actions.

To delete an event:

- 1 Select one or more events in the Event List.
- 2 Do one of the following:
 - Click the Delete button on-screen.
 - Right-click a selected event and choose Delete.
- 3 Click Delete in the Confirm Event Operation dialog to delete the event. Or click Cancel to cancel the operation.

To clear an event:

- 1 Select one or more events in the Event List.
- 2 Do one of the following:
 - Click the Clear button on-screen.
 - Right-click a selected event and choose Clear.
- 3 Click Clear in the Confirm Event Operation dialog to clear the event. Or click Cancel to cancel the operation.

Enabling and Disabling Events

Events can be disabled to suspend their operation. An event can be selected and edited while it is disabled.

You can toggle the enabled state of one or more events in the list by clicking the on-screen Enable icons in the Event List, or you can disable the Event List globally by clicking the master events Disable button.

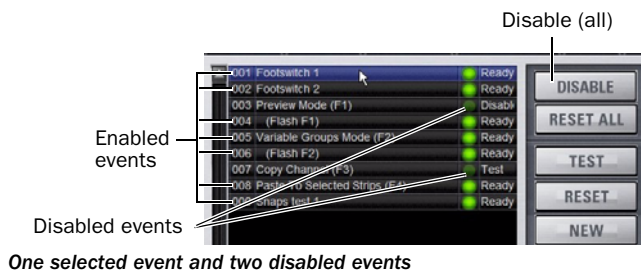

Toggle Enable Status for Selected Events

To toggle the enable/disable status of an event in the list:

- 1 Select one or more events in the Event List.
- 2 Click the Enable icon for the selected event to toggle its state. Or, right-click an item and choose Enable or Disable as appropriate. When the Enable icon is lit (green) the event is enabled; when the icon is unlit the event is disabled.

Disabling an active event does not automatically de-activate any associated actions configured for While Active behavior. Use the Reset command instead (see “Resetting Events” on page 211).

Disabling an event stops all delay timers (Wait properties) associated with that event, preventing any pending (delayed) actions from occurring.

 *Disabling an event can be a useful troubleshooting tool, such as when an event has caused an action/trigger feedback loop and must be edited before being re-enabled.*

Disable All Events

The Disable button in the Events Commands section lets you temporarily disable all events in the event list.

To disable all Events:

- Click the on-screen Disable button in the Events Commands area. The Disable button lights, and all items in the Event List show “Disabled” in the Status column.

To re-enable Events:

- Click the Disable button again.

All Events are prevented from firing when the global Disable function is in effect. However, active events are not de-activated. Use Reset or Reset All for this (see “Resetting Events” on page 211).

Individual Event enable/disable status is preserved (events retain the current state of their Enable icons) and can be modified when globally disabling and enabling events using the master Disable button.

Disabling an event stops all timers (Wait/delay properties) associated with that event, preventing any pending (delayed) actions configured for While Active behavior from occurring.

Creating Triggers

Each event can have up to eight triggers. You create new triggers by selecting them from the Add pop-up menu. Once added, you can edit triggers and their properties to customize them.

Adding Triggers to an Event

To add a trigger:

- 1 Select an event in the Event List, or create a new one. (For details, see “Selecting Events” on page 206, and “Creating Events” on page 206.)
- 2 Click the ADD pop-up menu in the Trigger list and select an action type. The selected trigger type is added to the Trigger list for the currently selected event, with its default properties.

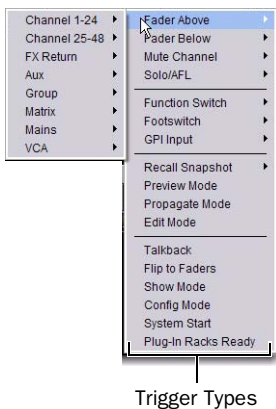

Add Triggers

 For a list of available trigger types, see “Trigger Types” on page 216.

Editing Trigger Type and Properties

To edit the trigger and its properties:

- 1 Double-click the trigger row in the list. Or right-click the action item and choose Edit.
- 2 Choose a new Trigger Type, or edit any of the available properties in the row for that trigger. Properties vary depending on the type of trigger selected (not all trigger types have editable properties).

Logical Operators for Triggers

An individual trigger is considered to be “true” when the function described by its type and properties takes place, such as while a footswitch is actually pressed, or a fader is raised above its trigger threshold.

A trigger is considered to be “false” (or, not occurring) whenever its function and properties are not met, such as when a footswitch is not being pressed, or while a fader remains below its assigned trigger threshold.

When an event includes multiple triggers, a logical operator (OR, AND, XOR) must be chosen from the Operators pop-up menu. (The default Operator is OR.)

The logical operator has no effect when the Triggers list includes only one item.

To choose a logical operator for the current event:

- 1 Select the desired event to display its assigned triggers.
- 2 Click the Operators pop-up menu (by default, this pop-up menu displays “OR”) and choose AND, OR, or XOR.

Only one logical operator is permitted per event, and this operator applies to all triggers within the event. It is not possible to use a mix of logical operators within an event.

Examples of Logical Operators

Logical operators determine the precise state required in order for an event to occur as shown in the following tables:

OR At least one of the triggers must be true. The following table shows the effect of OR on events with multiple triggers. In the table, 0 indicates a false condition (not occurring) and 1 indicates a true condition (occurring).

Example truth table for OR, showing two triggers

Trigger A	Operator	Trigger B	Result
0	OR	0	0
0	OR	1	1
1	OR	0	1
1	OR	1	1

When using OR, if one or more (but not all) of the triggers go false, the event logic is only acted on again when all triggers evaluate to false (result = 0).

AND All triggers must be true. The following table shows the effect of AND on events with multiple triggers. In the table, 0 indicates a false condition (not occurring) and 1 indicates a true condition (occurring).

Example Truth table for AND showing two triggers

Trigger A	Operator	Trigger B	Result
0	AND	0	0
0	AND	1	0
1	AND	0	0
1	AND	1	1

XOR

At least one trigger, but not all, must be true. The following table shows the effect of XOR on events with multiple triggers. In the table, 0 indicates a false trigger condition (not occurring) and 1 indicates a true condition (occurring).

Example Truth table for XOR showing two triggers

Trigger A	Operator	Trigger B	Result
0	XOR	0	0
0	XOR	1	1
1	XOR	0	1
1	XOR	1	0

Managing Triggers in the Triggers List

Triggers in the list can be edited, duplicated and deleted.

Editing Triggers

To edit a trigger:

1 Double-click the trigger in the Triggers List. Or, right-click the item in the list and choose Edit.

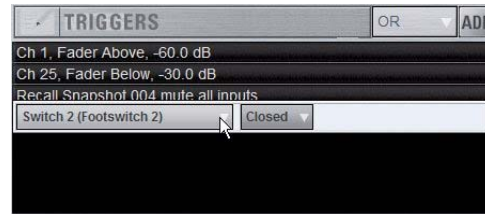

Editing a trigger

2 Do any of the following:

- To change the trigger type, click the Type pop-up menu and make a new selection from the Type menu.
- For Fader Above or Fader Below triggers, click the currently displayed dB value to highlight it, then type in a new value.
- For switches, buttons and other two-state functions, click the State pop-up menu and make a selection. Choices for State vary as appropriate for the trigger type, and will include Closed or Open, On or Off, and Pressed or Released.

3 To confirm your changes, press Enter or click anywhere else in the Events window.

Selecting Triggers

Triggers can be selected using the same methods as used when selecting items in the Event List. For more information, see “Selecting Events” on page 206.

Duplicating Triggers

To duplicate a trigger:

- 1 Select one or more items in the Triggers List.
- 2 Right-click on any selected item and choose Duplicate.

Deleting Triggers

To delete a trigger:

- 1 Select one or more items in the Triggers List.
- 2 Right-click on any selected item and choose Delete.

Creating Actions

Each event can have up to eight actions. You create new actions by selecting them from the Add pop-up menu. Once added, you can customize actions by editing their properties, as available.

Adding Actions to an Event

To add an action:

- 1 Select an event, or create a new one.
- 2 Click the ADD pop-up menu in the Action list and select an action type. The selected action type, with its default settings, is added to the action list area.

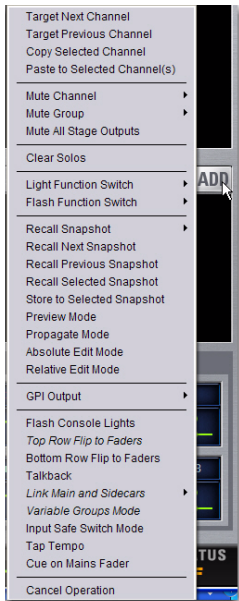

Add Actions

 For a list of available actions, see “Action Types” on page 217.

Editing an Action Type and Properties

To edit an action:

- 1 Double-click the action row in the list. Or, right-click the action item and choose Edit.
- 2 Click the displayed action Type and make a new selection.



Editing an action

Action State

To edit an action State for switches, buttons and other two-state functions:

- Click the State pop-up menu and make a selection. Choices for State vary as appropriate for the trigger type, and will include Closed or Open, On or Off, and Toggle.

Action Behavior

To edit action behavior:

- Click the Behavior pop-up menu and choose Latch or While Active, as appropriate:

Latch Fixes the behavior in its defined state (such as open or closed) until unlatched by another event or operation.

While Active Latches the behavior in its defined state as long the associated trigger is in effect (active, or “true”), such as unmuting a channel only while a footswitch is pressed and held.

Pulse and Duration (GPI Output only) Produces a single-shot pulse output. Duration range is 0.1 second (100 ms) to 1.0 second, in 0.1 second increments. The default duration is 0.3 seconds (300 ms).

GPI is not available on VENUE D-Show.

To configure GPI output pulse and duration for an action:

- 1 Double-click the action to edit it
- 2 Click the Behavior selector and choose Pulse.
- 3 Enter a value for Pulse Duration.
- 4 To confirm you changes, press Enter or click anywhere else in the Events window.

Action Wait

All actions let you specify a Wait time of up to 100 seconds for the action to wait before firing. This can be useful for synchronizing the timing of multiple external devices, or to build timed sequences of actions.

To configure action Wait (Delay):

- 1 Double-click the action to edit it.
- 2 To confirm your changes, click the Wait value to highlight it, then type in a new value.

Selecting Actions

Actions can be selected using the same methods as used when selecting items in the Event List. For more information, see “Selecting Events” on page 206.

Managing Actions in the List

Actions can be moved, renamed, duplicated, and deleted by right-clicking them and choosing the desired operation, just as you can with triggers. For instructions on managing items in the Actions List, follow the instructions for triggers in “Managing Triggers in the Triggers List” on page 209.

Testing Events

An event can be manually triggered to test it, regardless of its current Event Status or enabled/disabled state. Use this feature to verify action properties and confirm proper operation of devices connected to GPI output ports.

When an event is in Test mode, it is effectively considered true until the event is manually reset. An Event in test can be re-tested at any time by again pressing the Test button. You do not have to reset in-Test events to re-test them.

Incoming triggers are ignored when events are in Test mode. For example, if a footswitch event is being tested and you accidentally hit the footswitch at some point during the test, the event does not revert to Active the moment Test is cancelled.

Events always return to their ready state following a Reset. Events won't re-fire until the trigger logic re-asserts itself as true.

To test events:

- 1 Select one or more events in the Event List.
- 2 Click the Test button. Or, right-click an event and choose Test from the pop-up menu.
- 3 When you're satisfied the event is behaving correctly, click the Reset button. Or, Right-click an event and choose Reset.

Resetting Events

You can use the Reset features to quickly reset Active or in-Test events to “ready.” You can also use the Reset All command (in the Events Commands buttons) to immediately reset all events in the list.

The current status of each event is shown in the Status column in the Event List:

Event List Status indicators

Status	Description
Active	Event is currently true (triggered)
Ready	Event is currently false (not triggered)
Disabled	Event is disabled and can not be triggered
Test	Event has been manually triggered

To reset an event:

- 1 Select one or more events in the Event List. (See “Selecting Events” on page 206.)
- 2 Click the Reset button. Or, right-click an event and choose Reset to reset an Active or in-Test event back to a Ready state.

To reset all events:

- Click the Reset All button.

When events are reset, the following rules are applied:

- ◆ Latching or pulsed actions which have already occurred are unaffected. For example, reset doesn't unlatch a previously latched function.
- ◆ All action delay timers (Wait) are immediately cancelled.
- ◆ Actions configured for While Active behavior are immediately cancelled.
- ◆ Events will not occur until the trigger logic again evaluates as true.

For example, let's say you have an event configured to close a GPI Output whenever Channel 3 is muted (its behavior property is While Active). Resetting the event opens the GPI Output, even though the Channel 3 might still be muted. The event will re-trigger the next time the channel goes from an unmuted state to a muted state.

Snapshots and Events

Events can include snapshot functions among their triggers and actions.

Snapshots as Triggers

Events can be triggered by the following snapshot functions:

- Recall of specific snapshots
- Enabling of Snapshot modes (Preview, Propagate and Edit)

Snapshots as Actions

Event actions can include the following snapshot functions:

- Recall of a specific snapshot
- Recall the previous, next or selected snapshot.
- Initiate Store to Selected Snapshot commands (overwriting and updating snapshots)
- Enable different Snapshot modes (Preview, Propagate and Edit)

Snapshot Modes and Event Status

While in Propagate or Edit modes, events-driven snapshot recall is suspended.

While in Preview mode, triggers that occur in the online state of the console are executed, including MTC-driven recall of snapshots. Triggers caused by changes to the offline (Preview) controls are ignored and do not cause events to occur.

Avoid Feedback Loops

Because events can both affect and be affected by snapshots, it is possible for events to cause “feedback loops.”

Be especially careful when Recall Previous or Next snapshot triggers and actions are combined with events that recall a specific snapshot, as shown in the following diagram.

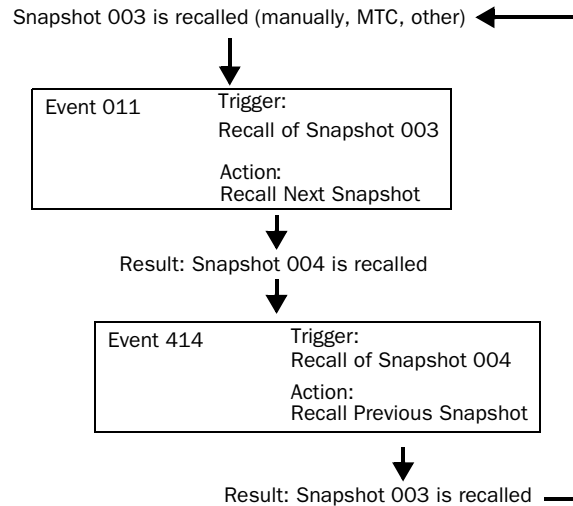

Diagram illustrating potential logic feedback loop between events and snapshots



The global Event Disable and Reset All buttons can serve as “panic” buttons to temporarily suspend and/or reset all events, giving you a chance to diagnose the source of the problem. For more information, see “Resetting Events” on page 211.

Default Settings, Templates and Examples

Default Events

The following pre-defined events are included for you to use as examples and as the starting point for your own events.

Default events

Event Number	Type and Name	Triggers	Actions
001	Footswitch 1	Switch 1 (Footswitch 1) Closed	<i>undefined</i> (choose an action)
002	Footswitch 2	Switch 2 (Footswitch 2) Closed	<i>undefined</i> (choose an action)
003	Preview Mode (F1)	Function Switch 1, Pressed	Preview mode, Toggle, Latch
004	(Flash F1)	Preview Mode, On	Flash Function Switch 1, On, While Active
006	(Flash F2)	Variable Groups Mode, On	Flash Function Switch 2, On, While Active
007	Copy Channel (F3)	Function Switch 3, Pressed	Copy Selected Channel Light Function Switch 3, On, While Active
008	Paste to Selected Strip (F4)	Function Switch 4, Pressed	Paste to Selected Channel(s) Light Function Switch 4, On, While Active
009	Tap Tempo	Function Switch 8, Pressed	Tap to define system tempo for delay plug-ins that support Tempo Sync

Templates

The following table provides a listing of common event definitions. Use the techniques explained throughout this chapter to add one or more of the following events to establish your own set of events, triggers and actions.

Suggested event definitions for common functions

Event Name	Trigger Type	Trigger Properties		Action Type	Action Properties		Behavior
Talkback (Toggle)	Footswitch 1		Closed	Talkback		Toggle	Latch
Talkback (Momentary)	Footswitch 1		Closed	Talkback		On	While Active
Fader Start	Fader Above	Ch 1	-60 dB	GPI Output 1		Closed	Pulse (0.3 s)
Fader Stop	Fader Below	Ch 1	-inf dB	GPI Output 1		Closed	Pulse (0.3 s)
Fader Start/Stop	Fader Above	Ch 1	-60 dB	GPI Output 1		Closed	While Active
Mute Channel (Toggle)	Footswitch 1	1	Closed	Mute	Ch 1	Toggle	
Mute Channel (Momentary)	Footswitch 1	1	Closed	Mute	Ch 1	On	While Active
Toggle Input Safe Switch mode	Function Switch 1		Pressed	Input Safe Switch Mode			
Tap Tempo	Function Switch 1		Pressed	Tap Tempo			
Cue on Mains	Function Switch 1		Pressed	Cue on Mains			

Using the Templates

To add any of the Events listed in the table, do the following (using the first template, Talkback (Toggle) as an example):

To use the templates:

- 1 Create a new event.
- 2 Edit the event name (for example, “Talkback (Toggle)” as shown in the table). For renaming instructions, see “Renaming an Event” on page 206.
- 3 Click the (Trigger) Add pop-up menu and choose Footswitch > Switch 1 (Footswitch 1). The Switch 1 trigger type is added, with a default State setting of Closed.
- 4 Click the (Action) Add pop-up menu and choose Talkback. The Talkback action is added. By default, the action State is Toggle, and the behavior is Latched. There is no Wait (delay before firing) needed for this action.

Switch 1 (Footswitch 1) is now configured to toggle Talkback On or Off each time the footswitch is pressed.

If you prefer momentary talkback, edit the event by doing the following.

- 1 Double-click the Talkback action in the Actions list to access its editable properties. Or, right-click the action and choose Edit.

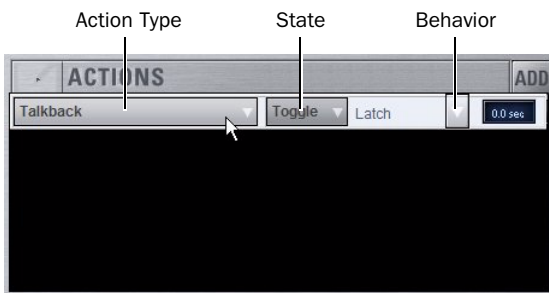

An action and its properties ready to be edited.

- 2 Click the action State pop-up menu (it displays Toggle by default, or the current State setting) and select On.
- 3 Click the action Behavior pop-up menu and select While Active. Together with the State setting (On), While Active establishes momentary control of the action; in this example, Footswitch 1 is now assigned to provide momentary Talkback control.

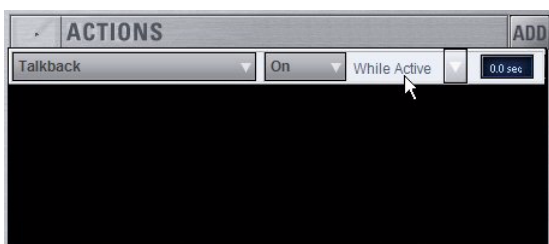

Talkback State and Behavior after editing

- 4 To quickly test the switch trigger, click the Test button, or press the Footswitch. Adjust the trigger State for your footswitch, as necessary, for its open/closed orientation. (For instructions, see “Editing Trigger Type and Properties” on page 208.)

- 5 After testing the trigger, click Reset to return the event to its Ready state.

Tap Tempo for Plug-ins

Tap Tempo lets you quickly establish a system tempo to use as a beat clock for delay and echo plug-ins that support Tempo Sync.

The system tempo defaults to 120 BPM (beats per minute). You can set a custom tempo in a number of ways including by tapping a Function switch, Footswitch or other control as explained below. The system tempo is stored as a console setting within the Show file.

Snapshots can also store and recall tempo.

 A preconfigured Event for tap tempo is installed in the Demo Shows folder when you install VENUE D-Show software. To use the example Event, go to the Filing page and click the Load tab, then select the file Tap Tempo Examples and click the Load button.

Using Tap Tempo

Do the following three steps to start using Tap Tempo:

Enable the System Tempo

- 1 Go to the Options > Misc page, locate the Tap Tempo section and do the following:
 - Turn on the global tempo sync by clicking the On switch directly below the encoder so that it is lit (on).
 - If desired, use the encoder to set a system tempo value, or type a value directly into the Tempo field.
 - If desired, click the Units selector to choose Beats Per Minute (BPM) or Milliseconds as the units for displayed values.

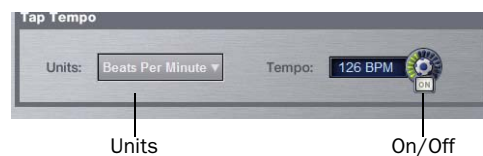

Tap Tempo settings

Create a Tap Tempo Event

2 Go to the Options > Events page and do the following in the order presented:

- Create a new Event and call it Tap Tempo.
- Click the Add button in the Trigger area, and select an available Function switch (F switch) or Footswitch.
- Click the Add button in the Action section, and choose Tap Tempo.

Enable the Plug-in's Tempo Sync and Start Tapping

Next, navigate to a delay plug-in and enable its Tempo Sync switch. Repeat for other delay plug-ins you want to sync.

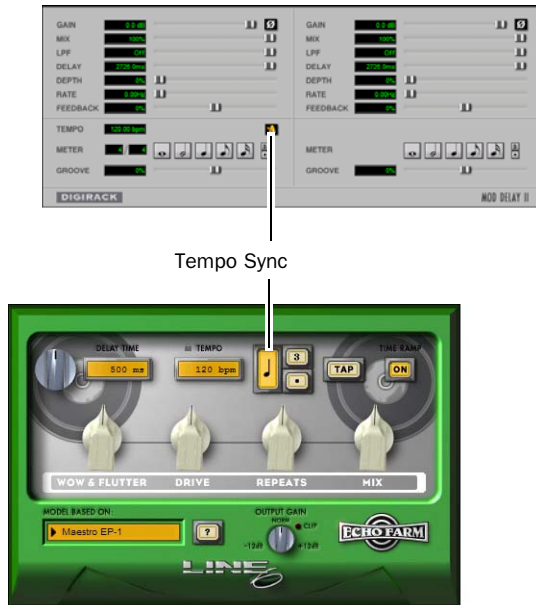

Tempo Sync in Digidesign ModDelay and Line6 Echo Farm

3 Tap the assigned Tap Tempo trigger (Function switch or Footswitch) in time with the music. At least two taps are needed to set the tempo; additional taps can result in a more accurate tempo setting.

The delay time of all Tempo Sync-enabled plug-ins change to match the system tempo. While tapping, the calculated tempo is also shown in the Status area of the screen.

Tips for Using Tap Tempo

The plug-in Tempo Sync switch enables/disables that individual plug-in's delay value from following the system tempo. Use the individual plug-in Tempo Sync switches to sync one, some or all delay plug-ins.

Tempos can range from 20 BPM (3,000 ms) to 300 BPM (200 ms). Some delay plug-ins offer different time divisions (such as 1/8th, 16th, or dotted) that you can select for variations based on the system tempo. Check your delay plug-ins to see if they support Tempo Sync and subdivision settings (most, but not all, do).

Snapshots and Tempo Sync

If you need a specific delay time every time a certain snapshot is recalled, store Tempo with snapshots. For details, see "Adding Tempo Data to Snapshots" on page 196.

Trigger Types

The following table lists the available trigger types and properties, along with a description of each.

Table 23. Trigger List, with default settings

Trigger Type	Property 1	Property 2	Description
Fader Above	Channel name/number	Fader level –inf to +12 dB (Default: –60 dB)	Fader moved above threshold level
Fader Below	Channel name/number	Fader level –inf to +12 dB (Default: –inf)	Fader moved below threshold level
Mute	Channel name/number	On (default) Off	Mute active/inactive
Solo/AFL	Any input, output, VCA, Solo In Place	On (default) Off	Solo/AFL active/inactive
Function Switch	Function Switch 1–8	Press (default) Release	On button press (down) On button release (up)
Footswitch	Footswitch 1, 2	Open Closed (default)	Footswitch input high Footswitch input low
GPI Input	GPI input 1–2	Open Closed (default)	GPI Input high GPI Input low
Recall Snapshot	Snapshot number and name		Event triggered by snapshot
Preview Mode		On (default) Off	Preview Mode active/inactive
Propagate Mode		On (default) Off	Propagate Mode active/inactive
Edit Mode		On (default) Off	Edit Mode active/inactive
Talkback		On (default) Off	Talkback active/inactive
Flip to Faders		On (default) Off	Flip to Faders active/inactive
Show Mode			Console Show Mode is active
Config Mode			Console Config Mode is active
System Start			System software initialized
Plug-In Rack Ready			Mirrors plug-ins rack Ready state

Action Types

The following table lists the available Action types and properties, along with a description of each.

Table 24. Action types

Action Type	Property	State	Behavior	Description
Target Next Channel				Selected Channel advances by one
Target Previous Channel				Selected Channel reverses by one
Copy Selected Channel				Channel copy operation
Paste to Selected Channel(s)				Channel paste operation
Mute Channel	Channel name/number	On Off Toggle (default)	Latch (default) While Active	Mute selected channel
Mute Group	Mute Group 1–8	On Off Toggle (default)	Latch (default) While Active	Toggle Mute group status
Mute All Stage Outputs		On Off Toggle (default)	Latch (default) While Active	Mute all stage outputs
Clear Solos				Mirrors console Solo Clear
Light Function Switch	1–8	On (default) Off Toggle	Latch While Active (default)	Lights Function switch
Flash Function Switch	1–8	On (default) Off Toggle	Latch While Active (default)	Flashes Function switch
Recall Snapshot	Snapshot number and name			Recall specified snapshot
Recall Next Snapshot				Mirrors Snapshot Next switch
Recall Previous Snapshot				Mirrors Snapshot Previous switch
Recall Selected Snapshots				Mirrors Snapshot Recall switch
Store to Selected Snapshot				Mirrors Snapshot Store switch
Preview Mode		On Off Toggle (default)		Activate/deactivate Preview Mode
Propagate Mode		On Off Toggle		Propagate mode active while trigger is true
Absolute Edit Mode		On Off Toggle (default)		Enters Edit mode when trigger is true; exits via Absolute when trigger goes false
Relative Edit Mode		On Off Toggle (default)		Enters Edit mode when trigger is true; exits via Relative when trigger goes false

Table 24. Action types

Action Type	Property	State	Behavior	Description
GPI Output	1-2	Open Closed (default) Toggle	Pulse, 0.3s (default) Latch While Active	Pulses or latches selected GPI Output
Flash Console Lights				Flashes console lights
Top Row Flip to Faders (D-Show Main only)		On Off Toggle (default)	Latch (default) While Active	Mirrors top encoder row Flip to Faders
Bottom Row Flip to Faders		On Off Toggle (default)	Latch (default) While Active	Mirrors bottom encoder row Flip to Faders (D-Show Main only)
Link Main and Sidecar(s) (D-Show Main only)	Faders Encoders Both	On Off Toggle (default)	Latch (default) While Active	Mirrors console function
Variable Groups Mode (VENUE Profile and D-Show only)		On Off Toggle (default)	Latch (default) While Active	Toggles Variable Groups Mode on/off (only if console config is 24-bus mode)
Input Safe Switch Mode				Cycles through Input Safe Switch modes
Tap Tempo				Sets the system tempo to synchronize delay plug-ins that support Tempo Sync
Cue on Mains				Maps Cue level (Solo/Monitor bus) level to the Mains fader; maps Mains to Output encoders 1-3
Cancel Operation				Mirrors console Cancel switch (and Esc key on keyboard)

Chapter 23: Synchronization

VENUE systems provide a set of MIDI-based synchronization features that allow automation and remote control of snapshots, and triggering of external devices when snapshots are recalled.

Automating Recall of Snapshots with MIDI Time Code

You can automate the recall of snapshots with MIDI Time Code (MTC). The VENUE system can trigger snapshots with internally generated MIDI Time Code, or it can read MIDI Time Code from an external source.

 For instructions on MIDI and other connections required for synchronization, see Chapter 2, “Configuring and Connecting D-Show.”

Generating MIDI Time Code

You can set the VENUE system to generate MIDI Time Code and automate the recall of snapshots based on MTC playback.

To generate MIDI Time Code from the VENUE system:

- 1 Go to the Options page and click the Snapshots tab.
- 2 Under MTC Mode, click Generate. MIDI Time Code generator controls appear at the bottom of the screen.

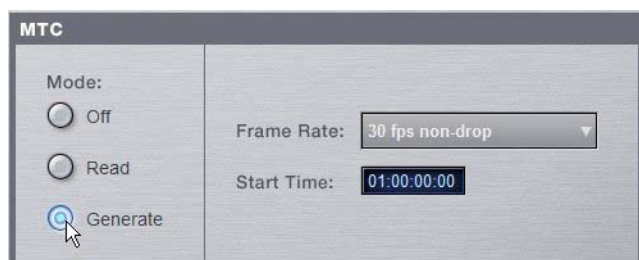

Setting the MIDI Time Code Mode

- 3 Choose the MTC Frame Rate from the Frame Rate pop-up menu (24 fps, 25 fps, 30 fps drop, or 30 fps non-drop).
- 4 If you want MTC playback to start at a different time than the currently displayed time, enter a start time in the Start Time field, and press Enter.

5 Control MTC playback from the MTC generator controls by doing any of the following:

- Start MTC playback by clicking the Play button.
- Pause MTC playback by clicking the Pause button.
- Stop MTC playback and reset to the Start Time by pressing the Stop button.



MIDI Time Code controls

Reading External MIDI Time Code

The VENUE system can slave to external MTC and automate the recall of snapshots based on the incoming MTC.

To read external MIDI Time Code:

- 1 Go to the Options page and click the Snapshots tab.
- 2 Under MTC Mode, click Read. A MIDI Time Code display appears at the bottom of the screen.

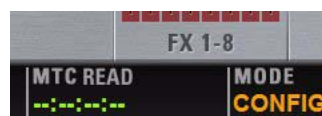

MIDI Time Code display

VENUE automatically detects the frame rate of the incoming time code (24 fps, 25 fps, 30 fps drop, or 30 fps non-drop).

The MIDI Time Code display indicates the following:

- When MIDI Time Code is not present, the display shows a series of dashes.
- When MIDI Time Code is present, the current time code value is shown in green.

Snapshot MIDI Time Code Display

When the system is set to generate or read MIDI Time Code, the Snapshots List shows time code values and a green Recall Enable indicator for each snapshot entry.



Snapshot ID	Description	MTC Value	Recall Enable
001	*Instructions1(seNots)*	01:00:00:00	Green
002	* Instructions 2 *	01:00:05:00	Green
003	All Plug-Ins sync'ed	01:00:10:00	Green
004	No plug-ins sync'ed	01:00:15:00	Yellow
005	One plug-in sync'ed	01:00:20:00	Green
006	Two plug-ins sync'ed	01:00:23:00	Green
007	-----	01:00:25:00	Green
008	Reset Demo	01:02:00:00	Green

Snapshots List showing time code values and indicators

Assigning Time Code Values to Snapshots

With the VENUE system set to generate or read MIDI Time Code, you can assign time code values to snapshots by entering values manually, or by capturing MTC playback values.

Manually Assigning Time Code Values to Snapshots

To manually assign an MTC value to a snapshot:

1 In the Snapshots List, double-click the MTC value you want to change.



003	Snap 003	01:00:11:19
004	Snap 004	01:00:20:15
005	Snap 005	01:00:23:19
006	Snap 006	01:00:29:23
007	Snap 007	01:00:35:08

Snapshot showing selected MTC value

2 Do one of the following:

- From the keyboard, type a new MTC value.
- or –
- Press the Left and Right Arrow keys to move the cursor between number fields, and the Up and Down Arrow keys to increase and decrease the selected value.

3 Press Enter or click another snapshot MTC value to accept the entry.

Capturing Time Code Values in Snapshots

To capture the current MTC value in a new snapshot:

- 1 With the system in MTC Read or Generate mode, start time code playback.
- 2 Do one of the following:
 - During playback, click the New button.
 - or –
 - Pause playback at the time code value you want to capture, and click the New button.

A new snapshot appears with the time code value at the time of creation.

To capture the current MTC value in an existing snapshot:

- Right-click the snapshot in the Snapshots list and choose Set Timecode To.

The time code value is updated to the currently displayed value.

Sorting Snapshots by Time Code Value

You can sort snapshots in the Snapshots list by Time Code value, so that they appear in chronological order.

 When chasing to MTC, snapshots will always recall in chronological order, regardless of their order in the Snapshots list.

To sort snapshots by their assigned MIDI Time Code value:

- Right-click any snapshot in the Snapshots list and choose Re-Sort All By Time Code.

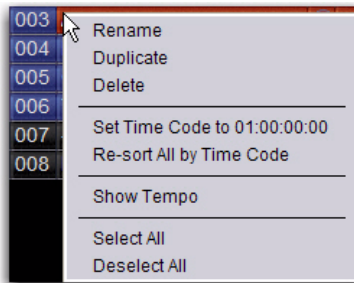

Right-click menu for items in the Snapshots list

Enabling Snapshots for Automated Recall

With time code values assigned to snapshots, you can then enable snapshots for recall with time code playback.

To enable snapshots for automated recall with MTC:

- Click the Time Code Recall Enable indicator on the right side of the Snapshots list. The indicator turns bright green to indicate that the snapshot is enabled for recall.



Snapshot enabled for automated recall with MTC

Chasing MIDI Time Code

With snapshots enabled for automated recall, the Chase MTC function needs to be engaged to allow automated recall to occur.

To initiate automated recall of snapshots:

- Click the Chase MTC button so that it is highlighted.
- Begin MTC playback by starting the internal generator (if set to MTC Generate) or the external device (if set to MTC Read).

When a recall-enabled snapshot's time code value is reached, the snapshot is recalled.

 Snapshot modes can affect MTC recall. For more information, see "MTC and Other Online Event Triggers" on page 194.

The Chase MTC button can be used to quickly take VENUE system offline from MTC-triggered recall in performance in the event of a change in timing, such as a missed cue or dropped verse. You can then advance manually to an appropriate snapshot, and re-enable Chase MTC.

 VENUE systems do not chase up to the current timecode value. If you start playback in the middle of a snapshot sequence, any prior snapshots will need to be recalled manually to update the console before beginning time code playback. For more information, see "Selecting and Recalling Multiple Snapshots" on page 184.

Remote Control of Snapshot Recall

The VENUE system can be set to recall snapshots in response to MIDI control messages sent from an external device such as an AV controller system. You can set the system to respond to control messages sent on any one of 16 available MIDI channels.

Snapshots are recalled when their snapshot number (1–999) is received in the form of MIDI Bank Select and Program Change messages. (See Table 24 on page 221.)

To enable recall of snapshots from an external device:

- Go to the Options page and click the Snapshots tab.
- Under MIDI, select the Snapshots Respond to Channel option, and choose the MIDI channel from the corresponding pop-up menu.



Snapshot MIDI respond option

The system listens on the specified channel for Bank Select and Program Change messages.



 The MIDI Snapshot Output Safe option does not affect this option. You can only turn off this feature by deselecting the "Snapshots Respond to Channel" option.

Table 24. MIDI Bank and Program Numbers for Snapshots

Bank	Program	Snapshot Number
0	0–127	001–128
1	0–127	129–256
2	0–127	257–384
3	0–127	385–512
4	0–127	513–640
5	0–127	641–768
6	0–127	769–896
7	0–103	897–999

 VENUE D-Show software stores Bank Select messages, so it is not necessary to send a Bank Select message prior to every Program Change message. You only need to send a Bank Select message when you want to recall a snapshot in a different bank from the previous snapshot.

Triggering of External Devices on Snapshot Recall

The VENUE system can be set to send MIDI Bank and Program Change messages whenever a snapshot is recalled, to trigger external devices whose cues are related to snapshots. You can set the system to send on any one of 16 available MIDI channels.

 MIDI output is automatically suspended while in Preview mode. For more information, see “Preview Mode” on page 192.

While it is possible to add Bank Select and Program Change messages to individual snapshots, this option lets you toggle messages on and off for all snapshots in one step. Using this option also ensures that the Bank Select and Program Change messages correspond to the snapshot number, even after snapshots are rearranged in the Snapshots list.

The Bank Select and Program Changes messages reflect the number (1–999) of the recalled snapshot. (See Table 24 on page 221.)

 VENUE systems always send a Bank Select message before every Program Change message, even if the bank number has not changed from the previous snapshot.

To enable triggering of external devices when snapshots are recalled:

- 1 Go to the Options page and click the Snapshots tab.
- 2 Under MIDI, select the Snapshots Send on Channel option, and choose the MIDI channel from the corresponding pop-up menu.



Snapshot MIDI send option

The VENUE system sends a Bank Select and Program Change message on the specified channel whenever a snapshot is recalled.

 The MIDI Snapshot Output Safe command does not affect the option to send on specific MIDI channels. You can only turn off this feature by deselecting the “Snapshots Send on Channel” option.

Sending MIDI Messages on Snapshot Recall

You can add up to 20 specific MIDI messages to each snapshot. These messages are sent whenever the snapshot is recalled. Sending of the messages is enabled with the MIDI scope control in the Snapshots window. For more information, see Chapter 21, “Snapshots.”

Synchronizing with Word Clock and Digital Audio Input

VENUE systems receive and output Word Clock (at a sample rate of 48 kHz ± 10ppm) for synchronization with a master clock generator (house sync) or other device that uses clock reference. VENUE systems can operate as a Word Clock master, or it can slave to Word Clock input.

The Word Clock In and Word Clock Out ports are located on the Mix Rack and FOH Rack.

Synchronizing with Digital Audio Input

VENUE systems automatically synchronize to Word Clock In. All digital inputs are sample rate converted and clocked to 48k and synchronized to the VENUE system clock.

This lets you connect a variety of digital sources (such as a DAT machine or CD player with digital outputs), directly to VENUE digital inputs.

For instructions on Word Clock and digital audio connections for synchronization, see Chapter 2, “Configuring and Connecting D-Show.”

Chapter 24: Using the Standalone Software

VENUE D-Show Standalone software lets you do all of the following to preconfigure performances, wherever you can use your laptop:

- Learn the basics of the VENUE D-Show software interface in preparation for working at a full VENUE system.
- Assign hardware I/O and routing, and name channels.
- Set channel input, EQ, dynamics, pan, and other settings.
- Create and maintain a library of setups, with access to nearly all parameters available on the control surface.
- Store and recall Snapshots, and configure Events.
- Use the Filing features to transfer Shows, Shows Folders, and plug-in presets to/from a compatible USB storage device to transfer data between the standalone software and VENUE.

 *Transferring data must be done to/from a compatible USB storage device such as a USB key disk or other external USB hard drive.*

Differences Between Standalone Software and a VENUE System

The Standalone software is nearly identical to that on a full VENUE system, with the following differences:

Audio Throughput

You cannot play audio through the Standalone software. Real-time audio requires the VENUE hardware.

Plug-In Editing

When a Show is transferred from a complete VENUE system, all plug-ins installed on the D-Show system are visible in the Standalone software as *offline* (unavailable) plug-ins. You can assign offline plug-ins to racks, and assign plug-in rack routing in the Standalone software, and save the routing in snapshots.

 *You cannot install plug-ins or adjust plug-in parameters unless you are working on the complete VENUE system.*

Hardware Configuration

In the Standalone software, you can simulate the hardware configuration of a destination system from the Devices tab of the Options page.

System Requirements

The following are the minimum system requirements for using the VENUE Standalone software:

- Computer running Windows XP Pro or XP Home Edition O/S, Service Pack 1 (Macintosh not supported)
- Minimum 1024 x 768 screen resolution
- Minimum 16-bit color graphics, 32-bit recommended
- Minimum 256 MB RAM, 512 MB recommended
- Minimum 200 MB of available hard disk space, 512 MB recommended
- CD-ROM drive for installation (unless installing from web-download)
- Available USB 1.1 or 2.0 port and compatible USB storage device (such as a flash disk, key disk or other external hard drive) for file transfer

Installation requires Windows Administrator permissions. Once installed, the software can be run under Admin or User accounts.

Installing the Standalone Software

To install the VENUE Standalone software:

- 1 Do one of the following:
 - Download the VENUE Standalone Software Installer from the Digidesign website (www.digidesign.com).
 - or –
 - Insert your VENUE Software Installer into the CD-ROM drive on your Windows XP-compatible computer.
- 2 Launch the installer and follow the instructions on-screen. The VENUE Standalone software requires no authorization.

Removing the Standalone Software

To remove the VENUE Standalone software:

- 1 Launch the Add/Remove Programs Control Panel.
- 2 Choose Digidesign VENUE, then follow the instructions on-screen.

Simulating a VENUE Configuration

You can use the Standalone software to simulate a VENUE system with any number of input and outputs. The corresponding inputs and outputs become available in the Patchbay, allowing you to prepare a show that can transfer directly to the destination system.

To simulate a VENUE system:

- 1 Launch the Standalone software.
- 2 Go to the Options page and click the Devices tab.
- 3 Right-click the console graphic and choose the type of console you will be working with.
- 4 Right-click an I/O graphic and choose the type of I/O (as available) and specify the number of Input and Output cards on the destination system.

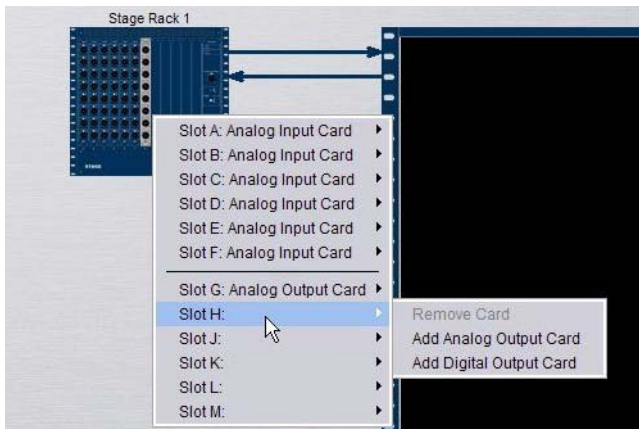

Adding Stage Rack inputs and outputs

Transfer and Filing Quick Start

The basic steps for using the Standalone software and data transfer are as follows:

- Save data to disk, then transfer it to an external USB storage device.
- Transfer data from the USB device, then load the data.

 For complete instructions on transferring data, see Chapter 20, “Shows and File Management.”

Save and Transfer Data from a VENUE System

To save and transfer data from the complete system:

- 1 Connect a USB storage device to a VENUE USB port.
- 2 Use the Save tab of the Filing page to save VENUE data to disk.
- 3 Go to the Filing page and click the Transfer tab.
- 4 Do one of the following to select the type of data to transfer:
 - To transfer all data, click the Console icon.
 - To transfer Console Settings, click the Settings icon.
 - To transfer Show Folders, click the Show Folders icon.
 - To transfer individual Shows, click the Shows icon.
 - To transfer Preset Folders, click the Preset Folders icon.
 - To transfer Presets for individual items, click the Built-In icon or the Plug-In icon and choose a processor, plug-in or Input Channel Presets item from the pop-up menu, or click the Scope Sets icon.
- 5 In the left column, select the items you want to transfer from VENUE to the portable storage device.



Transferring Show files from VENUE

- 6 Click the Transfer button.

Transfer and Load Data to the Standalone Software

- 1 Connect the USB storage device to your laptop. Make sure the drive is mounted before proceeding.
- 2 Launch the VENUE standalone software.
- 3 Go to the Filing page and click the Transfer tab.
- 4 Make sure your USB disk is available in the list at right.
- 5 Click the Console, Settings, Show Folders, Shows, Preset Folders, Built-In, Plug-In or Scope Set selectors to select the type of data you want to transfer.

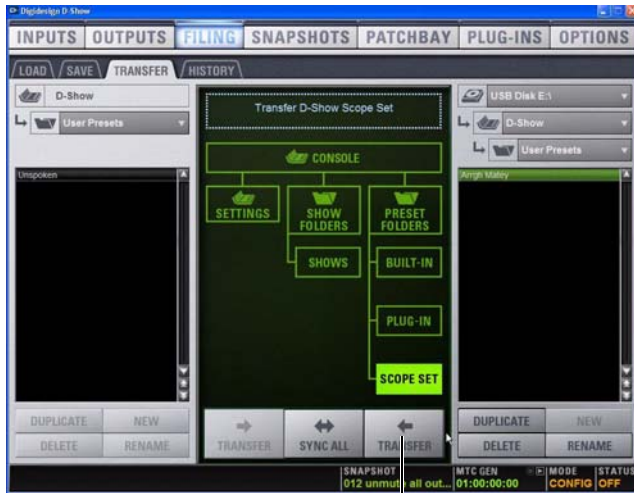

Click

Transferring a Scope Set for the standalone software

- 6 Click the Transfer button. The data is transferred from the USB device to the appropriate VENUE data folders on the laptop.
- 7 If you chose Console, data is automatically loaded and applied. If you chose any other data type, go to the Filing page and click the Load tab, and load the newly transferred data into the Standalone software.

Creating and Editing Shows and Presets

Use the techniques explained throughout this guide to assign routing, rename channels, and to configure other parameters. Then do the following to save and transfer your work to a complete system.

To save and transfer VENUE data from the standalone software to the complete system:

- 1 Connect a USB storage device to an available USB port on your laptop.
- 2 Using the Save tab of the Filing page, save data to disk.
- 3 Go to the Filing page and click the Transfer tab, and transfer saved data to a compatible USB storage device.
- 4 Connect the USB storage device to an available USB port on the complete system.
- 5 Use the Transfer tab of the Filing page to transfer the VENUE data from the USB storage device.
- 6 Use the Load tab of the Filing page to load the transferred data.

CD Transfer

The VENUE system provides a CD-ROM drive that can also be used as a source device for VENUE data transfer. (You cannot write data to the FOH Rack CD-ROM drive; it is read-only.)

To use a CD for transfer:

- 1 Using the Standalone software on a laptop or other computer, create and save a show.
- 2 Locate the VENUE data folder on the system drive.
- 3 Copy that folder and its contents to a CD-ROM. Make sure the folder is at the root level of the CD-ROM.
- 4 Burn or write the disc as a Windows-compatible CD-ROM.
- 5 Insert the CD-ROM into a VENUE CD-ROM drive.
- 6 In the Filing screen, select the CD-ROM drive as the source for file transfer.
- 7 When the transfer is complete, eject the CD-ROM.

 Leaving a disc in the CD-ROM drive of a VENUE system can slow down the response of some software screens, so it is recommended that you not leave any disc in the drive during a performance. This only applies to a VENUE CD-ROM drive (not the laptop on which you're running the standalone software).

Exporting System Information and Patchbay Information

With Standalone software, a complete system description and/or the contents of each Patchbay page can be exported to a text file. These can be useful for generating an input list (line list) directly from the system. For example, build and customize the Patchbay for an upcoming show, then export and print the channel names list for use during sound check.

To print a system description:

- 1 Go to the Options > System tab.
- 2 Click the Info button and follow the on-screen instructions to print a complete system description.

For more information, see “VENUE System Information Export” on page 112.

To export Patchbay names:

- 1 Go to the Patchbay page you want to export.
- 2 Click the Export Patch List icon in the upper right corner of the screen.

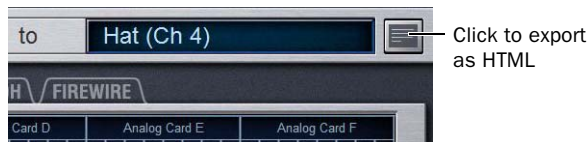

Export Patch List button

The Patchbay names appear in an open HTML file that you can save and print, or open in an HTML-compatible application for formatting or other modification. For more information, see “Patch List Export” on page 113.

Part VI: Specifications

Chapter 25: Mechanical Specifications

VENUE D-Show Main Unit Mechanical Specifications	
Maximum Height (front)	3.2 inches (81 mm)
Maximum Height (rear)	13.7 inches (347 mm)
Maximum Width (with endcaps)	51.7 inches (1313 mm)
Maximum Width (without endcaps)	49.5 inches (125.8 cm)
Maximum Depth	35.5 inches (895 mm)
Weight	121 lbs (55 kg)
Power Requirements	90–260 VAC, 50–60 Hz, 160 W
USB Ports (3)	USB 1.1
VGA Port	DB-15 mini-female (1024 x 768 resolution)
Footswitch Connectors (2)	1/4-inch TRS
FOH Link Connector (to FOH Rack)	MIL connector
Max FOH Link cable length	11 ft (3.35 m)
Console Link (CAN bus) Connectors (2)	XLR3-M (1 male, 1 female)
Console Link Cable Type	110-ohm (digital) cable
Max Console Link Cable Length	Single cable: 25 ft (7.6 m); Total length: 75 ft (22.9 m)
Maximum Height (front)	3.2 inches (81 mm)
Maximum Height (rear)	13.7 inches (347 mm)
Maximum Width (with endcaps)	51.7 inches (1313 mm)

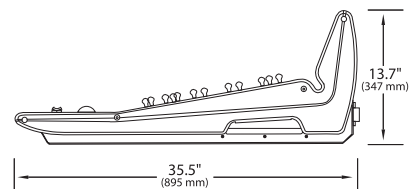
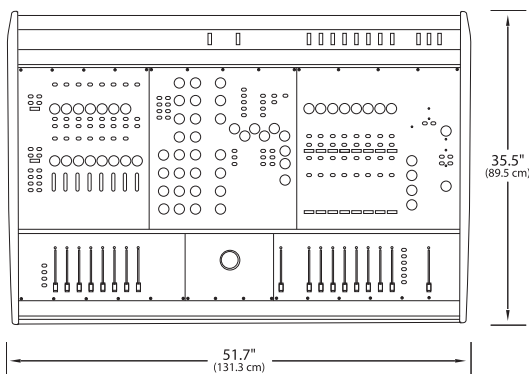

VENUE D-Show Main Unit dimensions

D-Show Sidecar Mechanical Specifications	
Maximum Height (front)	3.2 inches (81 mm)
Maximum Height (rear)	13.7 inches (347 mm)
Maximum Width (with endcaps)	28.7 inches (729 mm)
Maximum Width (without endcaps)	26.5 inches (673 mm)
Maximum Depth	34.8 inches (884 mm)
Weight	73 lbs (33.2 kg)
Power Requirements	90–260 VAC, 50–60 Hz, 120 W
Console Link (CAN bus) Connectors (2)	XLR3-M (1 male, 1 female)
Console Link Cable Type	110-ohm (digital) cable
Max Console Link Cable Length	Single cable: 25 ft (7.6 m); Total length: 75 ft (22.9 m)

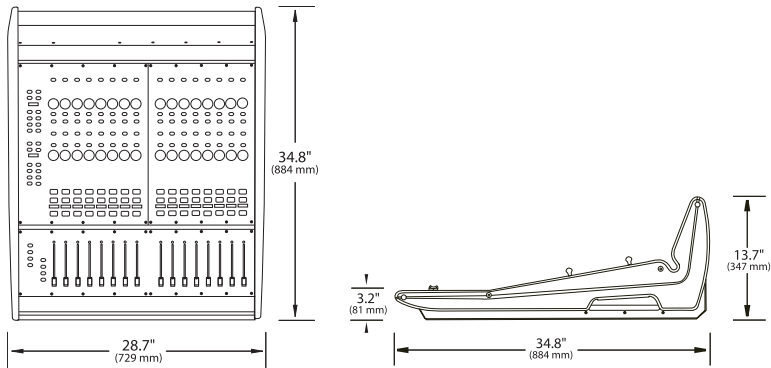

Sidecar dimensions

D-Show Main Unit plus Sidecar Mechanical Specifications	
Maximum Height (front)	3.2 inches (81 mm)
Maximum Height (rear)	13.7 inches (347 mm)
Maximum Width (with endcaps)	78.3 inches (1988 mm)
Maximum Width (without endcaps)	76.1 inches (1933 mm)
Maximum Depth	35.5 inches (895 mm)
Weight	194 lbs (88 kg)
Power Requirements (Main Unit)	90–260 VAC, 50–60 Hz, 160 W
Power Requirements (Sidecar)	90–260 VAC, 50–60 Hz, 120 W
Console Link Cable Type	110-ohm (digital) cable
Max Console Link Cable Length	Single cable: 25 ft (7.6 m); Total length: 75 ft (22.9 m)

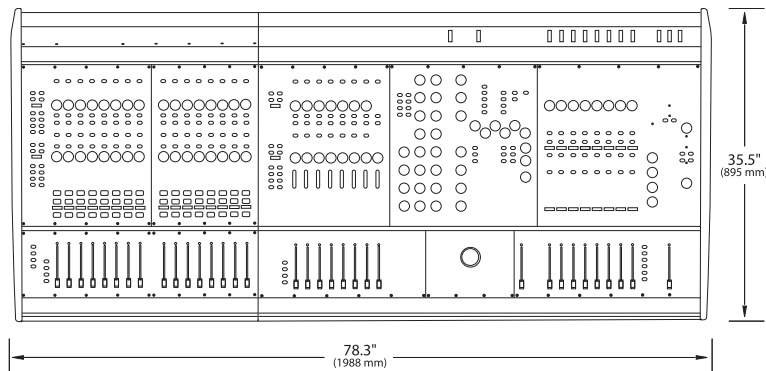

Main Unit plus Sidecar dimensions

FOH Rack, Stage Rack, and Mix Rack

See the *VENUE FOH Rack Guide*, *VENUE Stage Rack Guide*, or *VENUE Mix Rack Guide* for additional mechanical and audio specifications.

Chapter 26: Audio Specifications

VENUE D-Show System Audio Specifications	
Internal Sample Frequency	48 kHz
External Sample Frequency	48 kHz +/- 10 ppm (word clock input)
Processing Delay	less than 2.8 ms (96 channels, stage input through L-R bus to stage output)
Internal Processing	up to 48-bit, fixed point 288 dB internal dynamic range
Frequency Response	+/- 0.5 dB (22 Hz – 20 kHz BW, relative to 1 kHz)
THD + N	less than 0.01% Stage input to L-R bus, input gain @ min, -1 dBFS output, 20 Hz – 20 kHz BW
Dynamic Range	108 dB typ
Maximum Voltage Gain	84 dB (stage input to L-R bus, channel & L-R faders @ max)
Crosstalk	-100 dB typ (Adjacent stage inputs to L-R bus, @ 1 kHz)
Residual Output Noise	-90 dBu typ (22 Hz – 20 kHz BW)

VENUE D-Show Main Unit Headphone Output	
Connector	1/4-inch TRS unbalanced
Output Impedance	50 ohms
Max RMS Power Output (at +21 dBu:	(with 32-ohm phones) 20 mW
	(with 600-ohm phones) 130 mW

VENUE D-Show Main Unit Talkback Mic Input	
Connector	XLR3-F
Phantom Power	+15V @ 6mA (always on)
Sensitivity (fixed)	-20 dBu
Input Impedance	20K ohms

All specifications subject to change.

FOH Rack, Stage Rack, Mix Rack For audio specifications on FOH Rack, Stage Rack, or Mix Rack, see the guide that came with that rack. If your system includes any VENUE expansion options, see the guide that came with each option.

Chapter 27: Signal Flow Diagrams

VENUE D-Show Systems: Input Signal Flow

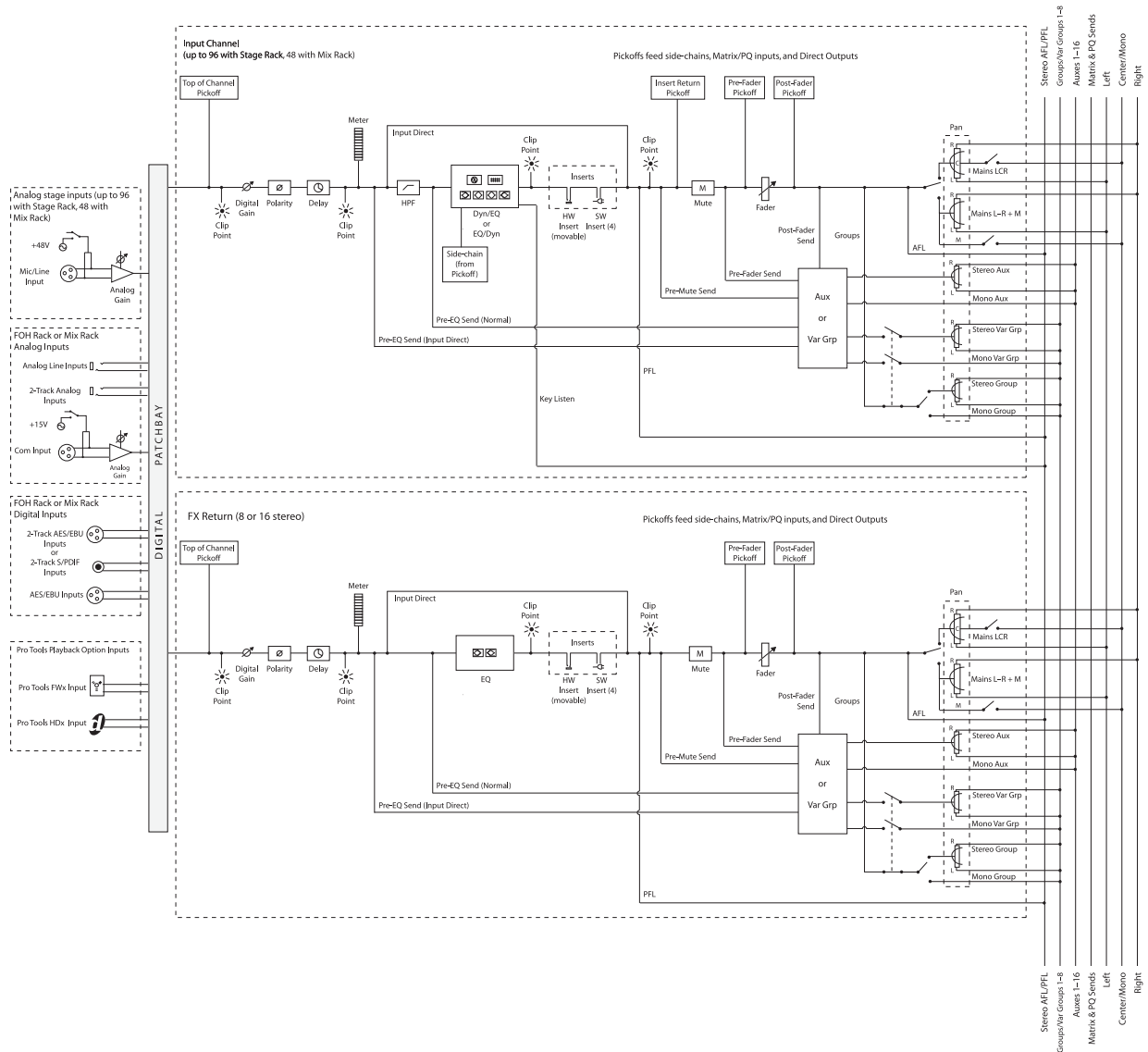

VENUE D-Show Systems: Output Signal Flow

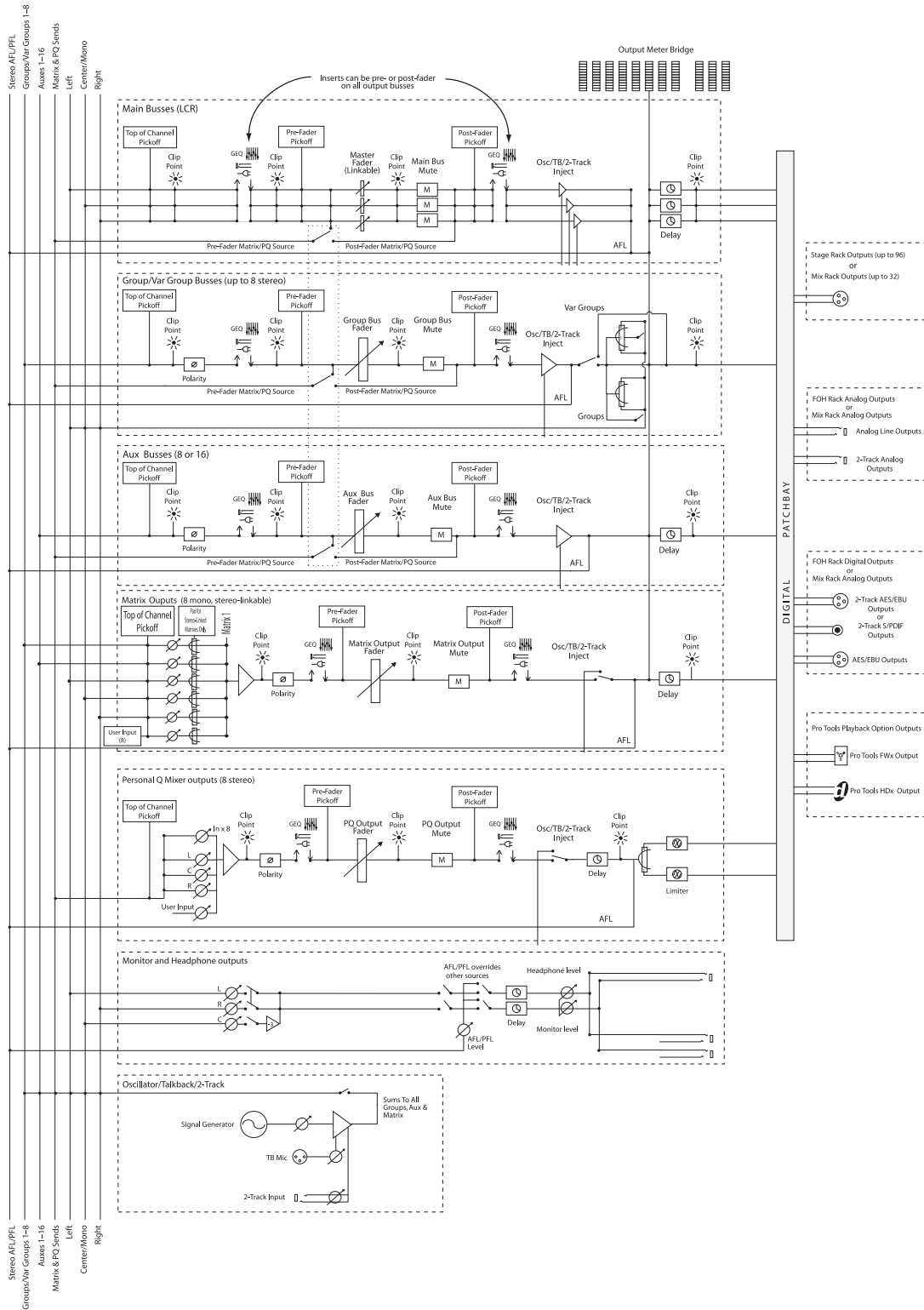

Chapter 28: Troubleshooting

This chapter provides troubleshooting and problem solving information. It includes a table of problems and solutions that provides answers to common questions, explains on-screen text messages, and refers you to specific sections later in this chapter or elsewhere in this guide for details and instructions.

Problem Solving

The following table provides descriptions of situations that may arise while operating a VENUE system and includes common questions, symptoms and error messages, along with possible solutions.

Table 29. Troubleshooting Errors and Messages

Symptom or Message	Possible Cause	Solution
Faders, Switches, Channels, and Devices		
Fader stuck	Fader path was blocked during startup calibration	Reset the unit on which the stuck fader resides by right-clicking the unit in the Options > Devices page and choosing Reset. If possible, wait for a silent portion of a performance to avoid unexpected gain changes upon reset. For details, see “Hardware Monitoring Window” on page 242).
Only faders and mutes are working	Backup personality is in effect	Wait for the system to recover and follow instructions on-screen to resume operations (see “Resuming Normal Operation” on page 240).
Channel meter Stereo LED is flashing	Indicates a difference of 12 dB or more between the two sides of the stereo signal.	Trim source levels or input gains to balance.
Cannot pan an Aux Send from the ACS	Aux panning is configured to follow channel pan	In the Options > Busses page, select the Follows Channel Pan option. Deselect for each Aux Send you want to pan independently from channel pan.
Startup and Restarts		
System failure and restart, then the Resume Operations dialog appears	The VENUE D-Show software has been forced to restart and the backup personality is now in effect.	Continue mixing using features available while the backup personality is in effect (see “In Case of System Failure” on page 239). Follow the instructions on-screen to resume operations after a restart (see “Resuming Normal Operation” on page 240).

Table 29. Troubleshooting Errors and Messages

Symptom or Message	Possible Cause	Solution
Repeated failures	An incompatible plug-in, a corrupted data file or application software, or a hardware error.	<p>Check to make sure you are using the most current versions of all your plug-ins (check with the manufacturers). If failures occur only when you try to use a certain plug-in, disable that plug-in and see if problems go away. Try re-installing plug-ins that are causing problems.</p> <p>Determine if a certain Show file causes the system to fail consistently. If so, delete that file and see if problems persist. For additional options, see “Performing a Soft Reset” on page 241.</p> <p>Clear the console from the Options > System Config page and see if problems persist.</p> <p>If necessary, you can reinstall D-Show software (see “Updating or Re-Installing” on page 243).</p> <p>If you suspect problems with the system hard drive, or the system software, you can do a complete restore (see “Full System Restore” on page 243).</p> <p>Power down all equipment and check all cards and cable connections and power supplies.</p>
Plug-Ins		
The plug-in racks need to be re-initialized	The racks have gone offline. The racks go offline whenever the backup personality is in effect, and after some conditions in which a plug-in or the DSP host failure causes significant problems.	Follow the instructions on-screen to reset the racks (see “Re-Initializing the Plug-In Racks” on page 240).
One or more plug-ins are unavailable	A Show was loaded that references plug-ins which are unavailable on the current system	<p>Install the plug-ins, if available (see “Installing and Authorizing Plug-Ins” on page 151).</p> <p>Remove or replace the plug-ins in the Show, or load a different Show file.</p>
	A plug-in is not fully compatible and is causing failures	<p>Check all plug-ins to make sure you are using the most recent versions. Go to Options > Plug-Ins and click the plug-in to display the version number.</p> <p>Try disabling plug-ins one-by-one to see if doing so eliminates problems (see “Enabling and Disabling Installed Plug-Ins” on page 154).</p>
Plug-in authorization dialogs appear every time the system starts or restarts	A plug-in is installed that needs to be authorized for demo or full use.	<p>Click Quit to dismiss the authorization dialog and continue starting up (the plug-in will be unavailable).</p> <p>Click Try to use the plug-in for a limited time in Demo mode.</p> <p>Click Authorize if you are ready to authorize a plug-in using an iLok. (See “Installing and Authorizing Plug-Ins” on page 151.)</p>
	A plug-in demo has expired	Uninstall the plug-in listed in the authorization dialog (see “Installing Plug-Ins Manually” on page 152).
Error Messages		
One or More Units have Failed	Bad or missing connection	<p>Check all cables and connections. Make sure digital grade XLR cables are being used to connect D-Show Main Unit and all Sidecar units (VENUE D-Show systems only).</p> <p>Check to make sure that the last Sidecar in the chain is properly terminated (VENUE D-Show systems only).</p>
	A unit needs to be reset	Reset the component in Options > Devices. If necessary, restart the VENUE system.
Plug-In Racks Need Reset	The racks have gone offline due to the backup personality being in effect, a plug-in has failed, or some circumstances have caused the DSP engines to require a reset.	Follow the instructions on-screen to reset the racks (see “Re-Initializing the Plug-In Racks” on page 240).

Table 29. Troubleshooting Errors and Messages

Symptom or Message	Possible Cause	Solution
Power Supply Alert	A power supply is failing or is not plugged in. A power supply jumper switch is set incorrectly.	Click Review to show the Options > Devices page. Reset units as needed (see “Hardware Monitoring Window” on page 242).
Control Surface Change	A unit Bus ID has changed, a new console has been detected, or a new sidecar has been detected.	Click to clear the message. Check unit Bus IDs to make sure input channel strips are arranged as desired.
Date & Time Check	System clock setting for time of day should be checked against current time.	Check and reset system time in the Options > Misc page. Incorrect system time can affect data transfer and plug-in authorizations. If clock problems persist, the battery may need to be replaced in the system rack or console (contact VENUE support if you suspect this is occurring).
Sample Rate Conversion Alert SRC OFF LEDs flashing (Systems with DSI option only)	A sample rate mismatch or lack of clock has been detected at a digital input.	No immediate action required; automatic sample rate conversion maintains digital throughput, allowing you to check settings and connections between D-Show and external digital devices later. For more information on digital connections and synchronization, see “Digital Inputs and Sample Rate Conversion” on page 19.
Hardware Monitor Alert	The system has detected a hardware component that is performing above or below its hardware specification.	Click HW Monitor to access the Hardware Monitor Window for the device. See “Hardware Monitoring Window” on page 242.

In Case of System Failure

VENUE systems include multiple redundancy and fail-safe routines that help protect against problems that could interrupt audio. These include the ability to maintain mix control even if a failure occurs, to reset software and hardware components, and to completely reset and reinstall the system software.

For maximum protection, Redundant Power Supplies are available. For systems that utilize one or more VENUE hardware racks, redundant Snake options are available to provide additional backup system communication for uninterrupted operation.

Maintaining Mix Control

If at any time the system fails, or if the system is reset or restarted, the VENUE D-Show software backup mode is automatically engaged to maintain audio throughput and essential mix control.

While the backup personality is engaged, a dialog appears on-screen in the banner display. The system then begins to reset itself in the background, while you can continue to use the faders and mute switches to perform basic mixing. Plug-Ins continue to process audio but their controls cannot be changed until the process is complete.

Features that Remain Active

The following essential mixing features remain available while the backup personality is engaged:

- Bank Input Channels (Banks A–D); adjust levels and mutes. (FX Returns are banked independently of Input Channels.)
- Bank to FX Returns; adjust faders and mutes
- Bank Output faders; adjust faders and mutes
- Control VCA masters, including VCA mutes, and have all members of the VCA group reflect VCA adjustments
- Display the correct name for any fader in its LCD display, even while banking
- Meter input signals on the channel input meters, and meter bus outputs on the assignable meters. Meter mode selection buttons remain active on meterbridge (however, Meter mode does not automatically follow output selection, if configured to do so).
- Compressor and gate meters remain active for all Input Channels (however, Comp In and Gate In switches are not available)
- Meterbridge System Status LEDs turn off (VENUE D-Show and Profile only)
- Channel select is disabled for all inputs and outputs
 - ◆ Switch the Mute Group Masters, and see the effect on the channels with member-mutes (flashing mute switches)
 - ◆ All LCD displays illuminate (orange)
- Adjust near-field monitor and headphone levels

Unavailable Features

The following features are unavailable while the backup personality is in effect:

- Use the ACS
- Modify any other mixing parameters apart from faders and mutes (for example auxes)
- Use solos or Solo In Place
- Change the input or output routing, or order of inputs
- Make stereo, or unlink stereo to discrete mono channels
- Channel Control and Flex Channel
- Change bus or group assignments, or Group spill
- Change VCA membership, VCA spill, or show VCA members
- Change names or access any Filing functions
- Reconfigure any system parameters in the Options screens
- Access GEQs on the faders (GEQs continue to process audio in backup mode)
- Adjust Cue via Mains Fader (Mains fader reverts to Mains)
- Adjust the parameters of any existing Plug-In
- All LED indicators (except meters) and output fader CAL lights go dark and are inactive

Resuming Normal Operation

(Exiting the Backup Personality)

When the system has recovered and is prepared to return to normal operation, the Ready to Resume dialog appears on-screen.

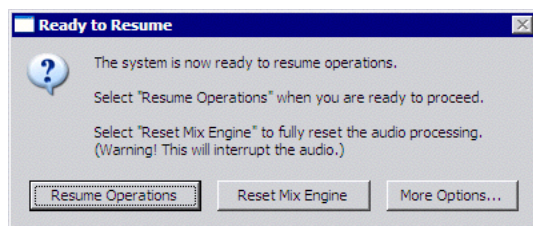

Ready to Resume dialog

Choices in the Ready to Resume dialog give you options for how and when critical functions are brought back online. Utility functions are also provided for reset and diagnostics, as described in the following sections.

- ⚠ *Because this process can interrupt audio throughput, wait for a silent portion of the performance before confirming (such as a break between songs, intermission, or similar).*

Resume Operations Use this option if you need to wait for a break in a performance to complete the resumption of normal operations.

Reset Mix Engines Use this option to do a full system reset in one step. All operations and controls including the plug-in racks return to full operation. This is the fastest way to resume operations, but it may interrupt audio.

More Options Use this option to clear the console (reset, or “zero” the board), or to perform hardware diagnostics.

Resume Operations

This option begins the process of resuming operations and lets you control precisely when the plug-in racks are re-initialized.

To begin the Resume Operations process:

1 Click Resume Operations. The console resets all parameters and configuration settings. When completed, the Plug-In Racks Reset dialog appears to let you initiate the process of re-initializing the plug-in racks.

2 Reset the plug-in racks (see next).

Re-Initializing the Plug-In Racks

The plug-in racks are taken offline during a Resume Operation process. Whenever the plug-in racks go offline they will need to be reinitialized to resume normal operation.

- ⚠ *Do not reset the racks until there is a long enough break in the performance that the rack can be fully rebuilt with no signal passing through. This is especially important when using crossover plug-ins or gain-attenuating plug-ins.*

The following conditions apply when resuming operations

- When offline, plug-ins on Input Channels and FX Returns continue to pass and process audio using their settings at the time the racks went offline.
- Offline plug-ins on output channels and busses are muted.
- You will not be able to adjust plug-ins settings until the racks fully re-initialize.
- Once the racks begin to reinitialize, plug-ins are unavailable and do not process audio.
- During reinitialization, plug-ins are loaded into rack slots according to the last loaded Show file; plug-in racks are turned off (all assigned plug-ins are made inactive).
- When all plug-ins have loaded and the racks initialized, the system displays a dialog alerting you that the racks are ready to be brought back online (reactivated). This is provided as a final precaution against sudden changes to audio when plug-ins resume processing.

Shortly after you confirm that you want the racks brought back online, plug-ins resume processing audio and all parameters become available for editing.

To re-initialize (reset) the racks:

1 In the Plug-In Racks Reset dialog, click Reset to begin the plug-in rack re-initialization.



Resetting the plug-in racks

When this step is completed, the Plug-In Racks are Ready dialog appears alerting you that the plug-in racks are ready to be re-activated.

2 Click Use Racks to confirm that you want the racks to be re-initialized. Status is shown on-screen. After the process is complete, the console and all plug-ins are operational again.

Reset Mix Engines

Use this option to do a full system reset in one step. Reset Mix Engines resumes all operations automatically, including the console, settings, and plug-in racks.

 *Audio may be interrupted or may change levels during this reset procedure.*

To reset the Mix Engines and all operations immediately:

- Click Reset Mix Engines in the Ready to Resume dialog.

Operations are brought back online; no further interaction is required (no warning or confirmation dialogs appear).

More Options

Additional options are provided to clear the console, or to run DigiTest (hardware diagnostics).

To access additional options:

- Click More Options.

After clicking More Options, a dialog is displayed that provides the following options.

Clear Console

- Click Clear Console to reset all parameters on all channels to their factory default settings.

Run DigiTest

DigiTest is hardware diagnostics software for VENUE systems. Only use DigiTest at the request of a Digidesign technician to diagnose specific hardware problems.

Performing a Soft Reset

If your VENUE system ever needs to be reset, do the following:

To restart the system:

- Go to the Options > System page.
- Hold Default (Alt) and click the Shut Down button.



If restarting the system does not correct a problem, you may have to reset hardware components, identify and remove any incompatible plug-ins, or reinstall VENUE D-Show software using the System Restore CD.

Additional Reset Options

Additional shortcuts are provided while restarting the system, which let you do the following:

- Back up the current show settings and clear the console. Use this option if you suspect an auto-saved setting has become corrupted. This lets you save your most recent settings and clear the console without having to do a full system restore.

– OR –

- Launch into Explorer, to be able to manually manage software components. Use this option to troubleshoot the system if problems arise early in the startup process and persist through repeated restarts.

Backup and Clear Console

To backup and clear the console at restart:

- Start or restart the system.
- Watch the screen closely during the startup process. As soon as the cursor becomes visible (and before the VENUE D-Show Software logo screen appears) press and hold the C key on the computer keyboard. Continue to hold the C key (do not press it repeatedly).
- A dialog appears that lets you choose to backup your auto-saved settings and clear the console, or to continue and load settings normally.

 *If you press the C key too early in the startup process, the USB keyboard is reset instead of calling the Backup and Clear dialog. If you do not see the backup and clear dialog, repeat the restart process and try again.*

Startup in Explorer

To start up the system in Explorer (bypassing VENUE D-Show software):

- 1 Start or restart the system, as necessary.
- 2 Watch the screen closely during the startup process. As soon as the cursor becomes visible (and before the VENUE D-Show Software logo screen appears) press and hold the E key on the computer keyboard. Continue to hold the E key (do not press it repeatedly) until you see the Explorer desktop.
- 3 From Explorer, you can manually find and delete suspect data files, plug-ins, or perform other file management tasks.

 *If you are unsure about how to troubleshoot a computer and its files, it is recommended that you contact Digidesign VENUE customer service.*

Hardware Monitoring Window

VENUE systems provide the Hardware Monitoring window in which performance of hardware components can be viewed and monitored.

 *The Hardware Monitoring window is not available in the Standalone version of VENUE D-Show software.*

Accessing Hardware Monitoring

To access the Hardware Monitoring window, do any of the following:

- Press Ctrl+Shift+M at any time to open the Hardware Monitoring window.
- In the Options > Devices page, right-click on a unit and choose Hardware Monitoring in the pop-up menu. This opens the Hardware Monitoring window for the selected device.
- If the Hardware Monitoring Alert dialog appears on-screen, click to select Show Hardware Monitor. The Hardware Monitoring Alert dialog for the problem device appears automatically and identifies the reading that is out of specification.

The Hardware Monitoring Alert window is only displayed once per device (should a problem ever be detected with that device).

The following is an example of the Hardware Monitoring Alert:



Hardware Monitoring Alert

Should a problem occur with any of the components in your system, the Hardware Monitoring window will provide information that will be useful in troubleshooting while in contact with Digidesign VENUE customer service.

Resetting Hardware Components

(VENUE D-Show and Profile Systems Only)

Some VENUE hardware can be reset from the Options > Devices screen, or by power-cycling the component. It is recommended that you perform a reset if, for example, the Hardware Monitor Alert dialog appears, or if a connected device stops communicating with the rest of the system.

Indication

The system software will display error messages alerting you if a device fails or is no longer available.

The system remembers the last hardware configuration used. If it doesn't find all units at the next startup, it displays those units as grayed out in the Options > Devices page. Units remain offline (and the system displays error messages alerting you to their absence) until either the units are powered up and come online, or you tell the system to forget the offline units by right-clicking the missing devices and choosing Forget.

To reset system hardware:

- 1 Put the system in Config mode.
- 2 Go to the Options page and click the Devices tab.
- 3 Right-click any displayed hardware components:
 - Console
 - Inputs section
 - ACS sections
 - Outputs section
- 4 Choose Reset.



Resetting a unit in the Options > Devices page

Using the System Restore CD to Update or Restore the System

One copy of the System Restore CD is included with each system. The System Restore CD provides software installers to update or restore a system.

Updating or Re-Installing Updating or re-installing system software lets you replace Digidesign software (including new installers for factory-installed plug-ins) but preserve any saved Shows and Presets. Use this option to update system software or firmware, or to re-install system software or the installer for a factory-installed plug-in.

Factory-installed VENUE D-Show plug-ins are immediately available to be reinstalled from the Options > Plug-Ins page. Plug-ins that cannot be re-installed from the Options > Plug-Ins page must be reinstalled from their installer discs.

Full System Restore Performing a full system restore completely uninstalls system software before replacing it with new software. All data folders and files are removed. Be sure to transfer and archive needed data before performing a system restore. Factory plug-in installers will be available automatically, as part of the system restore. All other plug-ins must be re-installed from their installer discs.

 A System Restore CD and CDs of any plug-in installers should be kept with the system at all times.

To start, update, or restore a system using the System Restore CD:

- 1 Make sure outputs, speakers, and power amps are muted.
- 2 Insert the System Restore CD into the VENUE system CD-ROM drive.
- 3 Go to the Options > System page.
- 4 Alt-click the Shut Down button.
- 5 Click to restart the system, then press and hold F10 on the keyboard until either of the following occur, depending on your hardware:
 - If the system begins to boot off the Restore CD, proceed to step 4.
 - If the Restore CD text screen appears, release F10 and use the Up and Down Arrow keys to select the CD drive, then press Enter. This launches using the software on the inserted System Restore CD. Continue to step 4.

 Some models of USB keyboards require repeated pressing of F10 (holding it down in between pressings) to register.

- 6 Do one of the following to update or restore system software:
 - To update system software while keeping any Show files and Preset files on the system, press “u” (lower-case). In the Update confirmation screen, press Shift+U (upper-case) to proceed. Follow the on-screen instructions to begin installation.
 - or –
 - To fully restore the system (completely removing all files on the system), press “r” (lower-case). (Or press P to return to the previous screen.) When the Restore confirmation dialog appears, press Shift+R to proceed. Follow on-screen instructions to complete the system restore operation.
- 7 If prompted, select an option in the Ready to Resume dialog as appropriate (see “Resuming Normal Operation” on page 240). Follow any additional instructions on-screen for plug-ins or authorizations.
- 8 Remove the System Restore CD from the CD-ROM drive.
- 9 Re-install any plug-ins from their installer discs, as necessary.

 Before re-installing plug-ins after updating system software, check if there is a more current version available. If an updated version of a plug-in is available, install it from its installer CD-ROM.

To cancel without changing any installed software:

- Press E to exit from the Welcome to VENUE System Restore screen. The system resumes starting up using the currently installed version.

 *If you cancel a full system restore or an update, you may experience installation errors about unavailable space. If this occurs, repeat the system restore process, making sure to complete it in one pass.*

Updating Firmware

During an update or system restore, the system checks for new firmware. If newer firmware is found on the System Restore CD, it is installed while the system starts up.

Reinstalling Plug-Ins After Restoring the System

The System Restore CD reinstalls all system software and factory-installed plug-in installers only. DigiRack Plug-ins and any additional plug-ins from Digidesign or its Development Partners must be re-installed separately. (Factory-installed plug-ins will be available from the Previous Installs selector to re-install immediately after a system restore; other plug-ins must be completely re-installed.)

 *For instructions on re-installing plug-ins, see Chapter 18, "Plug-Ins."*

Part VII: Reference

Chapter 29: Console Reference

This chapter describes the ports and connectors on the VENUE D-Show Main Unit console.

VENUE D-Show Console

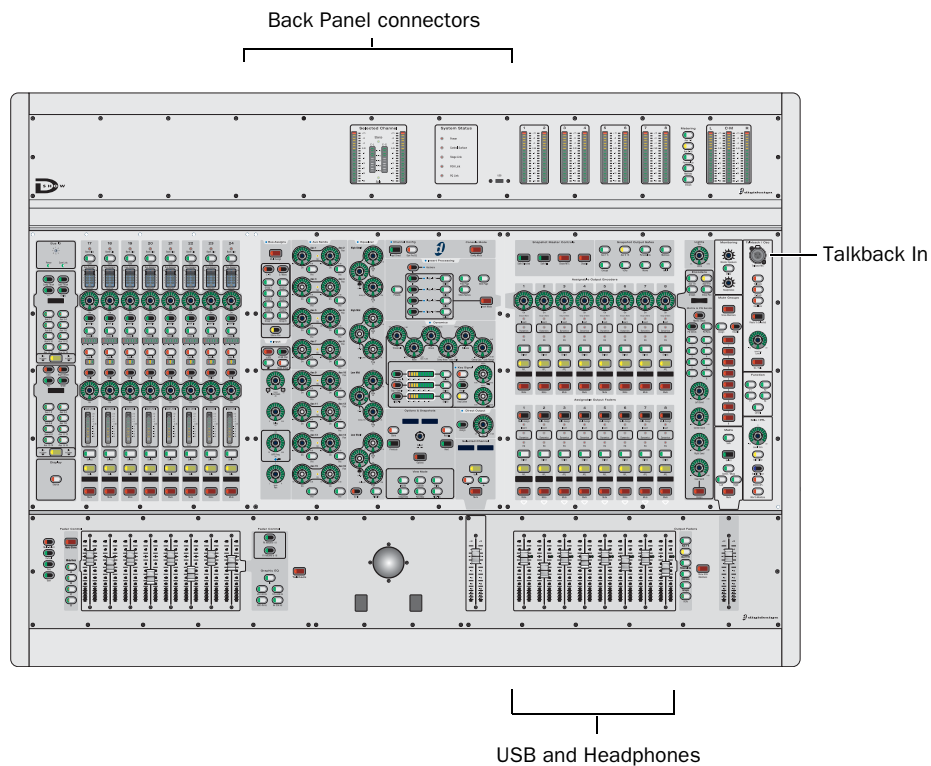



Figure 15. Main Unit top panel sections

USB Ports

A USB 1.1 port is provided on the front panel. Use this USB port for iLok Smart Keys or any other USB device such as a key disks. Another USB port is provided on the back panel.

 For faster data transfer to and from USB storage devices, use the USB 2.0 ports on the Mix Rack and FOH Rack.

Headphone Connector

The headphone connector on the front of the console is a standard 1/4-inch stereo (TRS) headphone jack. The connector is fed by the Monitor bus.

D-Show Main Unit Back Panel

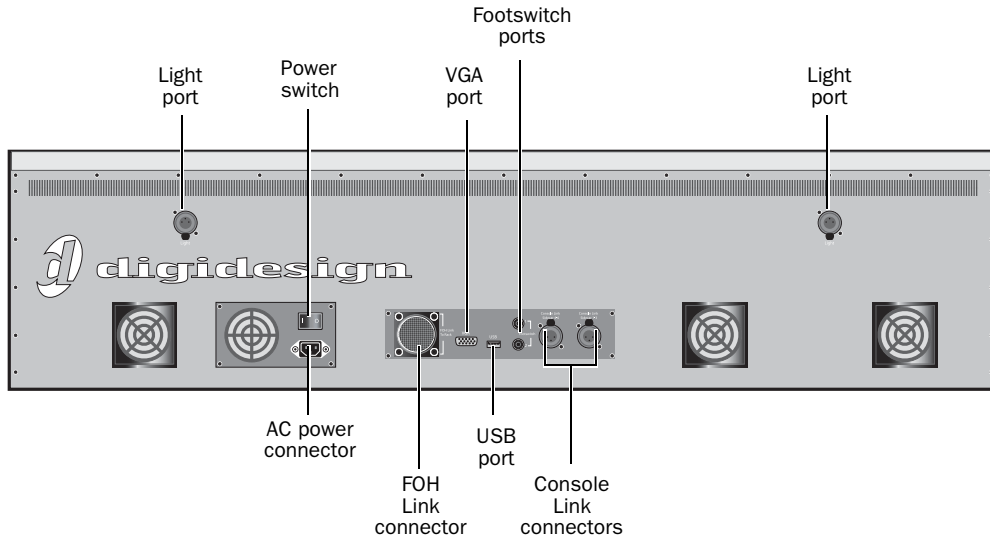

Figure 16. Main Unit back panel

Power Switch

The Power switch applies power to the D-Show Main Unit.

AC Power Connector

The AC Power connector accepts a standard AC power cable. The D-Show Main Unit is auto-power selecting (100V to 240V) and automatically works with a standard modular power cord when connected to an AC receptacle in any country.

FOH Link Connector

The FOH Link connector accepts the FOH Link cable supplied with the FOH Rack. This cable provides all the data and audio connections between the D-Show Console and the FOH Rack.

VGA Port

The VGA port accepts a standard VGA display connector for the D-Show system monitor. A 15-inch XVGA display with a minimum resolution of 1024 x 768 is recommended.

USB Port

The USB port on the back panel of the Main Unit is a USB 1.1 port. This port supports iLoks, USB key disks, and USB keyboards.

Footswitch Ports 1 & 2

The Footswitch ports on the back panel of the Main Unit are standard 1/4-inch TRS connectors. The Footswitch function is set in the Interaction tab of the Options page.

Console Link Connectors (Sidecar 1–3, 4–6)

The Console Link connectors use standard AES/EBU digital XLR cables (*not* microphone cables) to connect the Main Unit to Sidecars. Sidecars 1–3 are daisy-chained and connected to the first connector.

Sidecars 4–6 are daisy-chained and connected to the second connector.

Light Ports (2)

The two powered light ports support optional 3-pin XLR console lights.

D-Show Sidecar

Sidecar Top Panel

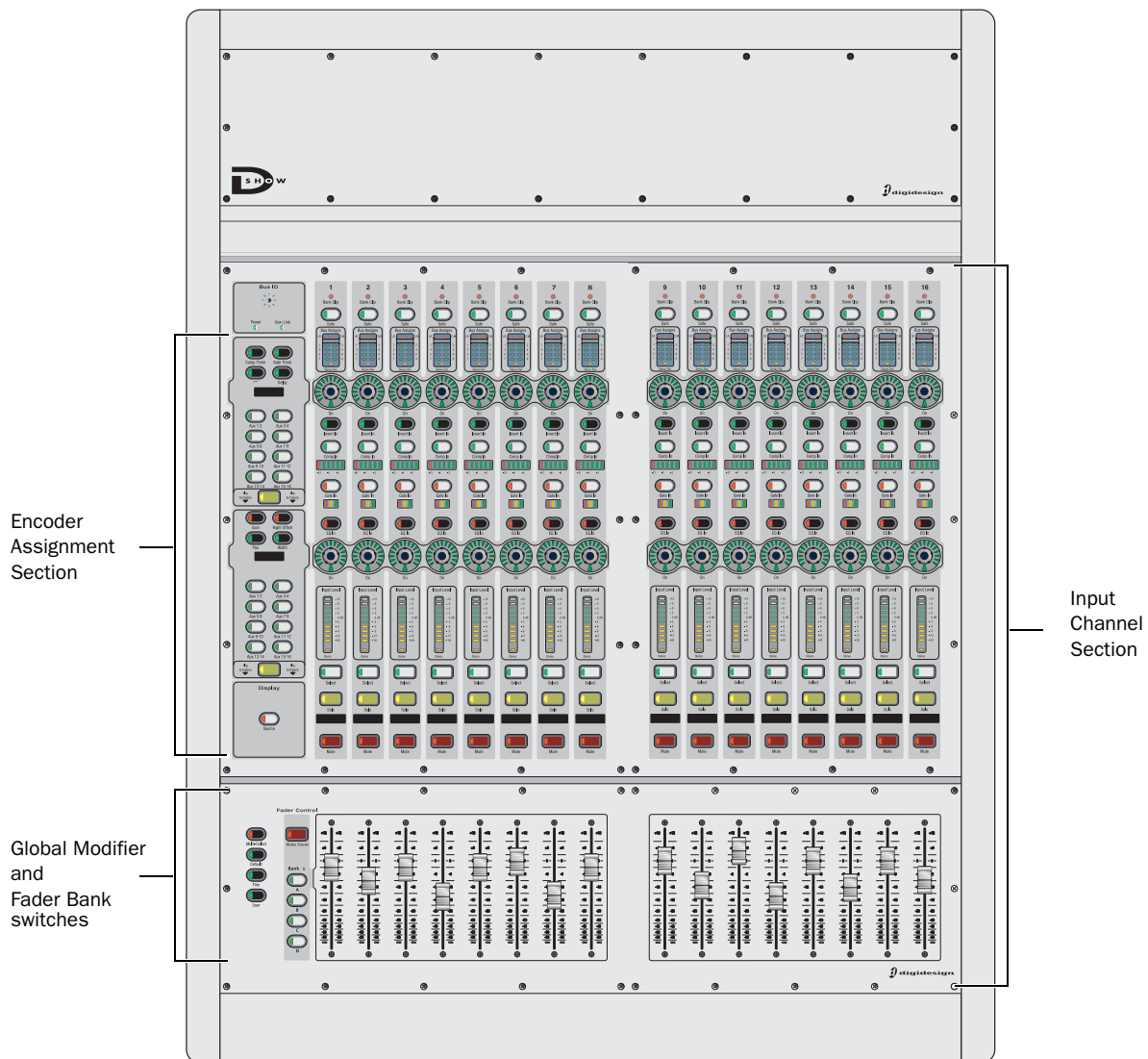

Sidecar top panel

Input Channel Section

Each Sidecar unit has 16 channel strips that provide access to Input Channels. Input Channels are used to control input signals from the Stage Rack, FOH Rack (or Mix Rack) and Pro Tools playback options.

Encoder Assignment Section

Each Sidecar unit includes Encoder Assignment controls that are used to assign functions to the two rows of rotary encoders. These controls mirror the state of the same controls on the Main Unit.

Global Modifier and Fader Bank Switches

Each Sidecar unit has a set of Global Modifier and Fader Bank switches that mirror the function of the corresponding switches on the D-Show Main Unit.

Sidecar Back Panel

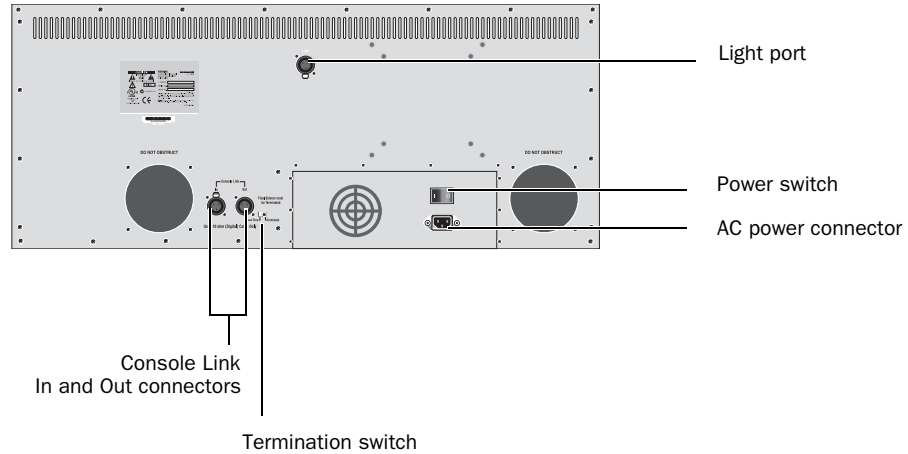

Sidecar back panel

Console Link In and Out Connectors

The Console Link In and Out connectors use 110-Ohm AES/EBU (Digital) XLR cables to connect the Sidecar to the Main Unit or to other Sidecars.

⚠ All Console Link connections require 110-Ohm AES/EBU (Digital) cable. Do not use standard audio-grade microphone cable to connect the Main Unit and Sidecars.

Termination Switch

The Termination switch is used to terminate the Console Link chain. On the last Sidecar in a chain, this switch should be set to "Terminate." On all other Sidecars, this switch should be set to "Thru."

Power Switch

The Power switch applies power to the D-Show Sidecar.

AC Power Connector

The AC Power connector accepts a standard AC power cable. The D-Show Sidecar is auto-power selecting (100V to 240V) and automatically works with a standard modular power cord when connected to an AC receptacle in any country.

Light Port

The powered light port supports an optional 3-pin XLR console light.

Chapter 30: ECx

VENUE systems include ECx Ethernet Control. ECx lets you control a VENUE system remotely over an Ethernet network, using compatible wired or wireless network equipment (purchased separately).

ECx Capabilities and Features

ECx provides the following:

- Remote control of a VENUE system from a client computer, including a laptop or Tablet PC
- Exact duplication of VENUE D-Show software on the remote client computer

ECx Components

The ECx components of your VENUE system include the following items:

- ECx Control (pre-installed)
- Ethernet cable for connecting the ECx card to your client computer, wireless router, or wireless access point device
- ECx Ethernet Control Software installer CD-ROM (containing ECx host and client software)

System Requirements

The following are required to use ECx with your VENUE system:

- A Digidesign-qualified router or wireless access point (WAP) device
- A client computer running Digidesign-qualified Windows or Mac OS X software with wired or wireless Ethernet capability.
- For wireless communication with ECx, 802.11g capable devices are recommended.

Digidesign can only assure compatibility and provide support for hardware and software it has tested and approved.

For complete system requirements and a list of Digidesign-qualified computers, operating systems, and wireless devices, refer to the latest compatibility information on the Digidesign website:

www.digidesign.com/compatibility

Installing ECx Host Software

The ECx host software enables your VENUE system to communicate with computers running the remote client software.

To use ECx Ethernet Control, you must do the following:

- Install the ECx host software on your VENUE system.
- Install the ECx client software on your remote computer.

If you need to uninstall the ECx host software from your VENUE system, see “Uninstalling ECx Host Software” on page 252.

If you need to re-install the ECx host software, (after a System Restore or an Update), see “Reinstalling ECx Host Software” on page 252.

After you install the host and client software, see “Overview of ECx Setup and Configuration” on page 253 for information on setting up your VENUE system and client computer for remote operation using ECx.

Installing ECx Host Software

The ECx Ethernet Control Software installer disc contains the ECx host software. This software enables your VENUE system to communicate with computers running the remote client software.

To install ECx host software on your VENUE system:

- 1 Insert the ECx installer disc in the system CD-ROM drive.
- 2 Do one of the following to put your system into Config Mode:
 - Press the Console Config switch on the console.
 - or –
 - Double-click the Mode box in the bottom-right corner of the screen.
- 3 Go to Options > System page and click Update.
- 4 Click Yes to exit VENUE D-Show software and begin the installation.
- 5 After the installation is complete, the system restarts.

 *When you perform an Update or a System Restore of your VENUE system, you must reinstall the ECx host software. See “Reinstalling ECx Host Software” on page 252.*

Installing the ECx Client Software

The ECx Ethernet Control Software installer CD-ROM contains remote control applications for both Windows and Mac.

Installing the ECx Client in Windows

To install the ECx Control client application (“UltraVNC”) in Windows:

- 1 Insert the ECx installer disc in the computer CD or DVD drive.
- 2 Open the Windows Client folder.
- 3 Double-click the “UltraVNC-Viewer.exe” file.
- 4 Follow the on-screen installation instructions to complete the installation.

Installing the ECx Client on Mac

To install the ECx Control client application (“Chicken of the VNC”) on Mac:

- 1 Insert the ECx installer disc in the computer CD or DVD drive.
- 2 Open the Mac OS X Client folder.
- 3 Double-click the “cotvnc-20b4.dmg” file.
- 4 In the window that opens, drag the “Chicken of the VNC” icon to copy it to a location on your hard drive.

Uninstalling ECx Host Software

If you need to uninstall ECx software from your VENUE system, you can do so from the system desktop.

To uninstall ECx host software from your VENUE system:

- 1 Do one of the following to put your system into Config Mode:
 - Press the Console Config switch on the console
 - or –
 - Double-click the Mode box in the bottom-right corner of the screen.
- 2 Go to Options > System.
- 3 Hold the Control key and click Shut Down to go to the system desktop.
- 4 Locate and double-click the ECx host software uninstall program (C:\Program Files\D-Show Ethernet Control Software\Uninstall.bat).

The ECx host software is uninstalled, and the D-Show software automatically restarts.

 *The ECx folder will remain on your VENUE system hard drive after uninstalling,*

Reinstalling ECx Host Software

If ECx is installed on your VENUE system, you will have to reinstall the ECx host software after performing a System Restore or an Update.

System Restore If you perform a complete System Restore, the ECx host software must be reinstalled from its original installer disc. See “Installing ECx Host Software” on page 251.

Update If you perform an Update, you must still reinstall the ECx host software. You can reinstall without using the ECx installer disc because an Update leaves the ECx installer on your VENUE system’s hard drive. You can also reinstall using the original installer disc.

To reinstall after an Update without using the ECx installer disc:

- 1 Remove any USB key disks from all USB ports, and make sure no installer discs are in the CD-ROM drive.
- 2 Do one of the following to put your system into Config Mode:
 - Press the Console Config switch on the console.
 - or –
 - Double-click the Mode box in the bottom-right corner of the screen.
- 3 Go to the Options > Systems page.

Click the Update button.

Overview of ECx Setup and Configuration

You can control your VENUE system (the “host”) with a remote computer (the “client”) using standard VNC (Virtual Network Computing) protocol over TCP/IP, allowing remote access to your system via a wired or wireless Ethernet-based network. This chapter covers the steps for configuring and using ECx.

For a wired network, the steps include:

- ◆ Connecting the remote computer directly to your VENUE system using an Ethernet cable.
- ◆ Setting the IP addresses of your VENUE system and your client computer manually.
- ◆ Enabling remote operation of your VENUE system.

For a wireless network, the steps include:

- ◆ Connecting a wireless router or a wireless access point (WAP) device to your VENUE system.
- ◆ Setting the IP addresses of your VENUE system and your client computer manually or automatically.
- ◆ Establishing a connection between your wireless router and the client computer.
- ◆ Enabling remote operation of your VENUE system.

Connecting a Computer Directly to VENUE

If you are establishing a fixed remote control station and do not need a mobile connection, you can connect the remote computer directly to your VENUE system using an Ethernet cable.

To connect a computer directly to your VENUE system:

1 Connect one end of the appropriate Ethernet cable type (with RJ-45 connectors) to the ECx port on your VENUE system, and the other end to the Ethernet port on the computer. The type of cable depends on the operating system of the remote computer:

Windows To connect a Windows computer directly to your VENUE system, an Ethernet crossover cable is required. Alternatively, you can use an Ethernet hub and connect standard Ethernet cables between your VENUE system, the hub and the remote computer.

Mac To connect a Mac computer directly to your VENUE system, you can use either a standard Ethernet cable or an Ethernet crossover cable.

2 Configure the VENUE system and the client computer IP addresses manually. See “Setting VENUE and Client IP Addresses Manually” on page 254.

Connecting a Wireless Router or WAP to VENUE

VENUE systems work with standard wireless routers or WAP devices.

Before connecting a wireless router or WAP device, you should configure the SSID of the device so that its wireless network can be easily identified on the client computer. You can specify any unique network name for the device, such as “VENUE Network.”

To configure the SSID and any network security features of your wireless router or WAP, refer to the manufacturer’s instructions.

To connect a wireless router or WAP device to your VENUE system:

1 Connect one end of the appropriate type of Ethernet cable to the ECx port and the other end to the Ethernet connector port on the router or WAP. Do one of the following depending on the type of device you are using

- If you are using a wireless router, use a standard Ethernet cable to your VENUE system.
- or –
- If you are using a WAP, use an Ethernet crossover cable to connect to your VENUE system.

2 Do one of the following:

- If you are using a wireless router or WAP device that does not include a DHCP server function (such as the Cisco Aironet 1230AG), you must configure your VENUE system and the client computer IP addresses manually. See “Setting VENUE and Client IP Addresses Manually” on page 254.
- or –
- If you are using a wireless router that includes a DHCP server function (such as the Belkin Pre-N), you can configure your VENUE system and the client computer to set the IP addresses automatically. See “Setting VENUE and Client IP Addresses Automatically” on page 256.

Setting VENUE and Client IP Addresses

You can set the IP addresses of your VENUE system and client computer manually or automatically. Do one of the following depending on the configuration of your network:

◆ If you are connecting a computer directly to your VENUE system, or you are using a wireless router or WAP device that does not include a DHCP server function, see “Setting VENUE and Client IP Addresses Manually” on page 254.

– or –

◆ If you are using a wireless router that includes a DHCP server function, see “Setting VENUE and Client IP Addresses Automatically” on page 256.

⚠ IP configuration changes on your VENUE system and client computer can take up to 2 minutes to become effective. After making changes, be sure to allow sufficient time for the system to assign IP addresses and establish communication between all the components.

If network communication is not established after allowing sufficient time for IP addressing, then you can verify that you are using the correct cable types, have correctly connected the system, and have working cables.

Setting VENUE and Client IP Addresses Manually

Set VENUE and client computer IP addresses manually if you are connecting a computer directly to your VENUE system, or you are using a wireless router or WAP device that does not include a DHCP server function.

Setting a VENUE System IP Address Manually

To manually set the IP address for your VENUE system:

- 1 In the D-Show software, go to the Options page and click the Interaction tab.
- 2 Under Ethernet Control, click Edit.

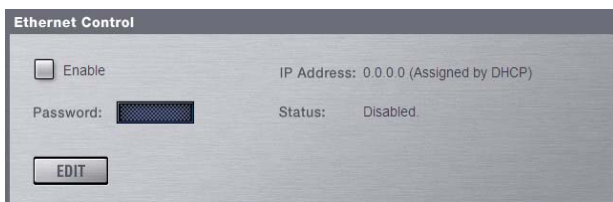

Ethernet Control section of the Interaction page

- 3 Select “Use the Following Address” and enter the following:
 - IP address: 10.0.0.1
 - Subnet Mask: 255.255.255.0
 - Default Gateway: 10.0.0.1



Setting an IP address manually

- 4 Click Apply.
- 5 Select Enable to activate the VENUE ECx host.
- 6 Go to “Setting the Client Computer IP Address Manually” on page 254.



Enabling the VENUE ECx host

Setting the Client Computer IP Address Manually

After manually setting your VENUE system’s IP address, you need to set your client computer’s IP address.

To manually set the IP address in Windows:

- 1 Go to Control Panels > Network Connections.
 - 2 In the Network Connections window, do one of the following:
 - If you are connecting the computer directly to your VENUE system, right-click the Local Area Connection icon and choose Properties.
- or –
- If you are connecting using a wireless router or WAP, right-click the Wireless Network Connection icon and choose Properties.

3 In the Connection Properties window, double-click Internet Protocol (TCP/IP).

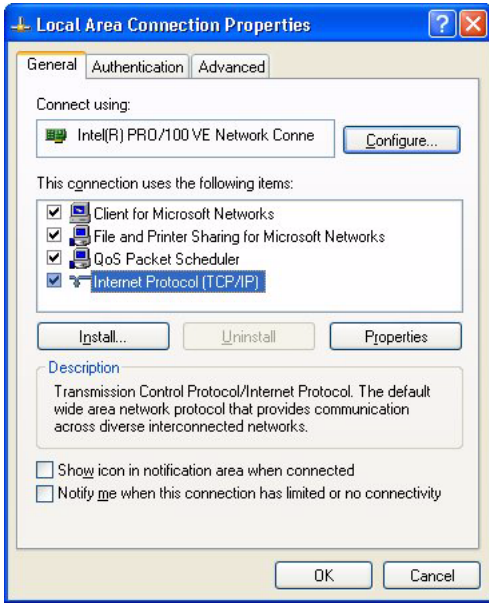

Local Area Connection Properties window

4 In the Internet Protocol Properties window, select “Use the following IP Address” and enter the following:

- IP address: 10.0.0.2
- Subnet Mask: 255.255.255.0
- Default Gateway: (none required)

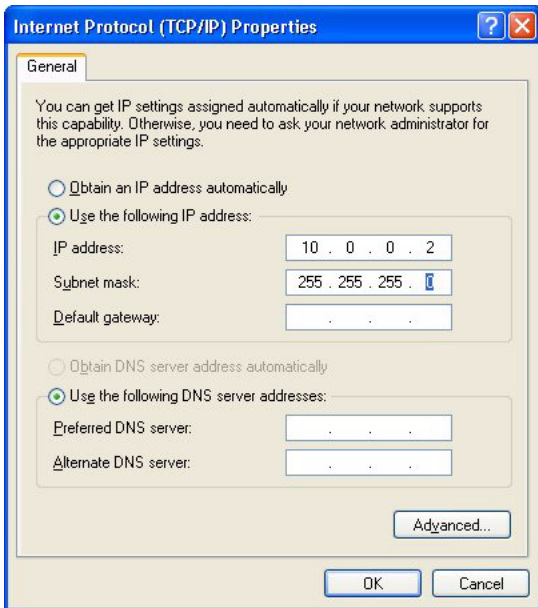

Internet Protocol Properties window

5 Click OK to close the Internet Protocol properties window.

6 Click OK to close the Network Connection Properties window.

7 Do one of the following depending on the configuration of your network:

- If you are using a wireless network, go to “Establishing a Wireless Connection” on page 257.
- or –
- If you are using a wired network, go to “Enabling Remote Operation” on page 258.

To manually set the IP address on a Mac:

1 Launch System Preferences > Network.

2 Do one of the following:

- If you are connecting the computer directly to your VENUE system, choose Ethernet from the network connections services list.
- or –
- If you are connecting using a wireless router or WAP, choose Airport from the network connections services list.

3 Choose Manually from the Configure menu.

4 Enter the following:

- IP address: 10.0.0.2
- Subnet Mask: 255.255.255.0
- Router: (none required)



Network Preferences window

5 Click Apply.

6 Do one of the following depending on the configuration of your network:

- If you are using a wireless network, go to “Establishing a Wireless Connection” on page 257.
- or –
- If you are using a wired network, go to “Enabling Remote Operation” on page 258.

Setting VENUE and Client IP Addresses Automatically

You can configure your VENUE System and client computer to set their IP addresses automatically using DHCP. Set the IP automatically if you are using a wireless router that includes a DHCP server function.

Setting the VENUE IP Address Automatically

To set the IP address of your VENUE system automatically:

- 1 In the D-Show software, go to the Options page and click the Interaction tab.
- 2 Under Ethernet Control, click Edit.

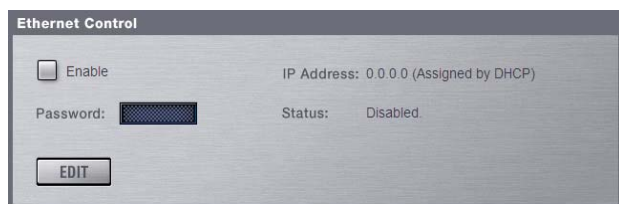

Ethernet Control section of the Interaction page

- 3 Select “Obtain Address Automatically.”

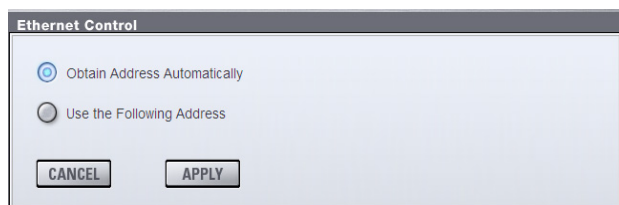

Configuring Ethernet Control in VENUE

- 4 Click Apply.
- 5 Wait until the VENUE System is assigned an IP address. This may take time (up to two minutes). If no DHCP server is found, the VENUE system will self-assign an IP address.

 *Make a note of the IP address assigned to your VENUE system, as you will need to enter it into the client software.*

- 6 Select Enable to activate the VENUE System ECx host. Your system’s status will be displayed as “Waiting for connection.”
- 7 Go to “Setting a Client Computer IP Address Automatically” on page 256.

Setting a Client Computer IP Address Automatically

After setting the IP address for your VENUE system using DHCP, you need to do the same for your client computer.

To automatically set the IP address in Windows:

- 1 Go to Control Panel > Network Connections.
- 2 Right-click the Wireless Network Connection icon and choose Properties.
- 3 In the Connection Properties window, double-click Internet Protocol (TCP/IP).

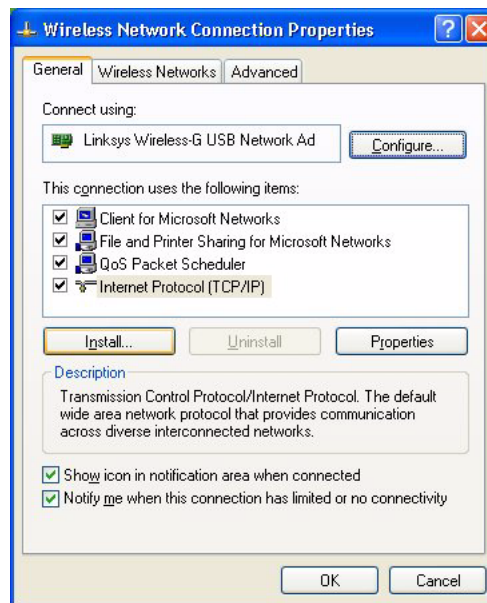

Connection Properties window

- 4 In the Internet Protocol Properties window, select “Obtain an Address Automatically.”

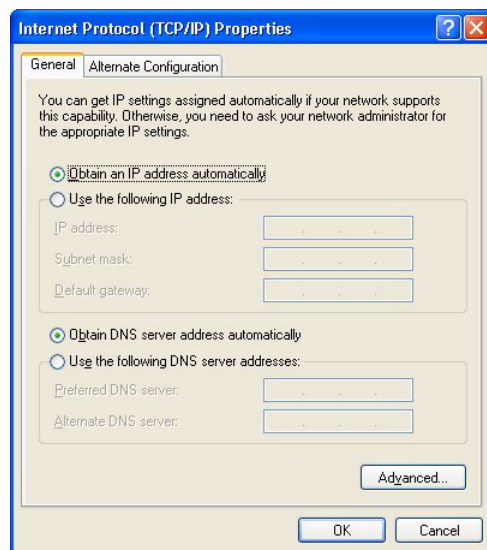

Internet Protocol (TCP/IP) Properties window

- 5 Click OK to close the Internet Protocol properties window.
- 6 Click OK to close the Network Connection Properties window.
- 7 Go to “Enabling Remote Operation” on page 258.

To automatically set the IP address on a Mac:

- 1 Launch System Preferences > Network.
- 2 Choose Airport from the network connections services list.
- 3 Click the Advanced button, then click the TCP/IP tab.
- 4 Choose Using DHCP from the Configure IPv4 menu.

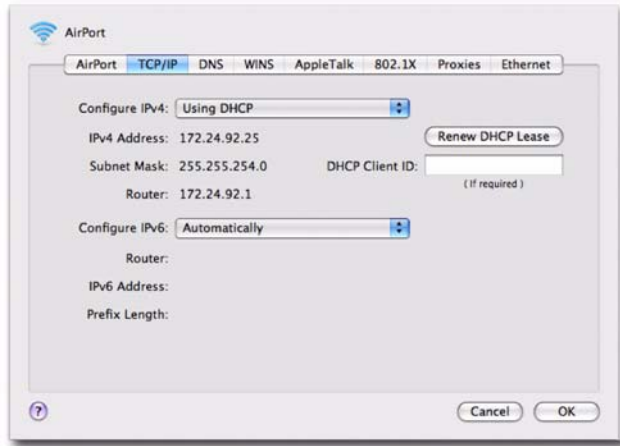

Airport Network Advanced window

- 5 Click OK.
- 6 Go to "Enabling Remote Operation" on page 258.

Establishing a Wireless Connection

Once IP addresses are set, you can establish a connection from the client computer to the wireless network.

To establish a wireless connection in Windows:

- 1 Go to Control Panel > Network Connections.
- 2 Right-click the Wireless Network Connection icon and choose Properties.

- 3 In the Connection Properties window, click the Wireless Networks tab.

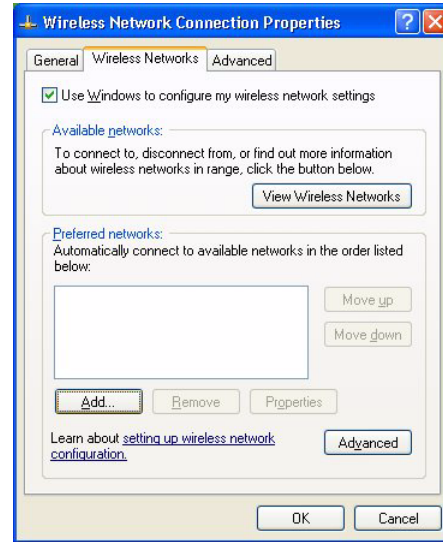

Configuring a wireless connection in Windows

- 4 Under Preferred Networks, click Add, and type the SSID of the wireless router or WAP device connected to your VENUE system.
- 5 Choose the Network Authentication and Data Encryption settings to match the corresponding router or WAP configuration settings.

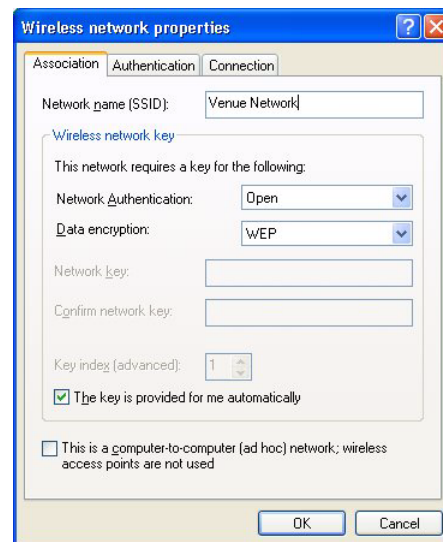

Entering an SSID and choosing settings in Windows

- 6 Click OK. The VENUE SSID should appear in the list of available wireless networks.
- 7 Go to "Enabling Remote Operation" on page 258.

To establish a wireless connection on Mac:

- 1 Go to System Preferences > Network.
- 2 Choose Airport from the network connections services list.
- 3 From the Network Name pop-up menu, choose your network.

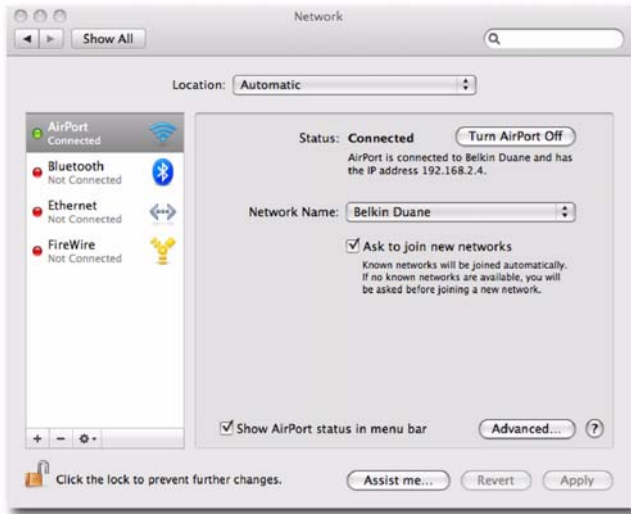

Configuring a wireless connection on the Mac

 *If your network does not appear in the Network Name pop-up menu, choose “Join Other Network, type in the name of your network, and click Join. To assign your wireless router or WAP device a network name, see your device’s documentation.*

- 4 Go to “Enabling Remote Operation” on page 258.

Enabling Remote Operation

In order to enable remote operation of your VENUE system, you need to have obtained valid IP addresses for your VENUE system and your client computer. If you are using a wireless network, you also need to have established a network between the wireless router or WAP device that is connected to your VENUE system and your client computer.

To enable remote operation with a Windows client computer:

- 1 Double-click the “ECx Ethernet Control (UltraVNC Viewer)” icon on your desktop (or go to Start Menu > Programs > UltraVNC > Run UltraVNC Viewer) to launch the UltraVNC Viewer application.
- 2 Enter the IP address of the ECx host (your VENUE system).
- 3 Click Connect.
- 4 Enter the password when prompted (the default VENUE password is “password”) and click Connect.

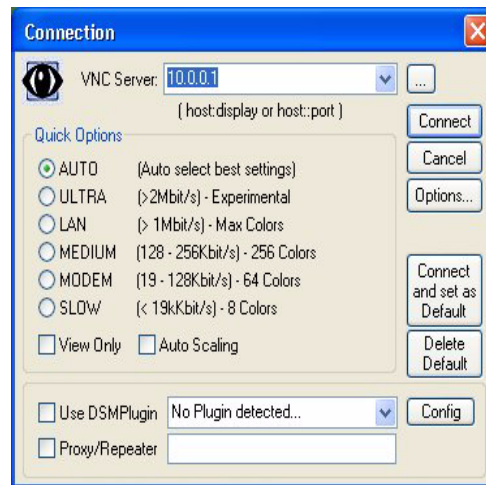

UltraVNC Viewer window

The client launches and displays the VENUE system screen. You can then view and operate all on-screen controls from the client computer.

To enable remote operation with a Mac client computer:

- 1 Double-click the “Chicken of the VNC” icon to launch the application.
- 2 Enter the IP address of the ECx host (your VENUE system).
- 3 Enter the password (VENUE’s default password is “password”) and click Connect.

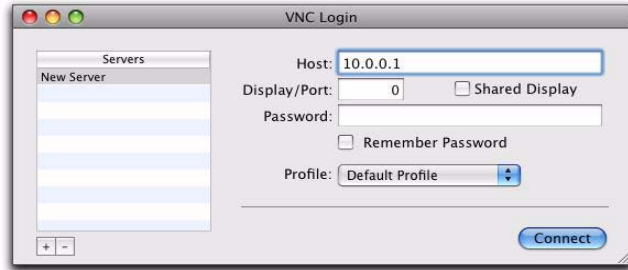

Chicken of the VNC window

The client launches and displays the VENUE system screen. You can then view and operate all on-screen controls from the client computer.

Disconnecting ECx

To disconnect ECx:

- 1 Close the ECx client application by doing one of the following:
 - In Windows, move the pointer to the top of the screen until the control strip appears, and click the close box.
 - or –
 - On Mac, press Command+Q to quit.
- 2 On the VENUE system, deselect Enable in the Ethernet Control section of the Options > Interaction page.

Changing the Ethernet Control Password

You can change the password that users need to enter in order to control your VENUE system from a remote client.

 *By default, the VENUE Ethernet Control password is “password” (all lowercase).*

To change the Ethernet Control password:

- 1 In the Ethernet Control section of the Options > Interaction page, double-click the Password field.
- 2 Enter a new password and press Enter.

 *Make a note of the new password and your system’s IP address, as you will need to enter it into the client software.*

Index

Numerics

0 dBVU 165
1–8 (Bus LED) 25
2-Track 56
48V 72

A

A Unit has gone Offline 243
Absolute (editing snapshots) 190
ACS
 target and channel Select switch 27
 targeting options 58
Actions 205
 creating 210
 list 217
ADAT 111
Add (or Update) this plug-in to Snapshot 165
AES 111
AFL 121
AFL Follows Auxes/Variable Groups 122
All (snapshots) 179
AND (Event List) 208
APAN 26
Assignable Channel Section 28
Assignable Output Encoders 30
Assignable Output Faders 31
attack
 compressor/limiter 137
 expander/gate 138
automation 185
 and Channel Safe 186
 see Snapshots
Automation Safe 58
auto-save and History 176
AUX 26
Aux Sends
 snapshot as monitor, or as effects sends 200
Auxes 93
 banking 43
 configuring busses and Groups 76
 level and pan via Flip to Faders 96
 up to 24 (Var Groups) 93
Auxes/Variable Groups Follow AFL 122

B

backup
 and History 176
 CD-ROM 243
Balance 64
 when pasting 47
ballistics for meters 58, 119
bandwidth
 EQ 144
Bank A–D 39
Bank Safe 40
banking 39, 43
 Group Spill 88
 main and sidecar split banking 39
 outputs 43

banner display 33
bell or shelf EQ 144
Blank Strip 47
blue (snapshot) 181
built-in
 compressor 137
 expander 137
 gate 137
 limiter 137
bus assignment indicators 25
Bus ID 10
bus processors
 assigning plug-ins 160
busses
 Auxes and Var Groups 93
 Groups 87
 linked Matrix stereo 101
 Mains 52
 PQ 100
Busses page 53
bypass
 EQ in out 143
 plug-ins 158

C

C/M
 LED 25
Cancel 32
CD-ROM
 using for Transfer and Filing 225
Center Last Recalled Snapshot 182
Change Target By 58
Channel Name 27, 59
channel number (plug-in rack routing) 158
CHANNEL SAFE 187
Channel Safe 186
channels
 banking 39
 configuring number of 52
 copy and paste 46
 in the Patchbay 109
 layout and numbering via Bus ID 10
 moving 47
 reset shortcut 46
 selecting 43
 type text search 44
Chase MTC 181
Clear 178
Clear Console
 during reset 241
clip
 Hidden Bank Clip 24
 Hidden Bank LED 116
 Hold 120
 Margin 120
clock
 system date and time 57
clock (tempo) 57
clock (word) 20
colors in rack slots 157
COMP 26
Comp/Lim 139
compressor
 side-chain 141

- compressor/limiter
 - adjusting 138
 - attack 137
 - comp knee 137
 - defaults 138
 - Dynamics Graph 140
 - gain reduction meters 137
 - make-up gain 137
 - ratio 137
 - release 137
 - threshold 137
- Config Mode 34
 - and plug-ins 151
- Console 34
- Console Mode switch 34
- Control Surface Change 239
- Control Surface options 59
- controls
 - input and FX return channels 24
- copy and paste
 - channel settings 46
 - dynamics settings 141
 - EQ settings 148
- copying
 - plug-ins 159
- Create new snapshot containing this plug-in 165
- crossfade (snapshots) 199
- Cue on Mains Fader 126
- cursor 57

D

- Date & Time Check 239
- date and time 57
- dBVU, dBu, dBFS 165
- Default 35
 - while unlinked 40
- defaults
 - compressor/limiter 138
- DELAY 26
- delay
 - compensation 82
 - input channel built-in 72
 - mains (house) 82
 - Monitor bus 54, 126
- delay (Event List Wait) 211
- Delay Compensation 55
- Delete (snapshots) 178
- Devices page 53
- Digital/Analog EQ 143
- DigiTest 241
- Dim
 - Talkback dim 56
- Direct Outs
 - from output busses 83
 - routing to plug-ins 161
- Disable
 - snapshots 178
- divergence 82
- Dly (channel Delay in snapshots) 201
- D-Show
 - Standalone software 223
- DSI card (Digital Stage Input) 19
- DSO card (Digital Stage Output) 19
- DSP
 - plug-in allocation tips 52
 - plug-ins 165
- Duplicate 178
- Dyn Pre-EQ 140, 147
- dynamics
 - adjusting 138
 - and plug-ins 140
 - built-in 67
 - comp/lim 138
 - Dynamics Graph 140
 - output LED 30
 - presets for built-in 141
 - reset 139
 - settings and presets 141
 - side-chain 141

E

- ECx 251
 - installing software 251
- Edit (System Config) 51
- Edit mode 190
- encoders
 - output 43
 - split banking 39
- EQ
 - adjusting 144
 - and plug-ins 146
 - bell or shelf 144
 - built-in HPF 143
 - built-in parametric 143
 - bypass via Input Direct mode 140, 147
 - digital/analog 143
 - Dyn Pre-EQ 140, 147
 - GEQ 79
 - in out 143
 - output LED 30
 - parametric 143
 - ranges of controls 150
 - settings and presets 148
- ethernet (see ECx) 251
- Events
 - actions 205
 - and Preview mode 194
 - and Snapshot modes 212
 - and snapshots 212
 - behavior 210
 - creating actions 210
 - creating triggers 208
 - creating, selecting, managing 206
 - defaults 213
 - enabling and disabling 207
 - Event List 204
 - list of action types and properties 217
 - list of trigger types and properties 216
 - reset 211
 - terminology 203
 - testing 211
 - triggers 205
 - Wait 211
 - window 204
- Exp/Gate 139
- expander
 - side-chain 141
- expander/gate
 - adjusting 138
 - attack 138
 - gain reduction meters 138
 - gate range 138
 - release 138
 - threshold 138
- Expert Mode 91
- export patch list 113
- export system info 112

F

- faders
 - and Group Spill 88
 - Flip 26
 - Flip for Send level and pan 96
 - Mains (house) 32
 - reset shortcut 46
 - split banking 39
- feedback 212
- Filing
 - History 176
 - loading Shows 172
 - Presets and Scope Sets 173
 - Show files 172
 - Show Folders 171
- filtering with Recall Safe 185
- Fine 36
 - momentary or latching 36
 - while unlinked 40
- firmware 244
- Flip 26
 - Send level and pan 96

- Footswitch Status (Events) 205
- formats (plug-ins) 159
- Function switches 133
- Function switches (F1, F2, F3, F4) 32
- FX Returns
 - and plug-ins 160
 - banking 39
 - channel controls 24
 - configuring 52

G

- gain
 - and multiple input routing 110
 - Guess 27
 - setting 27
- GATE 26
- gate
 - key source 142
 - range for expander/gate 138
 - side-chain 141
- global modifiers 35
- GPI
 - pulse and duration 210
 - Status display (Events) 205
- Graphic EQs 79
 - configuring 52, 147
- green (snapshot) 181
- Groups
 - and Variable Groups 76
 - banking 43
 - spill 88
 - using 87
 - Variable Groups 93
- Guess (gain) 27

H

- hard knee 137
- hardware
 - display of unavailable 108
- headphones
 - level 126
- hexadecimal 196
- Hidden Bank Clip 116
- hidden bank clip 24
- high-pass filter 143
- History 176
- house (Mains)
 - fader 32
 - mute 131
- HPF 26, 71
- HTML
 - patch list export 113
 - system info export 112

I

- I/O
 - unavailable 108
- iLok 153
 - USB ports 153
- In/Out
 - EQ 143
- INP GN 27
- Input channel numbering 10
- Input Channels 63
- Input Channels and Faders 24
- Input Direct mode 73, 140, 147
- Input Safe Switches
 - changing modes via an Event 213
- inputs
 - 20 dB pad 72
 - analog 15
 - assigning Patchbay routing 65
 - assigning to VCAs 67
 - automation safe 188
 - built-in dynamics 67
 - built-in EQ 67
 - channel controls 24
 - connecting digital 20
 - faders 73
 - HPF 71
 - Input Channels and FX Returns 24, 63
 - Input Direct mode 73, 140, 147
 - make stereo 63

- mute 72
- naming 64
- pan 71
- phantom power 72
- polarity (phase) 72
- routing to Auxes 66
- routing to Mains and Groups 65
- Safe 72
- solo 72
- width 71

- Insert Blank Strip 47
- Insert Mode 162
- insert number (plug-in rack routing) 158
- inserts
 - assigning plug-ins 160
 - on outputs 78
 - output LED 30
- Installed Plug-Ins 151
- Interaction page 58
- invert output phase 80

K

- key assign 142
- key listen 142
- key source 142
- knee
 - hard or soft 137
- knobs
 - rotary and switch functionality 26
 - see encoders

L

- Latch (Event action behavior) 210
- LCDs
 - options 59
- LCR 52
- levels
 - plug-ins 165
- limiter
 - adjusting 138
 - defaults 138
 - side-chain 141
- linked Matrixes 101
- linking
 - screen and console 33, 58
- Lock (System Lock) 34
- locking snapshots 188
- LR
 - LED 25

M

- Main Unit 23
 - split banking 39
- Mains 52
 - configuring 52
 - input routing 65
 - linking 81
- Mains (house) fader 32
- maintenance
 - system restore 243
- Make Stereo
 - and Blank Strips 47
- Make Stereo/Mono 63
 - shortcut 47
 - while unlinked 40
- make-up gain
 - compressor/limiter 137
- Masters and Global section 31
- Matrix
 - and snapshots 106
 - banking 43
 - controls 104
 - input configuration 101
 - linked stereo 101
 - linking and unlinking inputs 102
 - user inputs 103
- Matrix and PQ Sources 101
- Meter Bridge 32
- metering 115
 - ACS 117
 - ballistics and options 119
 - channel meters 115
 - Hidden Bank Clip 116

- outputs 118
 - Selected Channel 118
 - solo 119
- MIDI
 - adding to snapshots 195
 - and Recall Safe 185
 - in Preview mode 194
 - output Safe 196
- MIDI Snapshot Output Safe 222
- Misc page 56
- Mix (Recall Safe parameters) 187
- Mix Engines 52
- modes (Config versus Show) 34
- Mon (Aux sends and Variable Groups) 200
- Monitor
 - assignable output 124
 - Bus Delay 54
 - Delay 126
 - level 126
 - on Mains fader 126
- More Options (during resume) 241
- mouse settings 57
- Move Selected Strip Here 47
- moving plug-ins 159
- MTC
 - chase 181
 - configuring options 56
 - Events and Preview mode 194
 - in Preview mode 194
- Multi 35
- Multi-Assign 44
- Multi-Select 35
 - while unlinked 40
- Mute
 - channels, Mute Groups and VCAs 132
 - Groups 131
 - input channels 72
 - Mains (house) 131
 - outputs 81, 131

N

- name (channel display) 27
- naming channels 64
- navigating 39
- near-field levels 126
- New 178
- next (snapshot) 180
- None (snapshots) 179
- Notes (snapshots) 183

O

- offset
 - Right Offset 71
- On (Recall Safe) 185
- One or More Units have Failed 238
- operating modes 34
- Options 51
 - Busses 53
 - Control Surface interaction 59
 - Devices 53
 - Interaction 58
 - Misc 56
 - Pickoffs 55
 - Plug-Ins 151
 - Snapshots 55
 - System (configuration) 51
 - viewing angle 59
- OR (Event List) 208
- oscillator 130
 - settings 56
- Other (plug-in formats) 159
- Output encoders
 - and plug-ins 162
- outputs
 - analog 15
 - and mute 131
 - automation safe 188
 - Auxes 75
 - banking 43
 - configuring 75
 - delay 82
 - divergence 82
 - graphic EQ 79
 - Groups 75

- Mains 75
- Matrix 76
- metering 118
- mute 81
- PQ Personal Q 76
- reassigning in Patchbay 111
- routing 77
- using inserts 78
- Variable Groups 76

P

- pad 72
- padlock (snapshots) 188
- Pan 71
- pan
 - divergence 82
 - see also Width 71
 - snapshot crossfade 55
 - when pasting 47
- Pan, Balance & Width 199
- PANBAL 27
- panning
 - 3-across-the-front 52
- parameters 106
- parametric EQ 143
- Patchbay
 - displays and indicators 108
 - export patch list 113
 - navigating 109
 - overview 107
 - route multiple via click and drag 110
 - source and destination display 108
 - warning when reassigning 111
- Patching Grid 108
- Peak Hold 119
- Peak mode (metering) 119
- Personal Q 106
- PFL 121
- phantom power 72
- phase (output) 80
- pickoffs 55
 - Dir Outs to plug-ins 161
 - Matrix and PQ 101
- Plug-In Racks are Ready 241
- Plug-In Racks Need Reset 241
- plug-ins 151
 - allocating DSP 52
 - and channel Direct Outs 161
 - and Recall Safe 185
 - and snapshots 164
 - and standalone software 223
 - assigning to rack slots 159
 - Config and Show mode 151
 - Dir Out pickoffs 161
 - display options 162
 - display unavailable and inactive 157
 - enabling and disabling 154
 - EQ 146
 - in Preview mode 194
 - in/out (bypass) 158
 - Insert Mode views 162
 - list and menu management 154
 - managing 154
 - mono, stereo 159
 - moving and copying 159
 - on outputs 78
 - on the control surface 162
 - on-screen 163
 - pinning a view 164
 - preset files 164
 - rack slots 157, 158
 - racks 156
 - re-initializing the racks 241
 - routing to and from 160
 - snapshot indication (red) 158
 - Source switch 162
 - targeting 162
 - Use Racks 241
 - views 156
- Plug-ins to Install 151
- polarity (input) 72
- polarity (output) 80
- power
 - start up/shut down guidelines 18

Power Supply Alert 239

PQ

- and snapshots 106
- banking 43
- controls 104
- input configuration 101
- linking and unlinking inputs 102
- user inputs 103

Pre (snapshot parameters) 200

presets

- dynamics 141
- EQ 148
- folders 173
- for built-in dynamics 141
- managing 174
- plug-ins 164
- Scope Sets 187
- transferring 175

Preview mode 192

- and plug-ins 194
- and Undo 193
- capabilities and overview 193
- MIDI and MTC 194

previous (snapshot) 180

Propagate mode 191

Pulse and Duration (GPI) 210

Push-Pin (plug-in view) 164

Q

Q 144

R

rack slots 156

racks 156, 241

ratio

- compressor/limiter 137

Ready to Resume 240

Recall 178, 184

- Next 181
- Previous 181
- Safe 185

Recall Safe 185

- and MIDI 185
- and plug-ins 185
- and Preview mode 193
- CHANNEL SAFE 187
- Matrix and PQ 187
- turning on and off 185
- using 186

recovery 241

red (snapshot) 181

red plug-in rack 158

registration 8

Relative (editing snapshots) 190

release

- compressor/limiter 137
- expander/gate 138

remote control (ECx) 251

Remove this plug-in in Snapshot 165

reset 240

- dynamics 139

Reset (strip) 46

reset a section or parameter 35

Reset Fader 46

Reset Mix Engines 241

resolution (see Fine)

restart 240

restore (software) 243

Resume Operations 240

RGHTGN 27

right-click shortcuts 46

RMS mode 119

rotary encoders

- rotary and switch functionality 26

routing

- assigning channels in the Patchbay 110
- channel bus indicators 25
- Monitor bus 124
- multiple D-Show channels to a hardware output 111

S

Safe

- Automation 58
- Recall Safe 185
- Solo 58
- using channel automation safe 188

Safe All 188

Safe Selected 188

Sample rate conversion 19

sample rate conversion 19

save (History auto-save) 176

Scope Sets

- transferring 175
- using 187

security (System Lock) 34

Select

- channel switch 27

Selected Chan

- options 58

selecting channels 43

settings

- dynamics 141
- EQ 148
- plug-ins 164
- shelf or bell EQ 144
- shortcuts 35
- right-click 46
- Snapshots 182

Show files 171

- creating 171
- deleting 171
- Folders 171
- loading 172
- transferring 175

Show Folder 171

Show Mode 34

Show VCA Contribution 85

Shows

- and plug-in management while loading 154

Sidecar 23

- split banking 39

side-chain 141

- assigning for plug-ins 161
- assigning source (gate only) 142

signal routing

- display in Patchbay 108
- inputs 65

Simple Mode 91

SIP 121

Snapshots

- adding MIDI messages 195
- adding plug-in data 197
- All 179
- and Channel Safe 186
- Center Last Recalled in list 182
- Channel Safe 187
- channel scope 178
- chase MTC 181
- classifying Auxes and Var Groups 200
- Clear 178
- color indication in List 181
- creating 183
- crossfade 199
- data type buttons 178
- Delete 178
- Disable 178
- Duplicate 178
- Edit mode 190
- Events and Preview mode 194
- faders 179
- from the console 180
- in Preview mode 193
- keyboard shortcuts 182
- List 178
- list of data types and parameters 201
- locking and unlocking 188
- managing (storing, clearing, deleting, moving, duplicating) 188
- MIDI and plug-ins in Preview mode 193
- naming and renaming 183
- New 178
- Next 180
- None 179
- notes 183
- overview 177
- pan crossfade 55

- plug-in menu 164
- plug-in scope indication 158
- Preview (editing and previewing snapshots) 192
- Preview mode F key 133
- Previous 180
- Propagate mode (updating snapshot parameters) 191
- Recall 178
- Recall Safe 185
- recalling 184
- safe filter (Recall Safe) 186
- Scope Sets 187
- selecting 182
- Store 178
- target 184
- type text search 44
- Snapshots containing this plug-in 164
- Snapshots page 55
- soft knee 137
- software
 - overview of pages and tabs 37
 - standalone 223
 - system restore 243
 - updating 243
- Solo
 - AFL, PFL, SIP modes 121
 - and key listen 142
 - input channels 72
 - metering 119
 - on-screen settings 54
- solo
 - Cue on Mains Fader 126
 - solo safe 123
- Solo Safe 58
- Source 27, 162
- spill
 - Groups 88
 - VCA's 85
- Stage Rack
 - enabling 2 18
- standalone software 223
 - and plug-ins 223
 - export System Info 112
 - installing and removing 223
 - system requirements 223
- stereo
 - spread (Bal/Width) 64
- stereo channels (see Make Stereo) 63
- stereo plug-ins 159
- Store 178
- sync
 - plug-in tempo 57
- synchronizing digital sources 20
- System 51
- system clock 57
- System Config 51
- system info export 112
- System Lock 34
- System Update and Restore CD 243

T

- takeover from backup mode 240
- Talkback
 - dim level 56
- Tap Tempo 57, 218
- target
 - channel Select switch 27
 - channels 43
 - plug-in 162
- Targeting Changes View Mode 58
- tempo
 - snapshots 196
- text
 - export patch list 113
 - system info export 112
- threshold
 - compressor/limiter 137
 - Expander/Gate 138
- time of day 57
- Tool Tips 33
- Trackball 32
 - settings for 57
- transfer 175

- Triggers 205
 - creating 208
 - list 216
- troubleshooting
 - plug-ins 154
 - restore and replace all software 243
- Type Text search 44

U

- Undo
 - in Preview mode 193
 - via History 176
- Update this plug-in in Snapshot 165
- updating D-Show software 243
- USB
 - ports for iLoks 153
- Use Racks 241
- User 36
- User Inputs (Matrix/PQ) 103

V

- Variable Groups 93
 - level and pan via Flip to Faders 96
 - snapshot as monitor, or as effects sends 200
- VCA's
 - and snapshots 201
 - assigning 84
 - banking 43
 - mute 131
 - showing effective gain 84
 - spill 85
 - using 85
- View Modes 32
- voltage 7

W

- Wait (Event List) 211
- While Active (Event action behavior) 210
- WIDTH 27
- Width 71
- width (when pasting) 47
- wireless (ECx) 251
- word clock 20

X

- XOR (Event List) 208

Y

- yellow (snapshot) 181

Z

- zero
 - see Clear Console



www.digidesign.com

DIGIDESIGN
2001 Junipero Serra Boulevard
Daly City, CA 94014-3886 USA

TECHNICAL SUPPORT (USA)
Visit the Digidesign Online Support Center
at www.digidesign.com/support

PRODUCT INFORMATION
For company and product information,
visit us on the web at www.digidesign.com